



ACOUSTIC ROOMS

www.b2bofficeinteriors | ph: 01-4610300 | mail@b2b.ie



NUA

ACOUSTIC



ACOUSTIC ROOMS

WHAT
YOU

VE
VE
M

NUA



Silence in every detail, peace and comfort.



AKO 10 1000

Acoustic Rooms offer the fastest way to create individual workspaces in open-plan office environments.



AKO 10 2200

Thanks to the Acoustic Rooms designed in different sizes, you can hold meetings either individually or in Acoustic Rooms for two or four people.



AKO 20 2200

Acoustic Rooms adapt to any office environment with different color options and modern designs.



Acoustic Rooms create a pleasant atmosphere for meetings with suitable furniture.

Soundproof Layers |



1-Sheet Steel |

High quality powder coated metal side panels.

2-Steel Barrier |

Barriers designed to strengthen the side panels.

3-EPDM Sponge |

It has a very good sound insulation performance.

4-Empty Space |

According to academic studies, it has been concluded that acoustic products made by leaving an air gap between the layers provide the best acoustic performance at all frequencies.

5-Wood Panel |

It is a wooden board with very good mechanical strength.

6-Acoustic Foam |

Absorb sound, echo and vibration, High frequency tones up to 80% and low frequency tones completely.

7-Acoustic Felt |

With its special acoustic fiber structure, it is extremely resistant to impacts, cracks, dismantling and wear. Its rough surface absorbs the sound waves in the acoustic space.

8-Decorative Front Frame |

Decorative front frame made of high-quality electrostatically powder-coated aluminum.

9-Protective Cover |

Thanks to the 30 mA leakage current relay in the safety zone, the power supply is automatically interrupted if there is a risk of a leak in the acoustic booth, and safety is guaranteed.

10-Air Ducts |

It allows fresh air from outside to enter the Acoustic Room.

Details |

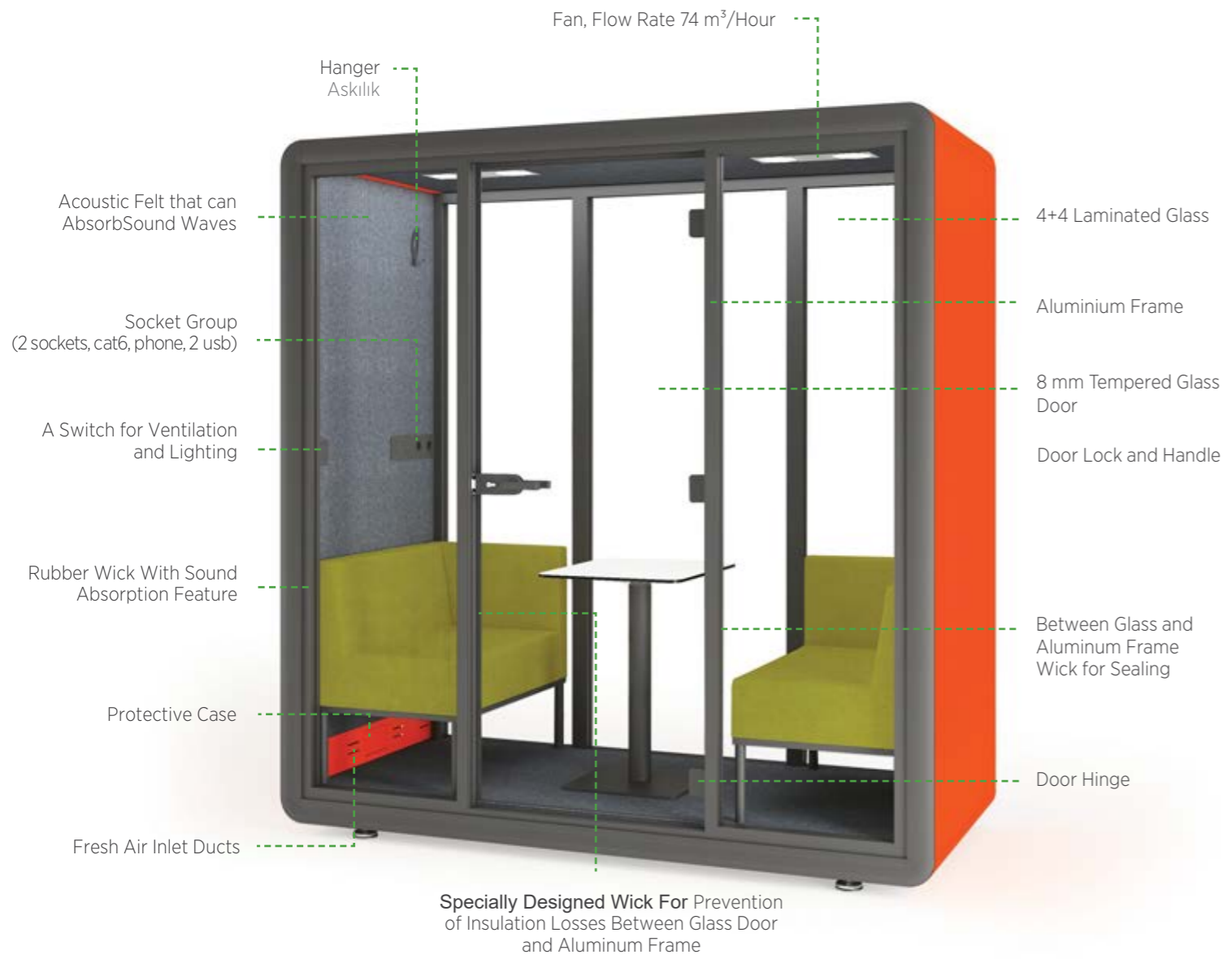

After determining the position of the Acoustic Room, it can be fixed with adjustable feet with vibration damping feature. High weight-resistant wheels provide easy displacement.

Optional |
If desired, the socket group can be mounted on the floor.

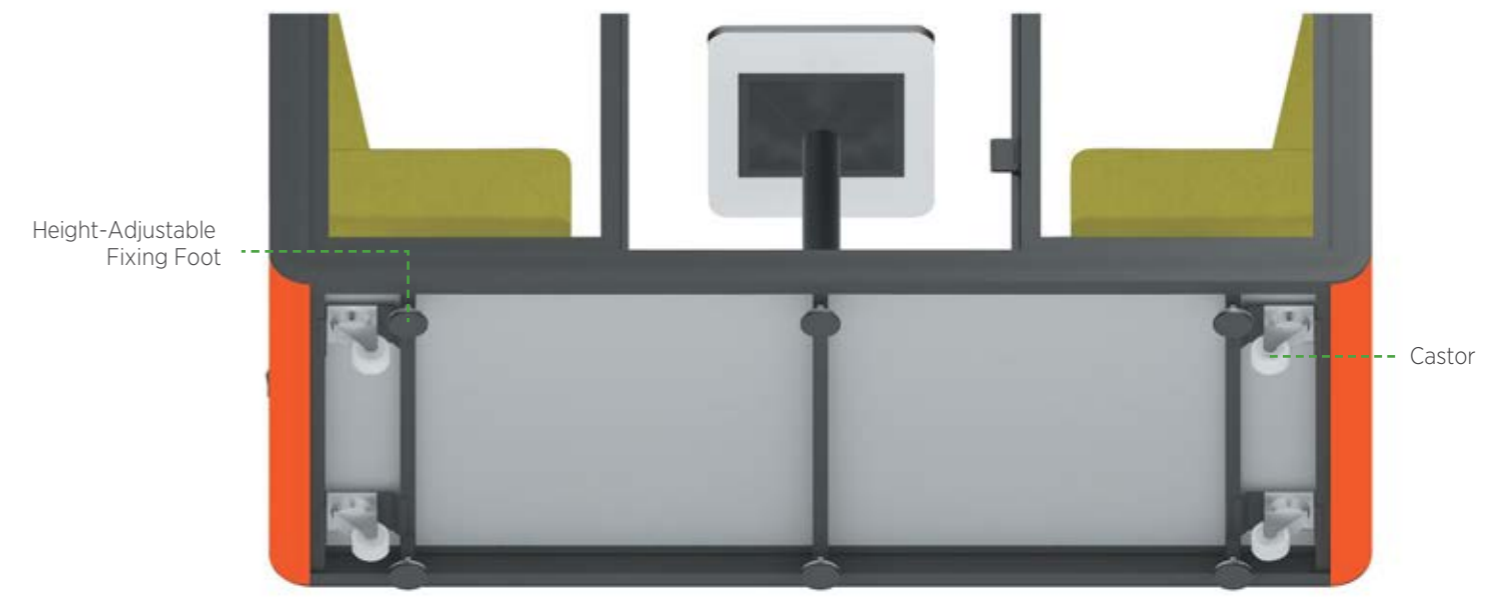
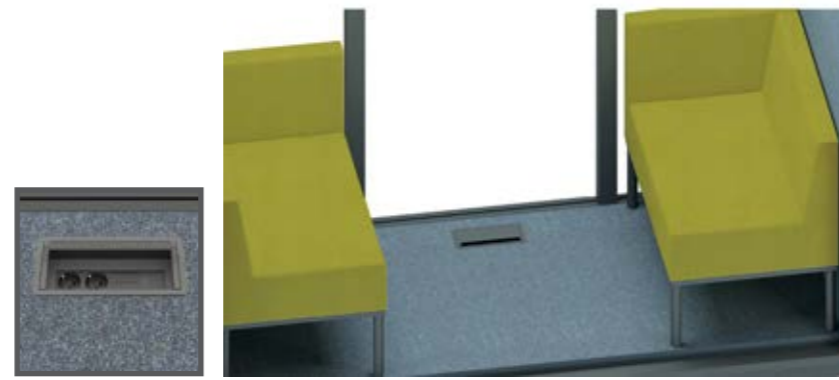

Exterior Colors |



RAL 6018
Green



RAL 1013
Cream



RAL 3003
Burgundy



RAL 7021
Anthracite



RAL 2008
Orange

Upholstery Colors |

Fabric |

Prime Series |



2205
Ocher



2210
Orange



2215
Green



2220
Turquoise



2225
Camel



2230
Violet



2235
N. Blue



2240
Red

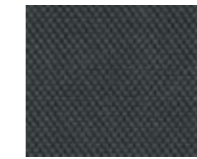

2250
Grey

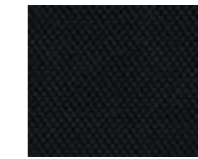

2255
Black

Drop Series |



1680
Brown



1687
Orange



1684
Red



1689
Turquoise



1682
Blue



1688
Burgundy | Bordo



1685
Grey

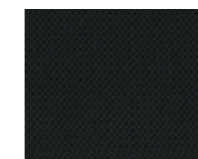

1686
Black

Leather |

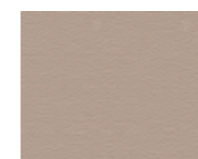

1240
Clay



1505
Turquoise

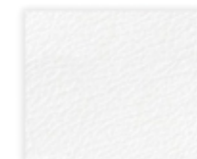

6096
White



1510
Dark Green

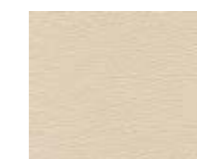

1220
Bej



6136
Green



6125
Red



6080
Blue



6150
Camel

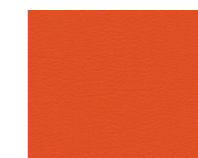

6170
Orange

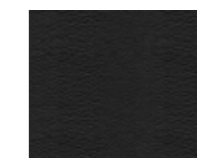

6105
Black



6146
Burgundy

Dimensions |

AKO 10 1000

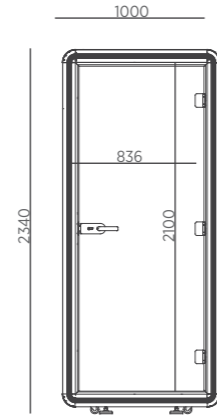
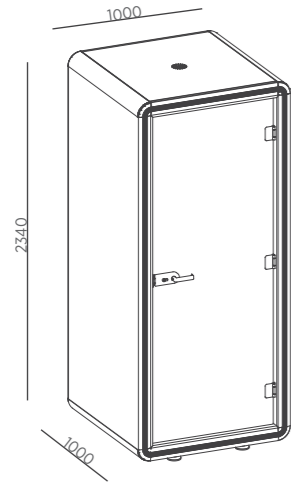

For 1 Person |
 2x9W 620 lm low electricity consumption led spotlight
 1 fan

AKO 10 2200

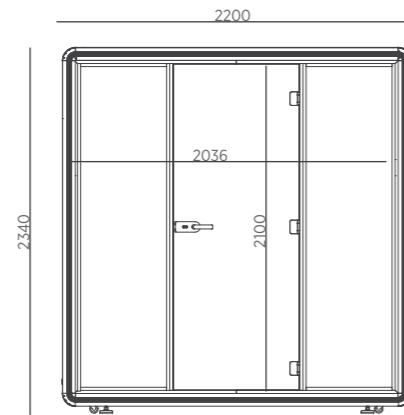
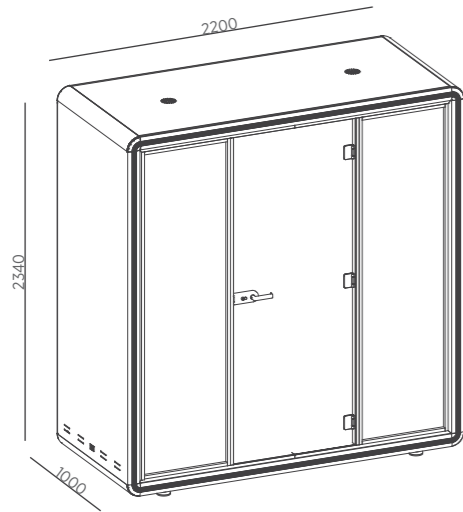

For 2 Persons |
 4x9W 620 lm low electricity consumption led spotlight
 2 fans

AKO 20 2200

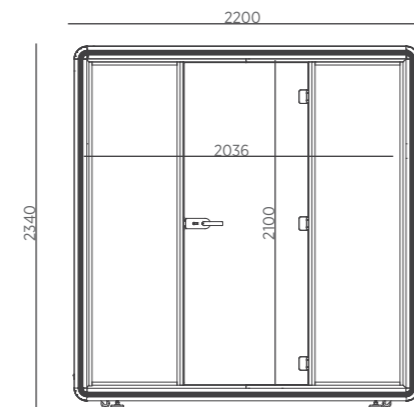
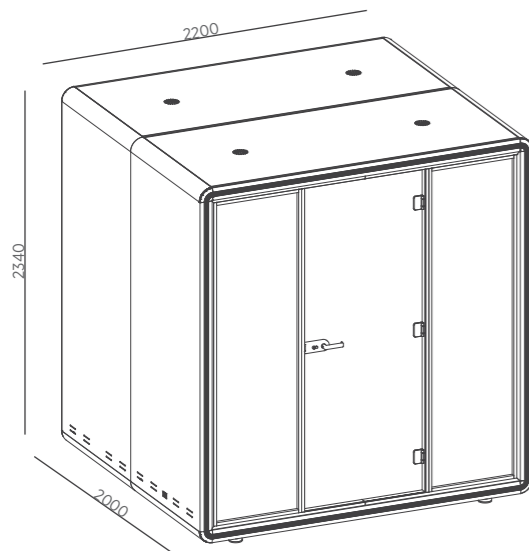

For 4 Persons |
 8x9W 620 lm low electricity consumption led spotlight
 2 fans

Technical Specifications |

	Internal Width(mm)	Depth (mm)	Height(mm)
For 1 Person	1000	1000	2340
For 2 Person	2200	1000	2340
For 4 Person	2200	2000	2340

	Internal Width(mm)	Internal Depth(mm)	Internal Height(mm)
For 1 Person	836	852	2100
For 2 Person	2036	852	2100
For 4 Person	2036	1824	2100

Structure

Lacquered side panels made of reinforced sheet metal, coated with high quality electrostatic powder
 Electrostatically powder-coated aluminum profile acoustic cabin frame 80 mm wide 4 + 4 laminated glass with aluminum frames at the front and rear
 Glass door 8mm hardened impact resistant
 Lower and upper frame reinforced with steel profiles
 Weight-resistant lower wheels make it easier to move the acoustic cabin
 The inner surfaces of the cabins are covered with acoustic felts, extremely resistant to impacts, cracks, sound absorption is ideal

Electrical System

3 m long with plug so that the system can be easily connected to the office electrical system
 Main switch and AC power input socket with fuse
 30 mA leakage current relay which automatically cuts the electricity to the acoustic cabinet in the event of an electrical leak and prevents possible dangers

2x9W 620 lm low electricity consumption led spotlight for single room
 4x9W 620 lm low electricity consumption led spotlight for double room
 8x9W 620 lm low electricity consumption led spotlight for quadruple room
 2 sockets, 1 cat6 socket, 1 telephone socket, 2 USB port and 1 switch for lighting and ventilation system

Ventilation System

Quiet fan with an air flow rate of 74 m³/hour
 1 fan in the cabin for one person
 2 fans in the double cabin
 2 fans in the four-compartment cabin
 The fans are activated by the switch

Sound Insulation

During the measurements of the National Metrology Institute TÜBİTAK according to ISO 23351-1, the speech attenuation value was measured with 32 dB and **the value** 20,8 dB at a frequency of 8000 hz.

NUA



ph:01-4610300 | www.b2bofficeinteriors | mail@b2b.ie