

made design

MAKING *DETAILS* EXCEPTIONAL

NEWS 2023

made design

Contract**4**

Zao	6
Niseko	10

Planters**14**

Naka	16
Nipori	20
Kyoto	24

Designers**28**

Technical data**32**

Contract

Zao

6

Niseko

10

by Stone Designs

The new bench that combines seat and planter for both indoor and outdoor spaces. Various configurations, multiple colours and the possibility of an upholstered seat or wooden seat. You decide the space and we provide you with a rest area that breathes nature. Sit back and breathe.

La nueva bancada que combina asiento y jardinera para espacios tanto de interior como exterior. Diversas configuraciones, múltiples colores y posibilidad de asiento tapizado o madera. Tú decides el espacio y nosotros te ponemos un área de descanso que respira a naturaleza. Acomódate, y respira.

Le nouveau banc qui combine siège et jardinière pour les espaces intérieurs et extérieurs. Différentes configurations, plusieurs couleurs et la possibilité d'un siège rembourré ou en bois. Vous décidez de l'espace et nous vous offrons une zone de repos qui respire la nature. Asseyez-vous et respirez.

La nuova panchina che combina seduta e fioriera per spazi interni ed esterni. Varie configurazioni, molteplici colori e la possibilità di avere una seduta imbottita o in legno. Voi decidete lo spazio e noi vi forniamo un'area di riposo che respira natura. Sedetevi e respirate.



More about Zao

DESIGNER
Stone Designs

YEAR
2023

LINE SKETCH

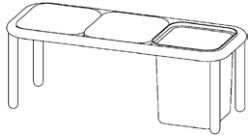

PRODUCT

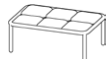
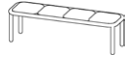

REFERENCE

ZAO 02
*STRUCTURE ONLY

ZAO 03
*STRUCTURE ONLY

ZAO 04
*STRUCTURE ONLY

ZAO 04C
*STRUCTURE ONLY

ZAO 06
*STRUCTURE ONLY

ZAO 09
*STRUCTURE ONLY

SIZE

85 x 47,5 x 45 cm
33,4 x 18,7 x 17,7 in

122,5 x 47,5 x 45 cm
48,2 x 18,7 x 17,7 in

160 x 47,5 x 45 cm
63 x 18,7 x 17,7 in

85 x 85 x 45 cm
33,4 x 33,4 x 17,7 in

122,5 x 85 x 45 cm
48,2 x 33,4 x 17,7 in

122,5 x 122,5 x 45 cm
48,2 x 48,2 x 17,7 in

PRODUCT



REFERENCE

ZAO 15
*PLANTER
50 L / 13,2 G

ZAO 20
*TEXTIL

ZAO 25
*WOOD

*CHOOSE YOUR COMBINATION

SIZE

37 x 37 x 45 cm
14,5 x 14,5 x 17,7 in

37 x 37 x 5 cm
14,5 x 14,5 x 1,9 in

37 x 37 x 3 cm
14,5 x 14,5 x 1,2 in

DETAILS

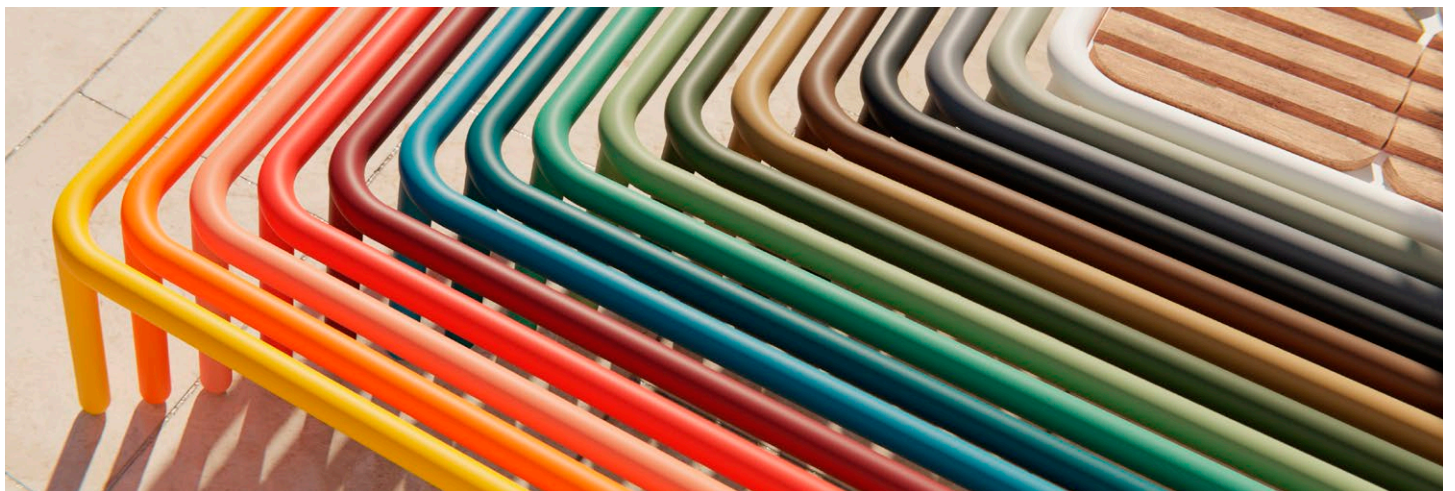

TEXTIL / WOOD
RANGE 16 COLORS

CONTRACT

LACQUERED COLOURS

- BL · Ral 9003 ● VD · Ral 6000
- CE · Ral 7033 ● PE · Ral 5020
- GR · Ral 7015 ● AZ · Ral 5009
- AN · Ral 7016 ● BD · Ral 3005
- MA · Ral 8014 ● RJ · Ral 3026
- OP · Ral 1036 ● RS · Ral 2012
- VF · Ral 6020 ● AM · Ral 1007
- VO · Ral 6011 ● NJ · Ral 2017

TEXTILE COLOURS

- VDC · FEROE 160 ● RS · FEROE 90
- VDO · PATTAY 90 ● RJ · PATTAY 60
- AZC · FEROE 190 ● BD · CAPRI 150
- GR · FEROE 280 ● AZO · MADEIRA 390

CUSTOMISE OPTIONS

- COLOUR

HUMAN PERCEPTION

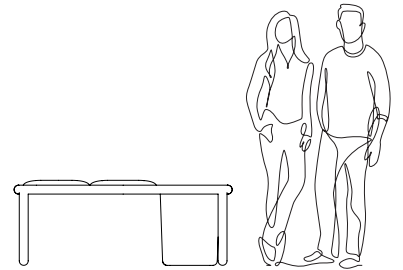

DIFFERENT COMBINATIONS

Niseko

CONTRACT

by Ferran Guimerà

Modular system of configurable seats ideal for interior open spaces. Thanks to the trapezoidal shape of its single piece, it can be adapted to any space according to each need. The module can become an upholstered seat, planter or recycling container. Its optional side table combines with the set and provides functionality.

Sistema modular de asiento configurable ideal para espacios abiertos interiores. Gracias a la forma trapezoidal de su única pieza permite adaptarse a cualquier espacio según cada necesidad. El módulo puede convertirse en asiento tapizado, jardinera o contenedor de reciclaje. Su mesita auxiliar opcional combina con el conjunto y aporta funcionalidad.

Système de sièges modulaires configurables idéal pour les espaces ouverts intérieurs. Grâce à la forme trapézoïdale de sa pièce unique, il peut être adapté à n'importe quel espace en fonction de chaque besoin. Le module peut être transformé en siège rembourré, en jardinière ou en poubelle de recyclage. Sa table d'appoint optionnelle se combine avec l'ensemble et ajoute de la fonctionnalité.

Sistema di sedute modulari configurabili ideale per gli spazi aperti interni. Grazie alla forma trapezoidale del suo singolo pezzo, può essere adattato a qualsiasi spazio in base alle esigenze. Il modulo può essere trasformato in una seduta imbottita, in una fioriera o in un contenitore per il riciclaggio. Il tavolino opzionale si abbina al set e aggiunge funzionalità.



More about Niseko

DESIGNER
Ferran Guimerà

YEAR
2023

LINE SKETCH

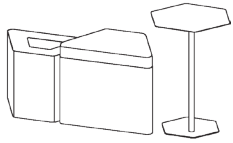

PRODUCT



REFERENCE

NSK 10

SIZE

56 x 35 x 40 cm
22 x 13,7 x 15,7 in

NSK 15

*TEXTIL

56 x 35 x 10 cm
22 x 13,7 x 3,9 in

NSK 20

*PLANTER

56 x 35 x 40 cm
22 x 13,7 x 15,7 in

NSK 30

*TRASH

56 x 35 x 40 cm
22 x 13,7 x 15,7 in

PRODUCT



REFERENCE

NSK 40

SIZE

49 x 43 x 66 cm
19,3 x 17 x 26 in

DETAILS



TEXTIL SEATS
TABLE, WASTEBASKET, PLANTER AND SEAT



DIFFERENT COMBINATIONS

CONTRACT

LACQUERED COLOURS

- BL · Ral 9003 ● VD · Ral 6000
- CE · Ral 7033 ● PE · Ral 5020
- GR · Ral 7015 ● AZ · Ral 5009
- AN · Ral 7016 ● BD · Ral 3005
- MA · Ral 8014 ● RJ · Ral 3026
- OP · Ral 1036 ● RS · Ral 2012
- VF · Ral 6020 ● AM · Ral 1007
- VO · Ral 6011 ● NJ · Ral 2017

TEXTILE COLOURS

- VDC · FEROE 160 ● RS · FEROE 90
- VDO · PATTAY 90 ● RJ · PATTAY 60
- AZC · FEROE 190 ● BD · CAPRI 150
- GR · FEROE 280 ● AZO · MADEIRA 390

CUSTOMISE OPTIONS

- COLOUR
- PICTOGRAMS

HUMAN PERCEPTION

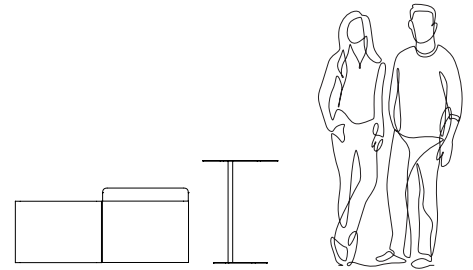

RANGE 16 COLORS / RANGE 8 TEXTIL COLORS

Planters

Naka	16
Nipori	20
Kyoto	24

Naka

PLANTERS

by Gauzak

This particular room divider in the shape of a planter can be placed in a friendly and fun way in any indoor or outdoor space. Its main characteristic is to separate, distance and create cosy spaces in a subtle way. You can plant natural and artificial plants or huge metal or recycled PET leaves with sound-absorbing properties.

Este particular separador de espacios con forma de jardinera, permite ubicarse de manera simpática y divertida en cualquier espacio tanto interior como exterior. Separar, distanciar y crear espacios acogedores de manera sutil es su principal característica. Puedes sembrar plantas naturales y artificiales o unas enormes hojas metálicas o de PET reciclado con propiedades fonoabsorbentes.

Ce séparateur de pièce en forme de jardinière peut être placé de manière conviviale et amusante dans n'importe quel espace intérieur ou extérieur. Sa principale caractéristique est de séparer, d'éloigner et de créer des espaces agréables de manière subtile. Vous pouvez y planter des plantes naturelles ou artificielles ou d'immenses feuilles en métal ou en PET recyclé aux propriétés insonorisantes.

Questo particolare divisorio a forma di fioriera può essere collocato in modo simpatico e divertente in qualsiasi spazio interno o esterno. La sua caratteristica principale è quella di separare, distanziare e creare spazi accoglienti in modo discreto. Si possono piantare piante naturali e artificiali o enormi foglie di metallo o PET riciclato con proprietà fonoassorbenti.



More about Naka

DESIGNER
Gauzak

YEAR
2023

LINE SKETCH

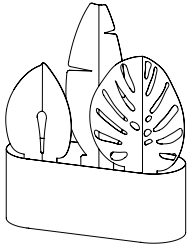

PRODUCT



REFERENCE

NAK 01
*FOR METALLIC
OR PET LEAVES

NAK 02
*FOR METALLIC
OR PET LEAVES

NAK 05
*FOR PLANTS

NAK 07
*FOR PLANTS

SIZE

102 x 35 x 40 cm
40,1 x 13,7 x 15,7 in

102 x 35 x 80 cm
40,1 x 13,7 x 31,4 in

102 x 35 x 40 cm
40,1 x 13,7 x 15,7 in

102 x 35 x 80 cm
40,1 x 13,7 x 31,4 in

PRODUCT



REFERENCE

NAK 10 *METAL
NAK 20 *PET

NAK 11 *METAL
NAK 21 *PET

NAK 12 *METAL
NAK 22 *PET

SIZE

66 x 38 cm
25,9 x 14,9 in

101 x 34 cm
39,7 x 13,3 in

77 x 55,5 cm
30,3 x 21,8 in

DETAILS



METAL LEAVES
LEAVES IN PET MATERIAL



PLANTER

PLANTERS

LACQUERED COLOURS

- BL · Ral 9003
- CE · Ral 7033
- GR · Ral 7015
- AN · Ral 7016
- MA · Ral 8014
- OP · Ral 1036
- VF · Ral 6020
- VO · Ral 6011
- VD · Ral 6000
- PE · Ral 5020
- AZ · Ral 5009
- BD · Ral 3005
- RJ · Ral 3026
- RS · Ral 2012
- AM · Ral 1007
- NJ · Ral 2017

PET COLOURS

- BO-00
- GM-08
- GM-92
- GS-96
- NO-00
- BE-02
- BE-32
- AZ-05
- AZ-25
- AM-90
- IL-18
- NR-09
- RO-60
- RS-31
- RS-67
- VR-07
- VR-11
- VR-25

CUSTOMISE OPTIONS

- BODY COLOUR
- PICTOGRAMS

HUMAN PERCEPTION

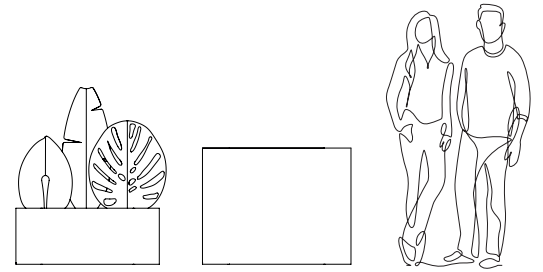

2 PLANTERS / 40CM & 80CM



RANGE COLORS / METALLIC & PET

Nipori

PLANTERS

by Stone Designs

Concave or convex. What has been the planter of a lifetime... plus an inverted version. Made of lacquered sheet metal in 16 available colours, it is ideal for setting up areas in indoor or outdoor spaces. S, M, L and XL are its 4 sizes so that you can place them as best suits your space.

Cóncava o convexa. Lo que viene siendo la maceta de toda la vida... más una versión invertida. Fabricada en chapa metálica lacada con 16 colores disponibles, es ideal para configurar áreas en espacios interiores o exteriores. S, M, L y XL son sus 4 tallas para que las ubiques como mejor le sienta a tu espacio.

Concave ou convexe. Ce qui a été le bac à plantes de toute une vie... plus une version inversée. Réalisé en tôle laquée en 16 couleurs disponibles, il est idéal pour aménager des espaces à l'intérieur ou à l'extérieur. S, M, L et XL sont ses 4 tailles pour que vous puissiez les placer au mieux dans votre espace.

Concavo o convesso. Quella che è stata la fioriera di una vita... più una versione rovesciata. Realizzata in lamiera laccata in 16 colori disponibili, è ideale per allestire aree in spazi interni o esterni. S, M, L e XL sono le sue 4 misure, in modo da poterle posizionare come meglio si adatta al vostro spazio.



More about Nipori

DESIGNER
Stone Designs

YEAR
2023

LINE SKETCH

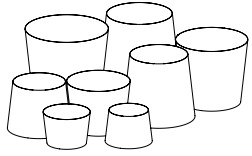

PRODUCT
* CONVEX



REFERENCE

NIP 01 / S

NIP 01 / M

NIP 01 / L

NIP 01 / XL

SIZE

Ø 43 x 30 cm
Ø 16,9 x 11,8 in

Ø 58 x 45 cm
Ø 22,8 x 17,7 in

Ø 66 x 60 cm
Ø 25,9 x 23,6 in

Ø 76 x 75 cm
Ø 29,9 x 29,5 in

PRODUCT
* CONCAVE



REFERENCE

NIP 02 / S

NIP 02 / M

NIP 02 / L

NIP 02 / XL

SIZE

Ø 36 x 30 cm
Ø 14,1 x 11,8 in

Ø 48 x 45 cm
Ø 18,8 x 17,7 in

Ø 53 x 60 cm
Ø 20,8 x 23,6 in

Ø 60 x 75 cm
Ø 23,6 x 29,5 in

DETAILS



METALLIC FINISHED
AVAILABLE SIZES

PLANTERS

LACQUERED COLOURS

- BL · Ral 9003
- CE · Ral 7033
- GR · Ral 7015
- AN · Ral 7016
- MA · Ral 8014
- OP · Ral 1036
- VF · Ral 6020
- VO · Ral 6011
- VD · Ral 6000
- PE · Ral 5020
- AZ · Ral 5009
- BD · Ral 3005
- RJ · Ral 3026
- RS · Ral 2012
- AM · Ral 1007
- NJ · Ral 2017

CUSTOMISE OPTIONS

- COLOUR

HUMAN PERCEPTION

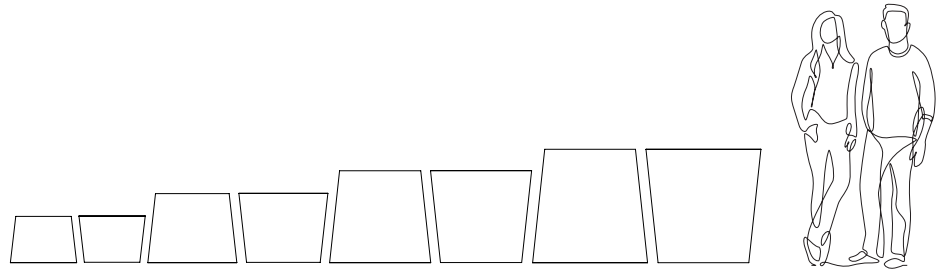

RANGE 16 COLORS

Kyoto

PLANTERS

by Joan Gaspar

An indoor planter that will enhance any interior with a self-watering system in case you forget to water the plants. Available in two sizes and five colours.

Una jardinera de interior que le dará frescura a tu espacio. Con un sistema de autorriego por si eres de los que se te olvida regar las plantas. Disponible en dos alturas y cinco colores.

Une jardinière d'intérieur qui donnera de la fraîcheur à votre espace. Avec un système d'auto-arrosage pour si vous êtes de ceux qui oublient d'arroser les plantes. Disponible en deux hauteurs et cinq couleurs.

Una fioriera da interni che darà freschezza al tuo spazio. Con un sistema di autoirrigazione nel caso tu fossi uno di quelli che ti dimentichi di annaffiare le piante. Disponibile in due altezze e cinque colori.



More about Kyoto

DESIGNER
Joan Gaspar

YEAR
2005

LINE SKETCH

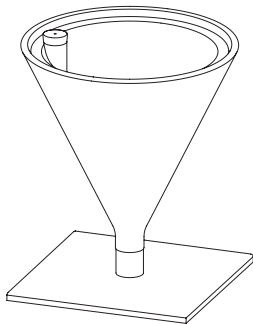

PRODUCT



REFERENCE
KYT 01

SIZE
Ø 39,6 x 44 cm
Ø 15,6 x 17,3 in

KYT 02

Ø 39,6 x 57 cm
Ø 15,6 x 22,4 in

DETAILS



BASES AND SIZE DETAIL

PLANTERS

COLOURS INJECTION

- BL · RAL 9003
- MO · RAL 1012
- TC · RAL 2001
- AN · RAL 7016
- NG · RAL 9011

HUMAN PERCEPTION

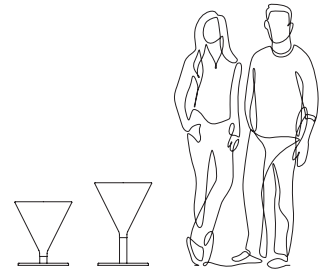

KYOTO SET



SELF WATERING SYSTEM

Designers



Ferran Guimerà

Niseko ¹⁰



Passionate about sports and fascinated by the world of design and innovation. For some years now, his curious and creative mind has led him to explore the aesthetics and functionality of everyday objects, where design is more than creating beautiful objects; it is telling a story through every detail, every choice of material and every aspect of the manufacturing process.

After finishing his studies in Industrial and Product Design in 2013, he started an adventure through Germany and Switzerland, where he was able to learn and carry out different design projects. Currently in Barcelona, he is focused on the world of contract and sports design.

Apasionado del deporte y fascinado por el mundo del diseño y la innovación. Desde hace unos años, su mente curiosa y creativa le ha llevado a explorar la estética y la funcionalidad de los objetos cotidianos, donde el diseño es más que la creación de objetos bonitos; es contar una historia a través de cada detalle, de cada elección de material y de cada aspecto del proceso de fabricación.

Después de acabar los estudios de Diseño industrial y producto en 2013, inició una aventura por Alemania y Suiza, donde pudo aprender y realizar distintos proyectos de diseño. Actualmente en Barcelona, está enfocado en el mundo del diseño contract y deportivo.

Gauzak

Naka ¹⁶



Gauzak is a product design studio established in 2011.

Its founding partners, Juan T. Carboneras and Leire Pérez, met during their industrial design studies at La Escola Massana (Barcelona).

Since then, they have developed its activity in different areas with projects for national and international clients, which led the studio to gain experience, knowledge and a mature cross sectional perspective of design and its client's needs.

Gauzak faces new challenges understanding design as a tool that must be open to people and companies. A creative and functional service focused on users, companies and their brands.

Somos un estudio de diseño de producto constituido en el año 2011. Sus socios fundadores somos, Juan T. Carboneras y Leire Pérez y nos conocimos durante nuestros estudios de diseño industrial en La Escola Massana (Barcelona).

Desde entonces hemos desarrollado nuestra actividad en diversos sectores con proyectos para clientes nacionales e internacionales, lo que nos ha permitido acumular experiencias y conocimientos y madurar una mirada transversal sobre las necesidades de diseño de cada uno de nuestros clientes.

Nos gusta afrontar nuevos retos entendiendo el diseño como un servicio que debe estar al alcance de personas y empresas: una herramienta creativa, funcional y focalizada sobre el usuario, las empresas y sus marcas.

Joan Gaspar

Kyoto ²⁴

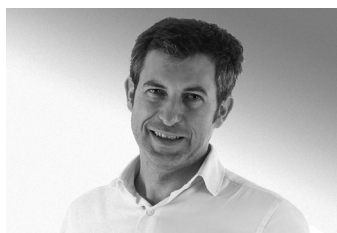

I began to learn the craft of designing under the guidance of Lluís Porqueras at the end of the 80s.

Today, I am a seasoned professional, but one who often thinks that his designs still retain the essence of those early years, given that I am still more interested in explaining how I have done things and showing how I have solved problems, rather than in the end result per se. That is not to say that the end result does not interest me, obviously it is very important, but, since the solution, about which everyone has their own opinion, is apparent, I feel that no one, other than its creator, can explain its hidden secrets knowledgeably and with passion.

Aprendí el oficio de diseñador industrial de la mano de Lluís Porqueras a finales de la década de los 80.

Hoy soy un profesional maduro, que normalmente piensa que sus trabajos aun mantienen el espíritu de aquellos primeros años, teniendo en cuenta que me sigue interesando más hablar de como he realizado las cosas y como las he resuelto que el resultado final; y no porque el resultado final no me interese, en realidad es realmente importante, sino porque el resultado final es obvio y hay que dejar que se juzgue, y los detalles invisibles solamente el autor los puede explicar con conocimiento y pasión.

Stone Designs

Zao ⁶

Nipori ²⁰



Stone Designs is the story of two people (Cutu Mazuelos 1973 and Eva Prego 1974), and their career spanning over twenty-years. During this time they have developed a huge variety of projects, from a personal perspective and without censure. This approach has allowed Stone Designs to give expression to its essence in every challenge faced. All this makes Stone Designs a dedicated studio, with a passion for design and for life.

Stone Designs responde a la historia de sus dos creadores (Cutu Mazuelos 1973 y Eva Prego 1974), y sus más de veinte años de carrera. Tiempo en el que ha desarrollado multitud de proyectos desde una perspectiva personal, sin censura ni filtros. Este modo de afrontar su trabajo ha hecho que durante todo este tiempo, Stone Designs haya sido capaz de plasmar su esencia en cada uno de los proyectos a los que se ha enfrentado. Stone Designs es ya un estudio consolidado pero no por ello menos entregado a su actividad, que es a la vez su pasión y razón de su existencia.

Technical Data

Contract

Zao	33
Niseko	34

Planters

Naka	35
Nipori	36
Kyoto	37

New Colour & finishes	38
-----------------------	----

Zao

by Stone Designs



← VIEW PRODUCT PAGES

6

CHARACTERISTICS

Bench made of steel tube Ø 50 mm and joined by welding. The planter module is made of steel. The seat module is made of wood, water resistant. And the cushion, with fabric for outdoors and easy to clean. Available in different combinations.

CARACTERÍSTICAS







Banco fabricado en tubo de acero de Ø 50 mm y unido mediante soldadura. El módulo jardinera está fabricada en acero. El módulo asiento está fabricado con madera, resistente al agua. Y el cojín, con tela para exterior y fácil de limpiar. Disponible en diversas combinaciones.

CARACTÉRISTIQUES

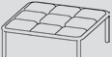
Banc fabriqué en tube d'acier de Ø 50 mm et soudé. Le module de plantation est en acier. Le module d'assise est en bois résistant à l'eau. Le coussin est en tissu d'extérieur, facile à nettoyer. Disponible en différentes combinaisons.

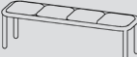
CARATTERISTICHE

Panchina realizzata in tubo d'acciaio Ø 50 mm e saldata tra loro. Il modulo della fioriera è in acciaio. Il modulo di seduta è in legno resistente all'acqua. Il cuscino è in tessuto per esterni, facile da pulire. Disponibile in varie combinazioni.

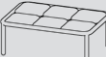







REF	↕↔	REF	↕↔
 ZAO 02 *STRUCTURE ONLY	85 x 47,5 x 45 cm 33,46 x 18,7 x 17,7 in 8,2 kg / 18 lb	 ZAO 09 *STRUCTURE ONLY	122,5 x 122,5 x 45 cm 48,2 x 48,2 x 17,7 in 18,9 kg / 41,6 lb
 ZAO 03 *STRUCTURE ONLY	122,5 x 47,5 x 45 cm 48,2 x 18,7 x 17,7 in 11,6 kg / 25,5 lb	 ZAO 15 *PLANTER 50 L / 13,2 G	37 x 37 x 45 cm 14,5 x 14,5 x 17,7 in 8 kg / 17,6 lb
 ZAO 04 *STRUCTURE ONLY	160 x 47,5 x 45 cm 63 x 18,7 x 17,7 in 15,5 kg / 34,1 lb	 ZAO 20 *TEXTIL	37 x 37 x 5 cm 14,5 x 14,5 x 1,9 in 1,8 kg / 4 lb
 ZAO 04C *STRUCTURE ONLY	85 x 85 x 45 cm 33,4 x 33,4 x 17,7 in 15,5 kg / 34,1 lb	 ZAO 25 *WOOD	37 x 37 x 3 cm 14,5 x 14,5 x 1,2 in 2,5 kg / 5,1 lb
 ZAO 06 *STRUCTURE ONLY	122,5 x 85 x 45 cm 48,2 x 33,4 x 17,7 in 17,2 kg / 37,9 lb		

*PARA CONFIGURAR EL PRODUCTO, DEBES ELEGIR LA ESTRUCTURA DESEADA Y LAS JARDINERAS O ASIENTOS (TEXTIL O MADERA) DE ACUERDO CON EL NÚMERO DE ESPACIOS DISPONIBLES EN LA ESTRUCTURA SELECCIONADA.
*TO CONFIGURE THE PRODUCT, YOU MUST CHOOSE THE DESIRED STRUCTURE AND THE PLANTERS OR SEATS (TEXTILE OR WOOD) ACCORDING TO THE NUMBER OF SPACES AVAILABLE IN THE SELECTED STRUCTURE.

LACQUERED COLOURS

 BL · Ral 9003	 VF · Ral 6020	 RJ · Ral 3026
 CE · Ral 7033	 VO · Ral 6011	 RS · Ral 2012
 GR · Ral 7015	 VD · Ral 6000	 AM · Ral 1007
 AN · Ral 7016	 PE · Ral 5020	 NJ · Ral 2017
 MA · Ral 8014	 AZ · Ral 5009	
 OP · Ral 1036	 BD · Ral 3005	

TEXTILE COLOURS

 VDC · FEROE 160	 RS · FEROE 90
 VDO · PATTAY 90	 RJ · PATTAY 60
 AZC · FEROE 190	 BD · CAPRI 150
 GR · FEROE 280	 AZO · MADEIRA 390

CUSTOMISE OPTIONS

 COLOUR

ENVIRONMENTAL IMPACT

Materials may be easily disassembled to be recycled.

Materiales fácilmente segregables para su posterior reciclado.

Matériaux facilement démontables pour leurs recyclages.

Materiali facilmente separabile per un successivo riciclaggio.

FIRE RESISTANCE

UNE-EN 13501-1

A1-s1, d0

WARRANTY

Two (2) year limited warranty. Does not cover: incorrect use, bad handling or deliberate damage.

GARANTIA

Garantía de dos (2) años limitada. No cubre: mal uso, manipulación o daños intencionados.

GARANTIE

Garantie deux (2) ans. À l'exception: mauvaise utilisation, manipulation, dommages intentionnés.

GARANZIA

Due (2) anni di garanzie limitati. Non copre: uso improprio, manipolazione o danno intenzionale.

PACKAGING

Cardboard box with plastic bag for product protection. One package.

EMBALAJE

Caja de cartón con bolsa de plástico para protección. Un paquete.

EMBALLAGE

Boîte en carton avec sac plastique pour la protection. Un paquet.

IMBALLAGGIO

Scatola di cartone con sacchetto di plastica per protezione. Un pacco.

Niseko

by Ferran Guimerà



← VIEW PRODUCT PAGES

10

CHARACTERISTICS

Trapezoidal module in 1.5 mm thick sheet metal, with two 2 mm rings welded to the body. They are placed, one at the bottom and one at the top, to fix the cushion modules and the covers. The cushion made of outdoor fabric is screwed to the module. The litter bin version has a lid and the planter version has a two-part lid.

CARACTERÍSTICAS



Módulo trapezoidal en chapa metálica de 1,5 mm de grosor, con dos aros de 2mm soldados al cuerpo. Se ubican, uno en la parte inferior y otro en la parte superior, para fijar los módulos del cojín y las tapas. El cojín fabricado de tejido para exterior se atornilla al módulo. La versión papelera dispone de tapa y la versión jardinera de tapa en dos partes.

CARACTÉRISTIQUES

Module trapézoïdal en tôle de 1,5 mm d'épaisseur, avec deux anneaux de 2 mm soudés au corps. Ils sont placés, l'un en bas et l'autre en haut, pour fixer les modules de coussins et les housses. Le coussin en tissu d'extérieur est vissé au module. La version poubelle est munie d'un couvercle et la version jardinière d'un couvercle en deux parties.

CARATTERISTICHE

Modulo trapezoidale in lamiera di 1,5 mm di spessore, con due anelli da 2 mm saldati al corpo. Vengono posizionati, uno in basso e uno in alto, per fissare i moduli dei cuscini e le coperture. Il cuscino in tessuto per esterni è avvitato al modulo. La versione cestino ha un coperchio, mentre la versione fioriera ha un coperchio in due parti.









	REF	↕↔		REF	↕↔
	NSK 10	56 x 35 x 40 cm / 22 x 13,7 x 15,7 in 10,2 kg / 22,4 lb		NSK 40	49 x 43 x 66 cm / 19,3 x 17 x 26 in 7,5 kg / 16,5 lb
	NSK 15 *TEXTIL	56 x 35 x 10 cm / 22 x 13,7 x 3,9 in 2,2 kg / 4,8 lb			
	NSK 20 *PLANTER	56 x 35 x 40 cm / 22 x 13,7 x 15,7 in 13,1 kg / 28,8 lb			
	NSK 30 *TRASH	56 x 35 x 40 cm / 22 x 13,7 x 15,7 in 13,1 kg / 28,8 lb			

*EL MÓDULO NISEKO NSK 10 DEBE COMPLEMENTARSE NECESARIAMENTE CON LA REFERENCIA NSK 15, Y EN AMBOS CASOS, SE DEBE SELECCIONAR EL COLOR DESEADO.
*THE NISEKO NSK 10 MODULE MUST NECESSARILY BE COMPLEMENTED WITH REFERENCE NSK 15, AND IN BOTH CASES, THE DESIRED COLOR SHOULD BE CHOSEN.



LACQUERED COLOURS

 BL · Ral 9003	 VF · Ral 6020	 RJ · Ral 3026
 CE · Ral 7033	 VO · Ral 6011	 RS · Ral 2012
 GR · Ral 7015	 VD · Ral 6000	 AM · Ral 1007
 AN · Ral 7016	 PE · Ral 5020	 NJ · Ral 2017
 MA · Ral 8014	 AZ · Ral 5009	
 OP · Ral 1036	 BD · Ral 3005	

TEXTILE COLOURS

 VDC · FEROE 160	 RS · FEROE 90
 VDO · PATTAY 90	 RJ · PATTAY 60
 AZC · FEROE 190	 BD · CAPRI 150
 GR · FEROE 280	 AZO · MADEIRA 390

CUSTOMISE OPTIONS

-  COLOUR
-  PICTOGRAMS

ENVIRONMENTAL IMPACT

Materials may be easily disassembled to be recycled.

Materiales fácilmente segregables para su posterior reciclado.

Matériaux facilement démontables pour leurs recyclages.

Materiali facilmente separabile per un successivo riciclaggio.

FIRE RESISTANCE

UNE-EN 13501-1

A1-s1, d0

WARRANTY

Two (2) year limited warranty. Does not cover: incorrect use, bad handling or deliberate damage.

GARANZIA

Garantía de dos (2) años limitada. No cubre: mal uso, manipulación o daños intencionados.

GARANTIE

Garantie deux (2) ans. À l'exception: mauvaise utilisation, manipulation, dommages intentionnés.

GARANZIA

Due (2) anni di garanzie limitati. Non copre: uso improprio, manipolazione o danno intenzionale.

PACKAGING

Cardboard box with plastic bag for product protection. One package.

EMBALAJE

Caja de cartón con bolsa de plástico para protección. Un paquete.

EMBALLAGE

Boîte en carton avec sac plastique pour la protection. Un paquet.

IMBALLAGGIO

Scatola di cartone con sacchetto di plastica per protezione. Un pacco.

Naka

by Gauzak



← VIEW PRODUCT PAGES

16

CHARACTERISTICS

Planter made of 1.5 mm thick sheet iron, available in two heights of 40 and 80 cm. It has three different models of leaves, screwed to a 4 mm thick handrail, where their position can be randomly combined. The top cover is removable for cleaning. The planter is also available for natural plants.

CARACTERÍSTICAS



Jardinería fabricada en chapa de hierro de 1,5 mm de grosor, disponible en dos alturas de 40 y 80 cm. Dispone de tres modelos distintos de hojas, atornilladas a un pasamano de 4 mm de grosor, donde se pueden combinar su posición aleatoriamente. La tapa superior es extraíble para limpiar. La jardinería también se encuentra disponible para planta natural.



CARACTÉRISTIQUES

Jardinière en tôle de fer de 1,5 mm d'épaisseur, disponible en deux hauteurs, 40 et 80 cm. Elle possède trois modèles différents de feuilles, vissées à une main courante de 4 mm d'épaisseur, dont la position peut être combinée de manière aléatoire. Le couvercle est amovible pour le nettoyage. La jardinière est également disponible pour les plantes naturelles.

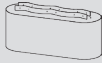
CARATTERISTICHE

Fioriera in lamiera di ferro di 1,5 mm di spessore, disponibile in due altezze di 40 e 80 cm. È dotata di tre diversi modelli di foglie, avvitate a un corrimano di 4 mm di spessore, la cui posizione può essere combinata in modo casuale. Il coperchio superiore è rimovibile per la pulizia. La fioriera è disponibile anche per piante naturali.

REF	↕↔
 NAK 01 *FOR METALLIC OR PET LEAVES	102 x 35 x 40 cm / 40,1 x 13,7 x 15,7 in 25,4 kg / 55,99 lb
 NAK 02 *FOR METALLIC OR PET LEAVES	102 x 35 x 80 cm / 40,1 x 13,7 x 31,4 in 38,8 kg / 85,53 lb
 NAK 05 *FOR PLANTS	102 x 35 x 40 cm / 40,1 x 13,7 x 15,7 in 20,75 kg / 45,74 lb
 NAK 07 *FOR PLANTS	102 x 35 x 80 cm / 40,1 x 13,7 x 31,4 in 34,15 kg / 75,28 lb

REF	↕↔
 NAK 10 *METAL NAK 20 *PET	66 x 38 cm / 25,9 x 14,9 in 2,1 kg / 4,6 lb (*METAL) 0,320 kg / 0,7 lb (*PET)
 NAK 11 *METAL NAK 21 *PET	101 x 34 cm / 39,7 x 13,3 in 3,2 kg / 7 lb (*METAL) 0,480 kg / 1,05 lb (*PET)
 NAK 12 *METAL NAK 22 *PET	77 x 55,5 cm / 30,3 x 21,8 in 3,1 kg / 6,8 lb (*METAL) 0,450 kg / 0,99 lb (*PET)

LACQUERED COLOURS

BL · Ral 9003	VF · Ral 6020	RJ · Ral 3026
CE · Ral 7033	VO · Ral 6011	RS · Ral 2012
GR · Ral 7015	VD · Ral 6000	AM · Ral 1007
AN · Ral 7016	PE · Ral 5020	NJ · Ral 2017
MA · Ral 8014	AZ · Ral 5009	
OP · Ral 1036	BD · Ral 3005	

PET COLOURS

BO - 00	BE - 32	R0 - 60
GM - 08	AZ - 05	RS - 31
GM - 92	AZ - 25	RS - 67
GS - 96	AM - 90	VR - 07
NO - 00	IL - 18	VR - 11
BE - 02	NR - 09	VR - 25

CUSTOMISE OPTIONS

- COLOUR
- PICTOGRAMS

ENVIRONMENTAL IMPACT

Materials may be easily disassembled to be recycled.	Materiales fácilmente segregables para su posterior reciclado.	Matériaux facilement démontables pour leurs recyclages.	Materiali facilmente separabile per un successivo riciclaggio.
--	--	---	--

FIRE RESISTANCE

UNE-EN 13501-1	A1-s1, d0
----------------	-----------

WARRANTY

Two (2) year limited warranty. Does not cover: incorrect use, bad handling or deliberate damage.

GARANTIA

Garantía de dos (2) años limitada. No cubre: mal uso, manipulación o daños intencionados.

GARANTIE

Garantie deux (2) ans. À l'exception: mauvaise utilisation, dommages intentionnés.

GARANZIA

Due (2) anni di garanzie limitati. Non copre: uso improprio, manipolazione o danno intenzionale.

PACKAGING

Cardboard box with plastic bag for product protection. One package.

EMBALAJE

Caja de cartón con bolsa de plástico para protección. Un paquete.

EMBALLAGE

Boîte en carton avec sac plastique pour la protection. Un paquet.

IMBALLAGGIO

Scatola di cartone con sacchetto di plastica per protezione. Un pacco.

Nipori

by Stone Desigs



← VIEW PRODUCT PAGES

20

CHARACTERISTICS

Concave and convex planters made of 1.5 mm thick sheet metal in different heights and diameters with a micro-textured lacquered finish.

CARACTERÍSTICAS









Jardineras cóncava y convexa de chapa metálica de 1,5 mm de grosor en diferentes alturas y diámetros con un acabado lacado microtexturizado.

CARACTÉRISTIQUES

Jardinières concaves et convexes en tôle d'acier de 1,5 mm d'épaisseur, de différentes hauteurs et de différents diamètres, avec une finition laquée microtexturée.

CARATTERISTICHE

Fioriere concave e convesse in lamiera di 1,5 mm di spessore, in diverse altezze e diametri, con finitura laccata microtesturizzata.

REF	↕↔	REF	↕↔		
* CONVEX		* CONCAVE			
	NIP 01 / S	Ø 43 x 30 cm / Ø 16,9 x 11,8 in 6,1 kg / 13,4 lb		NIP 02 / S	Ø 36 x 30 cm / Ø 14,1 x 11,8 in 7 kg / 15,4 lb
	NIP 01 / M	Ø 58 x 45 cm / Ø 22,8 x 17,7 in 11,8 kg / 26 lb		NIP 02 / M	Ø 48 x 45 cm / Ø 18,8 x 17,7 in 13,2 kg / 29,1 lb
	NIP 01 / L	Ø 66 x 60 cm / Ø 25,9 x 23,6 in 16,7 kg / 36,8 lb		NIP 02 / L	Ø 53 x 60 cm / Ø 20,8 x 23,6 in 18,3 kg / 40,3 lb
	NIP 01 / XL	Ø 76 x 75 cm / Ø 29,9 x 29,5 in 23,4 kg / 51,5 lb		NIP 02 / XL	Ø 60 x 75 cm / Ø 23,6 x 29,5 in 25,9 kg / 57 lb

LACQUERED COLOURS

 BL · Ral 9003	 VD · Ral 6000	 VF · Ral 6020	 RJ · Ral 3026
 CE · Ral 7033	 PE · Ral 5020	 VO · Ral 6011	 RS · Ral 2012
 GR · Ral 7015	 AZ · Ral 5009	 MA · Ral 8014	 AM · Ral 1007
 AN · Ral 7016	 BD · Ral 3005	 OP · Ral 1036	 NJ · Ral 2017

CUSTOMISE OPTIONS

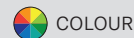

ENVIRONMENTAL IMPACT

Materials may be easily disassembled to be recycled.

Materiales fácilmente segregables para su posterior reciclado.

Matériaux facilement démontables pour leurs recyclages.

Materiali facilmente separabile per un successivo riciclaggio.

FIRE RESISTANCE

UNE-EN 13501-1

A1-s1, d0

WARRANTY

Two (2) year limited warranty. Does not cover: incorrect use, bad handling or deliberate damage.

GARANTIA

Garantía de dos (2) años limitada. No cubre: mal uso, manipulación o daños intencionados.

GARANTIE

Garantie deux (2) ans. À l'exception: mauvaise utilisation, manipulation, dommages intentionnés.

GARANZIA

Due (2) anni di garanzie limitati. Non copre: uso improprio, manipolazione o danno intenzionale.

PACKAGING

Cardboard box with plastic bag for product protection. One package.

EMBALAJE

Caja de cartón con bolsa de plástico para protección. Un paquete.

EMBALLAGE

Boîte en carton avec sac plastique pour la protection. Un paquet.

IMBALLAGGIO

Scatola di cartone con sacchetto di plastica per protezione. Un pacco.

Kyoto

by Joan Gaspar



← VIEW PRODUCT PAGES

24

CHARACTERISTICS

Polyethylene planter made with roto-moulding. Stainless steel post and base. Interior of planter holds water and functions as a water tank. Regulation of the water passage by means of a ceramic piece at the base. Tank cap in anodized aluminium. Base with rubber studs to protect the surface where it is located.

CARACTERÍSTICAS

Jardinera de polietileno fabricada por roto-moldeo. Base y tubo de acero inoxidable. Interior de la jardinera vacío, que hace la función de depósito de agua. Regulación del paso de agua mediante una pieza cerámica en la base. Tapón del depósito en aluminio anodizado. Base con tacos de goma para proteger la superficie donde se ubique.

CARACTÉRISTIQUES

Jardinière en polyéthylène fabriquée par rotomoulage. Base et tube en acier inoxydable. Intérieur de la jardinière vide, qui sert de réservoir d'eau. Régulation du passage de l'eau au travers d'une pièce en céramique dans la base. Bouchon de réservoir en aluminium anodisé. Base avec des gommages de caoutchouc pour protéger la surface où elle se trouve.

CARATTERISTICHE

Fioriera in polietilene prodotta mediante rotostampaggio. Base e tubo in acciaio inox. L'interno della fioriera è vuoto, che funge da serbatoio dell'acqua. Regolazione del flusso d'acqua attraverso un pezzo in ceramica alla base. Tappo serbatoio in alluminio anodizzato. Base con borchie in gomma per proteggere la superficie dove si trova.

REF



KYT 01

Ø 39,6 x 44 cm / Ø 15,6 x 17,3 in
5 kg / 11 lb



KYT 02

Ø 39,6 x 57 cm / Ø 15,6 x 22,4 in
5,8 kg / 12,8 lb

COLOURS INJECTION

BL · RAL 9003 AN · RAL 7016

MO · RAL 1012 NG · RAL 9011

TC · RAL 2001

ENVIRONMENTAL IMPACT

Materials may be easily disassembled to be recycled.

Materiales fácilmente segregables para su posterior reciclado.

Matériaux facilement démontables pour leurs recyclages.

Materiali facilmente separabile per un successivo riciclaggio.

FIRE RESISTANCE

UNE-EN 13501-1

B-s1, d1

WARRANTY

Two (2) year limited warranty. Does not cover: incorrect use, bad handling or deliberate damage.

GARANTIA

Garantía de dos (2) años limitada. No cubre: mal uso, manipulación o daños intencionados.

GARANTIE

Garantie deux (2) ans. À l'exception: mauvaise utilisation, manipulation, dommages intentionnés.

GARANZIA

Due (2) anni di garanzie limitati. Non copre: uso improprio, manipolazione o danno intenzionale.

PACKAGING

Cardboard box with plastic bag for product protection. One package.

EMBALAJE

Caja de cartón con bolsa de plástico para protección. Un paquete.

EMBALLAGE









Boîte en carton avec sac plastique pour la protection. Un paquet.

IMBALLAGGIO





Scatola di cartone con sacchetto di plastica per protezione. Un pacco.

Colours & finishes

NEW LACQUERED COLOURS

 BL · RAL 9003	 VF · RAL 6020	 RJ · RAL 3026
 CE · RAL 7033	 VO · RAL 6011	 RS · RAL 2012
 GR · RAL 7015	 VD · RAL 6000	 AM · RAL 1007
 AN · RAL 7016	 PE · RAL 5020	 NJ · RAL 2017
 MA · RAL 8014	 AZ · RAL 5009	
 OP · RAL 1036	 BD · RAL 3005	

COLOURS INJECTION

 BL · RAL 9003	 MO · RAL 1012	 TC · RAL 2001
 AN · RAL 7016	 NG · RAL 9011	

PET COLOURS

 BO · 00	 BE · 32	 RO · 60
 GM · 08	 AZ · 05	 RS · 31
 GM · 92	 AZ · 25	 RS · 67
 GS · 96	 AM · 90	 VR · 07
 NO · 00	 IL · 18	 VR · 11
 BE · 02	 NR · 09	 VR · 25

TEXTILE COLOURS

 VDC · FEROE 160	 AZO · MADEIRA 390	 BD · CAPRI 150
 VDO · PATTAY 90	 RS · FEROE 90	 GR · FEROE 280
 AZC · FEROE 190	 RJ · PATTAY 60	

CUSTOMISE OPTIONS



Headquarters

Polígono Industrial Pla d'en Coll
Camí de la Font Freda 17, Nave 4
08110 Montcada i Reixac
Barcelona, Spain

T. +34 935 616 595

info@madedesign.es
www.madedesign.es

follow us
[@made_design](#)

AENOR **AENOR**

GESTIÓN
DE LA CALIDAD

ISO 9001

ER-0209/2021

GESTIÓN
AMBIENTAL

ISO 14001

GA-2021/0082