

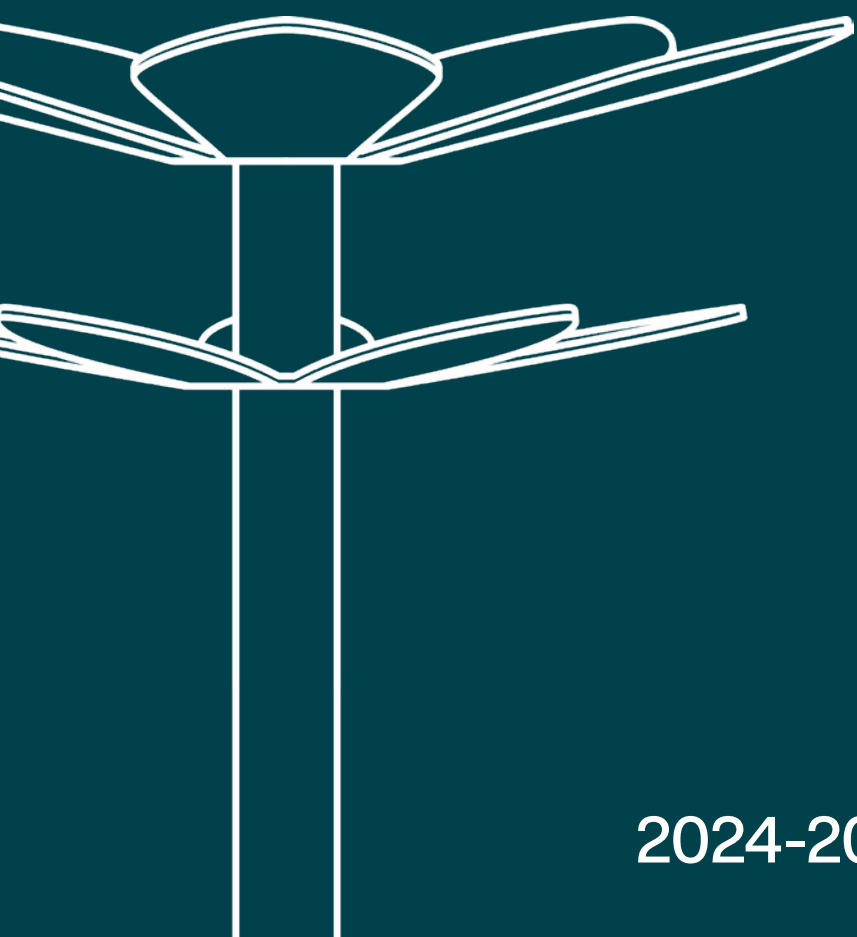

 **Planning
Sisplamo**

making *details* exceptional



2024-2025

About Us

Writeboards / Pizarras

Pinboards / Tablón de Anuncios

Partitions / Separadores

Acoustic / Acústico

Display / Portacarteles y Expositores

Contract

Annex

4

12

86

118

142

166

180

220



Fabricamos accesorios para la oficina, la educación, el hogar y el contract.

Nuestras colecciones de productos se crean en nuestras instalaciones de Barcelona después de un cuidadoso proceso de selección de materiales y acabados, en los que primamos la sostenibilidad como eje principal en todos los proyectos. Conseguir productos estéticos, funcionales y sostenibles es nuestro cometido desde nuestros inicios en 1967. Tras más de 50 años, y operando en más de 60 países, seguimos teniendo en nuestro ADN una convicción de crear productos estéticos, funcionales y longevos.

We manufacture accessories for the office, education, home and contract.

Our product collections are created at our facilities in Barcelona after a careful selection process of materials and finishes in which we prioritize sustainability as the main axis in all projects. Achieving aesthetic, functional and sustainable products has been our mission since our inception in 1967. After more than 50 years, and operating in more than 60 countries, we continue to have within our DNA a conviction to create aesthetic, functional and long-lasting products.

Nous fabriquons des accessoires pour le bureau, l'éducation, la maison et le contract.

Nos collections de produits sont créées dans nos installations de Barcelone après un processus minutieux de sélection des matériaux et des finitions, dans lequel nous privilégions la durabilité comme axe principal de tous nos projets. La réalisation de produits esthétiques, fonctionnels et durables est notre mission depuis nos débuts en 1967. Après plus de 50 ans, et opérant dans plus de 60 pays, nous avons toujours dans notre ADN la conviction de créer des produits esthétiques, fonctionnels et durables.

Fabbrichiamo accessori per l'ufficio, l'istruzione, la casa e il contract.

Le nostre collezioni di prodotti sono create nei nostri stabilimenti di Barcellona dopo un attento processo di selezione di materiali e finiture, in cui diamo priorità alla sostenibilità come obiettivo principale in tutti i progetti. Realizzare prodotti estetici, funzionali e sostenibili è stata la nostra missione fin dagli inizi, nel 1967. Dopo più di 50 anni, e dopo aver operato in più di 60 Paesi, abbiamo ancora nel nostro DNA la convinzione di creare prodotti estetici, funzionali e duraturi.

Fabricamos una amplia gama de productos, capaces de cubrir el mayor número de necesidades que demanden nuestros clientes, y si requieren algo que no tenemos, lo diseñamos y lo fabricamos. Conscientes de que la personalización forma parte de una necesidad intrínseca, debido a la diversidad cultural de cada compañía, nosotros adaptamos nuestros productos pudiéndolos personalizar en cuanto a medidas, acabados, materiales y colores.

Standard o a medida, podemos hacerlo.

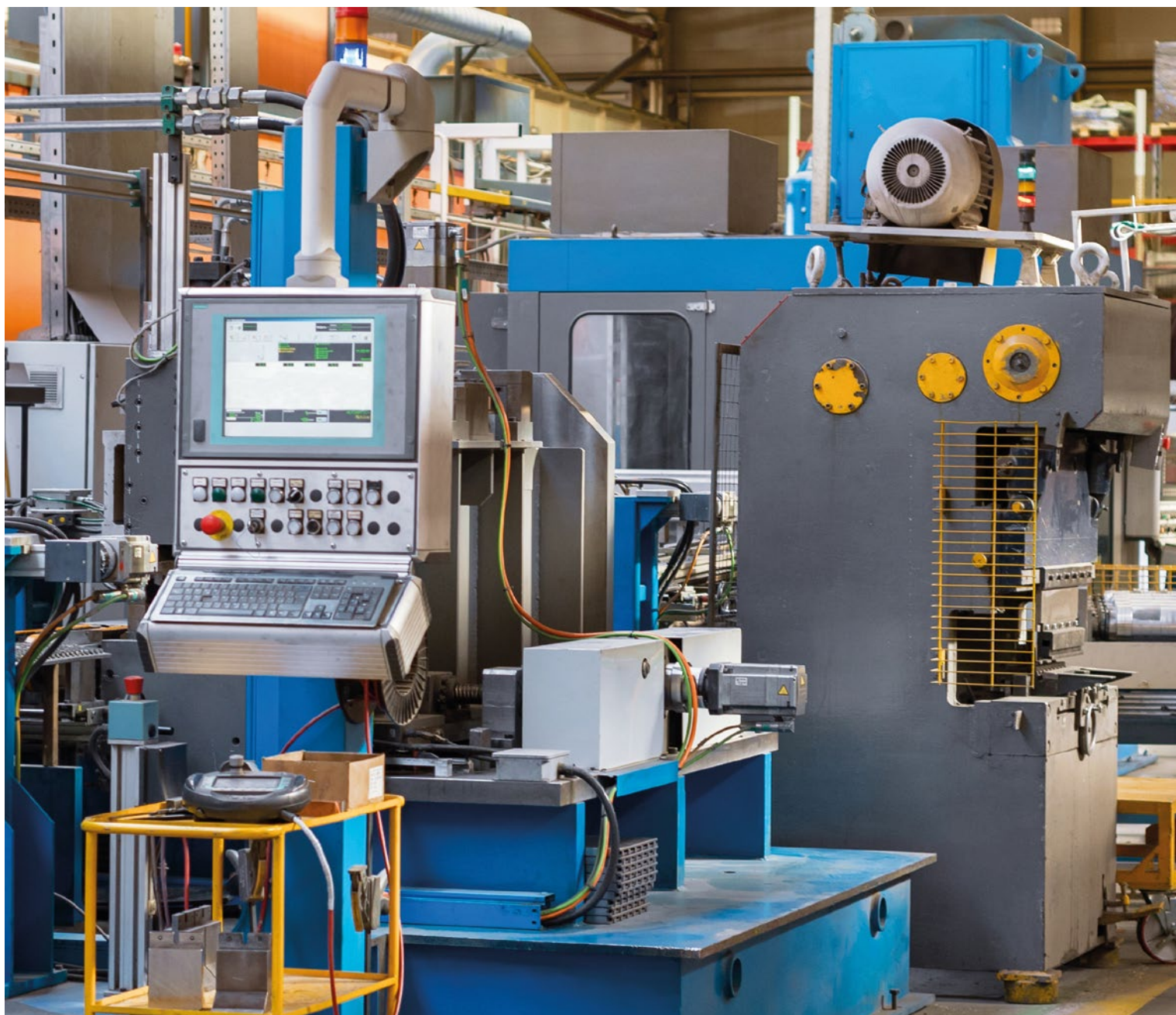



We manufacture a wide range of products, responding to client requests. We can design and manufacture it. Aware that customization is part of an intrinsic need, due to the cultural diversity of each company, we adapt our products and can customize them in terms of size, finishes, materials and colours.

Standard or specials, we can do it.

Nous fabriquons une large gamme de produits, capables de couvrir un très grand nombre des demandes de nos clients, si vous avez besoin d'un produit que nous n'avons pas, nous le concevons et le fabriquons pour vous. Conscients que la personnalisation fait partie d'un besoin intrinsèque, en raison de la diversité culturelle de chaque entreprise, nous adaptons nos produits et pouvons les personnaliser en termes de tailles, de finitions, de matériaux et de couleurs.

Standard ou sur mesure, nous pouvons le faire.

Realizziamo un'ampia gamma di prodotti, in grado di coprire il maggior numero di esigenze che i nostri clienti richiedono e, se hanno bisogno di qualcosa che non abbiamo, lo progettiamo e lo produciamo. Consapevoli che la personalizzazione è un'esigenza intrinseca, dovuta alla diversità culturale di ogni azienda, adattiamo i nostri prodotti e possiamo personalizzarli in termini di misure, finiture, materiali e colori.

Standard o su misura, possiamo farlo.

Demostramos nuestro compromiso en reducir la huella ecológica asegurando una larga vida útil de nuestros productos.

Generamos una relación de confianza con proveedores de km 0, practicamos la economía circular como fundamento base de nuestra empresa, optimizando la producción de nuestras colecciones desde el diseño inicial hasta la instalación en el proyecto. Tratamos con responsabilidad los procesos, los materiales, el uso de la energía, agua y gestión de residuos para reducir los impactos negativos en el planeta. Pensando en un mejor futuro para todos.

We demonstrate our commitment to reducing our ecological footprint by ensuring the long life of our products.

We build a relationship of trust with zero KM suppliers, we practice the circular economy as the foundation of our company, optimising starting with the initial production and design through to installation of the project. We treat processes, materials, energy use, water and waste management responsibly to reduce negative impacts on the planet. Thinking about a better future for everyone.

Nous démontrons notre engagement à réduire notre empreinte écologique en assurant une longue durée de vie pour nos produits.

Nous générons une relation de confiance avec les fournisseurs de km 0, nous pratiquons l'économie circulaire comme fondement de notre entreprise, en optimisant la production de nos collections de la conception initiale à l'installation dans le projet. Nous traitons avec responsabilité les processus, les matériaux, l'utilisation de l'énergie, l'eau et la gestion des déchets afin de réduire les impacts négatifs sur la planète. Pensant en un meilleur avenir pour tous.

Dimostriamo il nostro impegno a ridurre l'impronta ecologica garantendo la longevità dei nostri prodotti.

Costruiamo un rapporto di fiducia con i fornitori a km 0, pratichiamo l'economia circolare come fondamento della nostra attività, ottimizzando la produzione delle nostre collezioni dalla progettazione iniziale all'installazione del progetto. Trattiamo in modo responsabile i processi, i materiali, l'uso dell'energia, l'acqua e la gestione dei rifiuti per ridurre gli impatti negativi sul pianeta. Pensando a un futuro migliore per tutti.

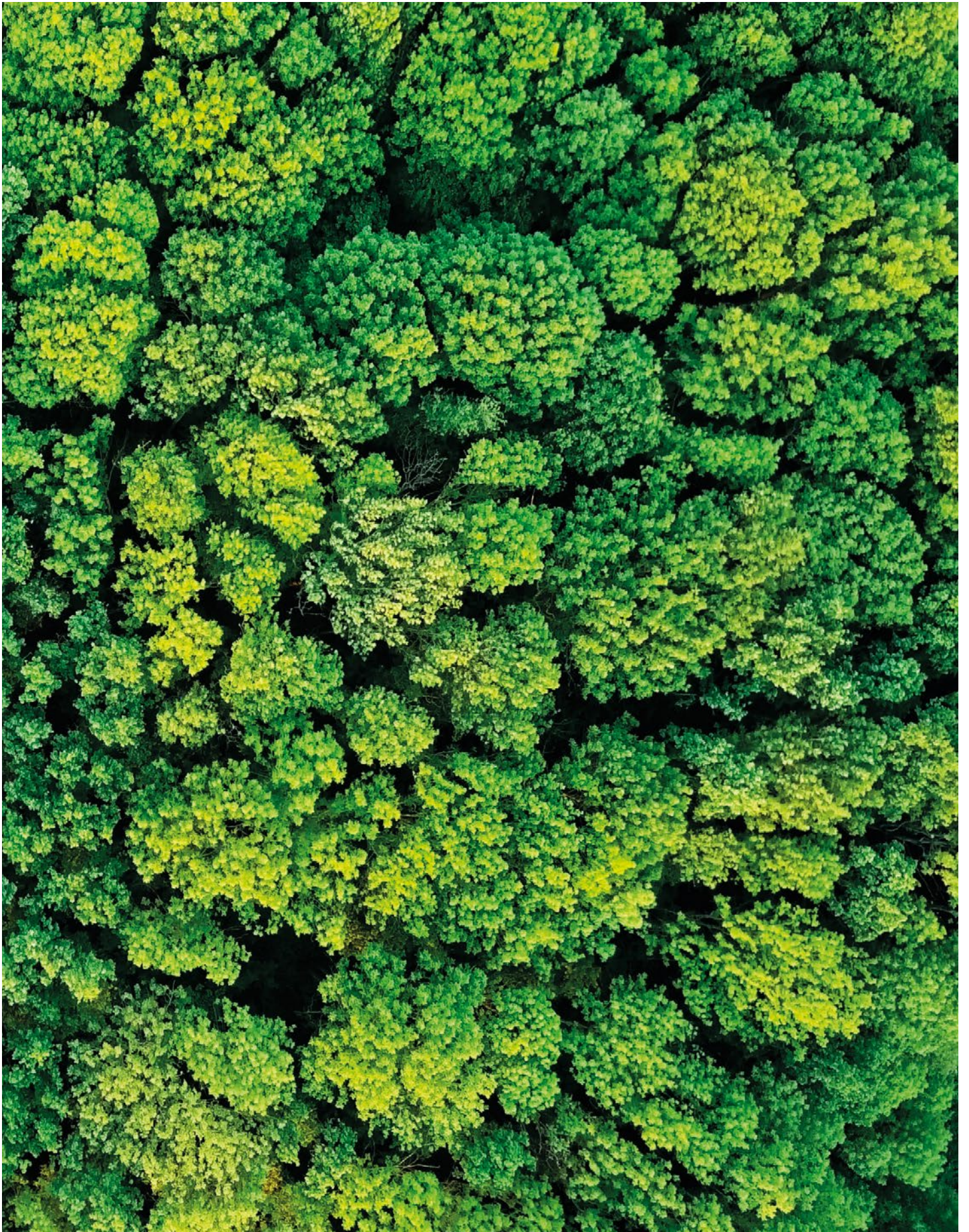

Y lo más importante... en el 2025 más del 50% de la fuerza laboral serán millennials... y es en ellos en quien pensamos y para los que creamos nuestros nuevos productos. Estéticos, frescos y dinámicos... pero funcionales y duraderos. Queremos ser parte de su día a día, cumplir sus exigencias y que nos ayuden a mejorar los entornos de trabajo.

Su felicidad es lo que nos mueve.





And most importantly ... by 2025 more than 50% of the workforce will be millennials ... and it is them that we think of and for whom we create our new products. Aesthetic, fresh and dynamic... but functional and durable. We want to be part of their day to day, meet their demands and help us to improve work environments.

Your happiness is what moves us.

Et le plus important... d'ici 2025, plus de 50% des effectifs seront des milléniaux ... et c'est à eux que nous pensons et pour qui nous créons nos nouveaux produits. Esthétiques, frais et dynamiques... mais aussi fonctionnels et durables. Nous voulons faire partie de leur quotidien, répondre à leurs demandes et qu'ils nous aident à améliorer nos environnements de travail.

Votre bonheur c'est ce qui nous motive.

E la cosa più importante... nel 2025 più del 50% della forza lavoro sarà costituita da millennial... e noi pensiamo e creiamo i nostri nuovi prodotti pensando a loro. Estetici, freschi e dinamici... ma funzionali e durevoli. Vogliamo far parte della loro vita quotidiana, soddisfare le loro esigenze e contribuire a migliorare i loro ambienti di lavoro.

È la vostra felicità a guidarci.

Whiteboards

Slim Board - Pizarra	14
Classic Magnetic Board - Pizarra Magnética Clásica	20
Classic Board - Pizarra Clásica	24
R·Pet Board - Pizarra con cantoneras / perfil Reciclados	28
Rail Plan - Pizarra de Raíl	32
Zenit Board - Pizarra Zenit	36
Diptic & Triptic Boards - Pizarra Díptica y Tríptica	40
Rotating Board - Pizarra Volteable	44
Vaiven Board - Pizarras de Vaivén	48
Guillotine Board - Pizarras de Guillotina	50
Basic Board - Pizarra Basic	52
Chameleon General - Chameleon General	54
Chameleon Custom - Chameleon Personalizable	56
Chameleon Wall - Chameleon Mural	58
Chameleon Sharp - Chameleon canto Recto	60
Chameleon Curve - Chameleon canto Curvo	62
Chameleon Print - Chameleon Imprimible	64
Glass Board - Pizarra de Cristal	66
Coloured Glass Board - Pizarra de Cristal coloreada	68
Chameleon Glass Board - Chameleon de Cristal Magnético	72
Flipcharts - Pizarra de Caballete	76
Screen Board - Mampara separadora de pizarra	78
Supports - Soportes	80
Accessories - Accesorios	84

Escribir nos permite comprender, procesar, pensar, de ahí que en todos los procesos de aprendizaje, ya sea en la escuela, la universidad o en la empresa, la pizarra ha sido, es y será una herramienta indispensable. Eso sí, dejamos a tu elección el tipo de pizarra que más te guste o mejor se adapte a tu espacio. El acto de escribir a mano estimula áreas del cerebro que también se activan cuando reflexionamos. Escribir a mano es un acto físico, como físicas son nuestras pizarras y al igual que la escritura dice mucho del carácter de la persona que escribe, las pizarras dicen mucho del carácter de sus empresas.

Writing allows us to understand, process, think, hence in all learning processes, whether at school, university or at work, the blackboard has been, is and will be an indispensable tool. Of course, we leave it up to you the type of drawing board that you like the most or best suits your needs. The act of handwriting stimulates areas of the brain that are also activated when we reflect. Writing by hand is a physical act, as our blackboards are physical, and just as writing says a lot about the character of the person whose writing, blackboards say a lot about the character of their companies.

L'écriture permet de comprendre, traiter, penser, dans tous les processus d'apprentissage, que ce soit à l'école, à l'université ou en entreprise, le tableau a été, et sera toujours un outil indispensable. Bien entendu, nous vous laissons le choix du type de tableaux que vous aimez le plus ou qui convient le mieux à votre espace. L'acte d'écrire à la main stimule des zones du cerveau qui s'activent lorsque nous réfléchissons. Ecrire à la main est un acte physique, aussi physique que sont nos tableaux, et tout comme l'écriture en dit long sur le caractère de la personne qui écrit, les tableaux en disent long sur le caractère de leur entreprise.

La scrittura ci permette di capire, elaborare, pensare, quindi in tutti i processi di apprendimento, a scuola, all'università o sul posto di lavoro, la lavagna è stata, è e sarà uno strumento indispensabile. Tuttavia, lasciamo a voi la scelta del tipo di lavagna che più vi piace o che meglio si adatta al vostro spazio. L'atto di scrivere a mano stimola aree del cervello che si attivano anche quando riflettiamo. Scrivere a mano è un atto fisico, così come sono fisiche le nostre lavagne, e così come la scrittura dice molto del carattere di chi scrive, le lavagne dicono molto del carattere delle loro aziende.



Slim board



Pizarra mural blanca o verde, fabricada en acero vitrificado de alta calidad para escritura con rotuladores de borrado en seco o tiza. Enmarcada con perfil de aluminio Slim disponible en 2 acabados (aluminio y madera), la de aluminio en plata mate, antracita y blanco. Superficie magnética apta para imanes. Incluye cajetín reposa rotuladores de 30 cm.

White or green drawing board, made from high quality vitrified steel for writing with dry erase markers or chalk. Framed with Slim aluminium profile available in 2 finishes (aluminium and wood), aluminium in matt silver, anthracite and white. Magnetic surface suitable for magnets. Includes 30 cm marker box.

Tableau mural blanc ou vert, fabriqué en acier émaillé de haute qualité pour marqueurs effaçables à sec ou craie. Encadré avec un profil en aluminium Slim disponible en 2 finitions (aluminium et bois), aluminium en argent mate, anthracite et blanc. Surface magnétique adaptée aux aimants. Comprend un auget pour marqueurs de 30 cm.

Lavagna da disegno bianca o verde, realizzata in acciaio vetrificato di alta qualità per scrivere con pennarelli cancellabili a secco o gessetti. Cornice con profilo in alluminio Slim disponibile in 2 finiture (alluminio e legno), alluminio in argento opaco, antracite e bianco. Superficie magnetica adatta ai magneti. Include una scatola per pennarelli da 30 cm.

Medidas / Sizes

PARA PIZARRA BLANCA / FOR WHITEBOARD

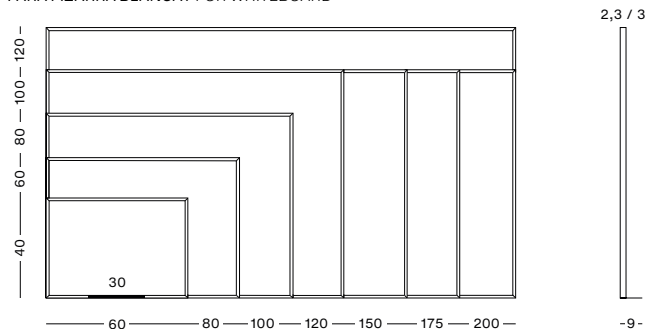

PARA PIZARRA DE TIZA / FOR CHALKBOARD

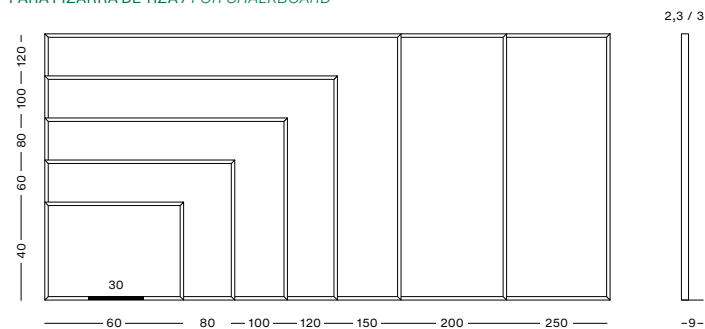

Especificaciones / Specifications

PARA PIZARRA BLANCA / FOR WHITEBOARD



PARA PIZARRA DE TIZA / FOR CHALKBOARD



Slim board

Marcos de madera / Wood frames



PARED / WALL

 PIZARRA BLANCA / WHITEBOARD

AV



REF	↕ ↔	📏
724/10/WO	40x60 cm 15.7x23.6 in	2,4 Kg 5.2 Lb
724/1/WO	60x80 cm 23.6x31.5 in	4.8 Kg 10.5 Lb
724/2/WO	80x100 cm 31.5x39.3 in	8 Kg 17.6 Lb
724/3/WO	100x120 cm 39.3x47.2 in	12 Kg 26.4 Lb
724/4/WO	100x150 cm 39.3x60 in	15 Kg 33 Lb
724/5/WO	100x175 cm 39.3x70 in	17.5 Kg 38.5 Lb
724/6/WO	120x200 cm 47.2x78.7 in	24Kg 52.9 Lb

 PIZARRA DE TIZA / CHALKBOARD

AV

→ ←

REF	↕ ↔	📏	3 cm 1.18 in
734/10/WO	40x60 cm 15.7x23.6 in	2,4 Kg 5.2 Lb	
734/1/WO	60x80 cm 23.6x31.5 in	4.8 Kg 10.5 Lb	
734/2/WO	80x100 cm 31.5x39.3 in	8 Kg 17.6 Lb	
734/3/WO	100x120 cm 39.3x47.2 in	12 Kg 26.4 Lb	
734/4/WO	120x150 cm 47.2x60 in	15 Kg 33 Lb	
734/5/WO	120x200 cm 47.2x78.7 in	24Kg 52.9 Lb	

SOPORTE DE MADERA / WOOD SUPPORT

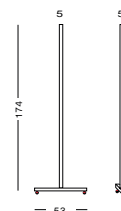

SOPORTE / SUPPORT

 PIZARRA BLANCA / WHITEBOARD

 PIZARRA DE TIZA / CHALKBOARD

→ ←

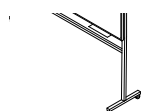

REF*	↕ ↔	↕
770/1/WO/1	80x100 cm 31.5x39.3 in	174 cm 68.5 in
770/1/WO/2	100x120 cm 39.4x47.2 in	
770/1/WO/3	100x150 cm 39.4x60 in	
770/1/WO/4	100x175 cm 39.4x70 in	
770/1/WO/5	120x200 cm 47.2x78.7 in	

REF*	↕ ↔	↕	📏	53 cm 20.9 in
770/1/WO/1	80x100 cm 31.5x39.3 in	174 cm 68.5 in	7 Kg 15.4 Lb	
770/1/WO/2	100x120 cm 39.4x47.2 in			
770/1/WO/3	120x150 cm 47.2x60 in			
770/1/WO/5	120x200 cm 47.2x78.7 in			

*La referencia incluye solo los soportes
The reference includes only the supports
La référence comprend uniquement les supports
Il riferimento include solo i supporti

Marcos de aluminio / Aluminium frames

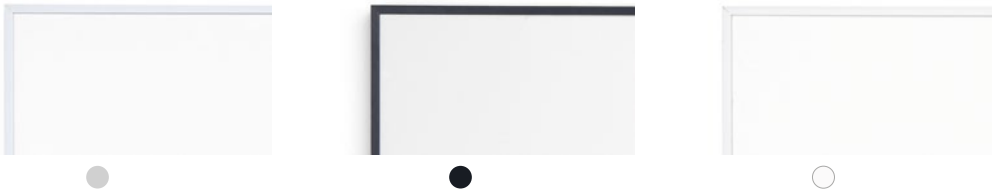

PARED / WALL	PIZARRA BLANCA / WHITEBOARD					RAIL	T	Y2	AV	→ ←
	●	●	○	↕ ↔	⚖					2,3 cm 0.9 in
	724/10	724/10/AN	724/10/BL	40x60 cm 15.7x23.6 in	2,4 Kg 5.2 Lb					
	724/1	724/1/AN	724/1/BL	60x80 cm 23.6x31.5 in	4.8 Kg 10.5 Lb					
	724/2	724/2/AN	724/2/BL	80x100 cm 31.5x39.3 in	8 Kg 17.6 Lb	•	•	•		
	724/3	724/3/AN	724/3/BL	100x120 cm 39.3x47.2 in	12 Kg 26.4 Lb	•	•	•		
	724/4	724/4/AN	724/4/BL	100x150 cm 39.3x60 in	15 Kg 33 Lb	•	•	•		
	724/5	724/5/AN	724/5/BL	100x175 cm 39.3x70 in	17.5 Kg 38.5 Lb	•	•	•		
724/6	724/6/AN	724/6/BL	120x200 cm 47.2x78.7 in	24Kg 52.9 Lb						

PARED / WALL	PIZARRA DE TIZA / CHALKBOARD					RAIL	T	Y2	AV	→ ←
	●	●	○	↕ ↔	⚖					2,3 cm 0.9 in
	734/10	734/10/AN	734/10/BL	40x60 cm 15.7x23.6 in	2,4 Kg 5.2 Lb					
	734/1	734/1/AN	734/1/BL	60x80 cm 23.6x31.5 in	4.8 Kg 10.5 Lb					
	734/2	734/2/AN	734/2/BL	80x100 cm 31.5x39.3 in	8 Kg 17.6 Lb	•	•	•		
	734/3	734/3/AN	734/3/BL	100x120 cm 39.3x47.2 in	12 Kg 26.4 Lb	•	•	•		
	734/4	734/4/AN	734/4/BL	120x150 cm 47.2x60 in	16 Kg 35 Lb	•	•	•		
	734/5	734/5/AN	734/5/BL	120x200 cm 47.2x78.7 in	24 Kg 53 Lb					
734/6	734/6/AN	734/6/BL	120x250 cm 47.2x98.4 in	27Kg 59.5 Lb						

MÁS DETALLES SOBRE EL SOPORTE / MORE DETAILS ABOUT THE SUPPORT

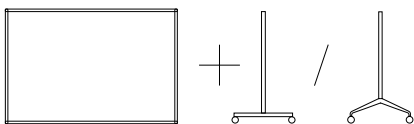

Slim board

Soportes metálicos / Metallic supports

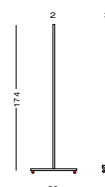

SOPORTE / SUPPORT



PIZARRA BLANCA / WHITEBOARD

MEDIDAS DISPONIBLES / AVAILABLE SIZES

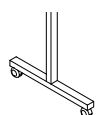

770/1/GR



770/1/AN



770/1/BL



80x100 cm
31.5x39.3 in

100x120 cm
39.3x47.2 in

100x150 cm
39.3x60 in

100x175 cm
39.3x70 in

120x200 cm
47.2x78.7 in



174 cm
68.5 in

7 Kg
15.4 Lb

53 cm
20.9 in

SOPORTE / SUPPORT



PIZARRA DE TIZA / CHALKBOARD

MEDIDAS DISPONIBLES / AVAILABLE SIZES

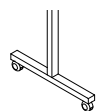

770/1/GR



770/1/AN



770/1/BL



80x100 cm
31.5x39.3 in

100x120 cm
39.3x47.2 in

120x150 cm
47.2x60 in

120x200 cm
47.2x78.7 in



174 cm
68.5 in

7 Kg
15.4 Lb

53 cm
20.9 in



Pizarra magnética clásica - Tableau magnétique classique - Lavagna magnetica classica

Soportes de aluminio / Aluminium supports

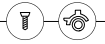
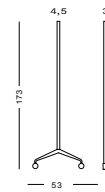

SOPORTE / SUPPORT PIZARRA BLANCA / WHITEBOARD MEDIDAS DISPONIBLES / AVAILABLE SIZES



	●	●	○	↕ ↔	↕	📊	
Y2/80/R	Y2/80/R/AN	Y2/80/R/BL	80x100 cm 31.5x39.3 in	173 cm 68.1 in	5 Kg 11 Lb	53 cm 20.9 in	
Y2/120/R	Y2/120/R/AN	Y2/120/R/BL	100x120 cm 39.3x47.2 in	173 cm 68.1 in	6 Kg 13.2 Lb		
Y2/150/R	Y2/150/R/AN	Y2/150/R/BL	100x150 cm 39.3x60 in	173 cm 68.1 in	6,5 Kg 14.3 Lb		
Y2/200/R	Y2/200/R/AN	Y2/200/R/BL	120x200 cm 47.2x78.7 in	173 cm 68.1 in	7 Kg 15.4 Lb		
Y2/250/R	Y2/250/R/AN	Y2/250/R/BL	120x250 cm 47.2x96.7 in	173 cm 68.1 in	7,5 Kg 16.5 Lb		

SOPORTE / SUPPORT PIZARRA DE TIZA / CHALKBOARD MEDIDAS DISPONIBLES / AVAILABLE SIZES



	●	●	○	↕ ↔	↕	📊	
Y2/80/R	Y2/80/R/AN	Y2/80/R/BL	80x100 cm 31.5x39.3 in	173 cm 68.1 in	5 Kg 11 Lb	53 cm 20.9 in	
Y2/120/R	Y2/120/R/AN	Y2/120/R/BL	100x120 cm 39.3x47.2 in	173 cm 68.1 in	6 Kg 13.2 Lb		
Y2/150/R	Y2/150/R/AN	Y2/150/R/BL	120x150 cm 47.2x60 in	173 cm 68.1 in	6,75 Kg 14.8 Lb		
Y2/200/R	Y2/200/R/AN	Y2/200/R/BL	120x200 cm 47.2x78.7 in	173 cm 68.1 in	7 Kg 15.4 Lb		
Y2/250/R	Y2/250/R/AN	Y2/250/R/BL	120x250 cm 47.2x96.7 in	173 cm 68.1 in	7,5 Kg 16.5 Lb		



Classic Magnetic Board



Pizarra mural blanca o verde, fabricada en acero vitrificado de alta calidad para escritura y borrado en seco. Enmarcada con perfil clásico de aluminio y cantoneras de plástico gris. Incluye cajetín reposa rotuladores de 30 cm. y está disponible en 11 medidas. Superficie magnética disponible en acabado brillante y mate para proyección. Pizarra ideal para el sector educativo al llegar a 4 metros en una pieza.

White or green drawing board, made from high quality vitrified steel for writing and dry erasing. Framed with Classic aluminium profile and grey plastic corner pieces. It includes 30 cm marker box and it is available in 11 sizes. Magnetic surface available in gloss and matt finish for projection. Ideal drawing board for the education sector reaching 4 meters in one piece.

Tableau mural blanc ou vert, en acier émaillé de haute qualité pour marqueurs effaçables à sec ou craie. Encadré avec profil en aluminium Classic et des pièces d'angle en plastique gris. Comprend un auget pour marqueurs de 30 cm. 11 dimensions disponibles. Surface magnétique disponible en finition brillante ou mate pour la projection. Tableau idéal pour le secteur de l'éducation, allant jusqu'à 4 mètres d'un seul tenant.

Lavagna da disegno bianca o verde, realizzata in acciaio vetrificato di alta qualità per scrivere e cancellare a secco. Incorniciata con profilo classico in alluminio e angoli in plastica grigia. Include una scatola per pennarelli da 30 cm ed è disponibile in 11 formati. Superficie magnetica disponibile con finitura lucida e opaca per la proiezione. Lavagna da disegno ideale per il settore dell'istruzione che raggiunge i 4 metri in un unico pezzo.

Medidas / Sizes

PARA PIZARRA BLANCA / FOR WHITEBOARD

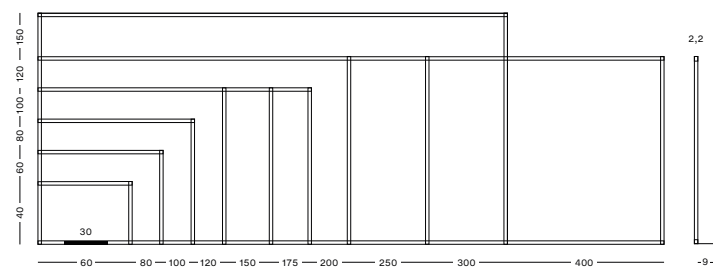

PARA PIZARRA DE TIZA / FOR CHALKBOARD

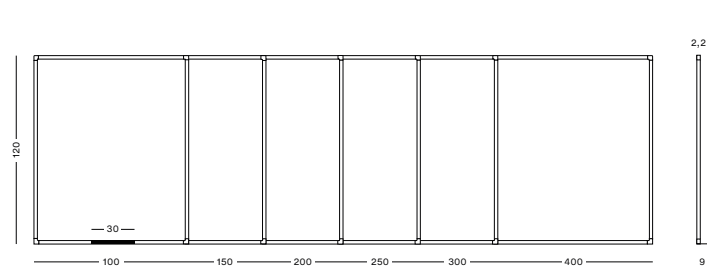

Especificaciones / Specifications

PIZARRA BLANCA / WHITEBOARD



PIZARRA DE TIZA / CHALKBOARD



Classic Magnetic Board

Marcos de aluminio / Aluminium frames



PARED / WALL  PIZARRA BLANCA / WHITEBOARD							 PIZARRA DE TIZA / CHALKBOARD							→ ←
REF	MATT	↕ ↔		RAIL	T	Y2	REF	↕ ↔		RAIL	T	Y2	2,2 cm 0.8 in	
720/10		40x60 cm 15.7x23.6 in	2,5 Kg 5.6 Lb				730/A1	120x100 cm 47.2x78.7 in	12,8 Kg 28.21 Lb	•	•	•		
720/1		60x80 cm 23.6x31.4 in	5,1 Kg 11.2 Lb				730/A2	120x150 cm 47.2x78.7 in	16 Kg 35.2 Lb	•	•	•		
720/2		80x100 cm 31.4x39.3 in	8,5 Kg 18.7 Lb	•	•	•	730/A3	120x200 cm 47.2x78.7 in	25,6 Kg 56.4 Lb		•	•		
720/3		100x120 cm 39.3x47.2 in	12,8 Kg 28.21 Lb	•	•	•	730/A4	120x250 cm 47.2x98.4 in	32 Kg 70.5 Lb					
720/4	720/4/M	100x150 cm 39.3x59.05 in	16 Kg 35.2 Lb	•	•	•	730/A5	120x300 cm 47.2x118.1 in	38,4 Kg 84.6 Lb					
720/5		100x175 cm 39.3x68.8 in	18,6 Kg 41 Lb	•	•	•	730/A6	120x400 cm 47.2x157.48 in	51,2 Kg 112.8 Lb					
720/6	720/6/M	120x200 cm 47.2x78.7 in	25,6 Kg 56.4 Lb		•	•								
720/7	720/7/M	120x250 cm 47.2x98.4 in	32 Kg 70.5 Lb											
720/8	720/8/M	120x300 cm 47.2x118.1 in	38,4 Kg 84.6 Lb											
720/9	720/9/M	120x400 cm 47.2x157.48 in	51,2 Kg 112.8 Lb											
720/15	720/15/M	150x300 cm 59.05x118.1 in	48 Kg 105.8 Lb											

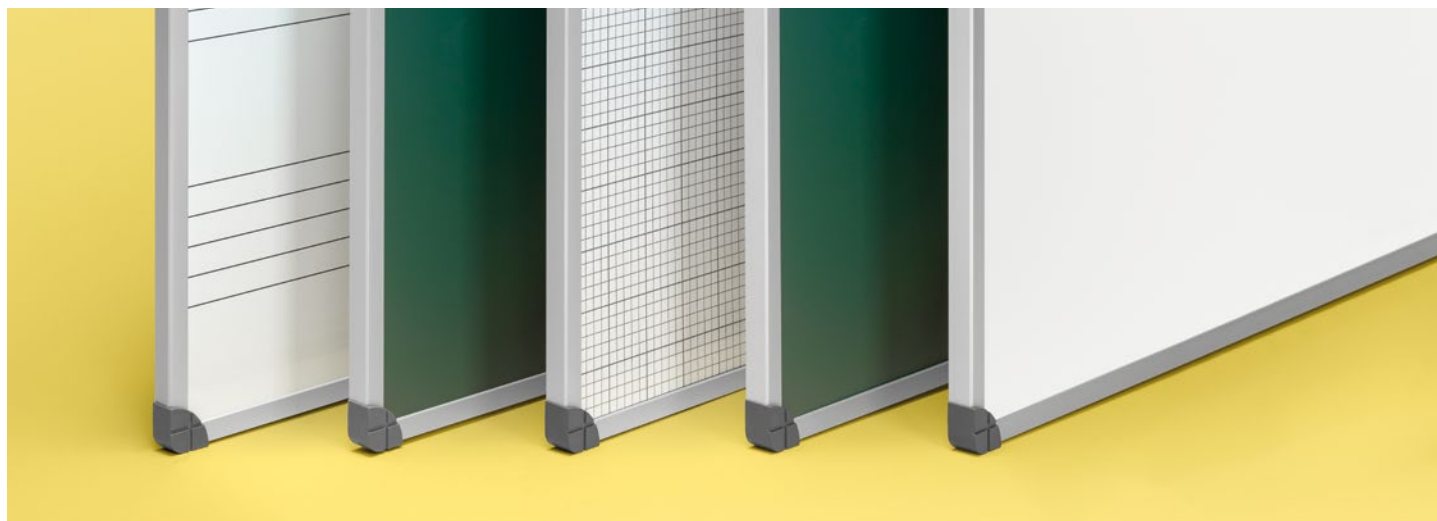

Tablero cuadriculado & pentagrama / Grid Board & Stave

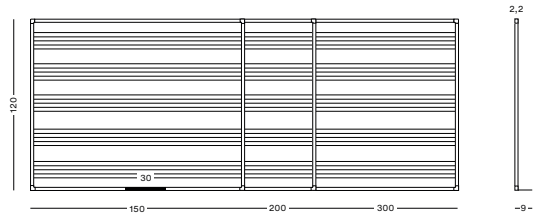
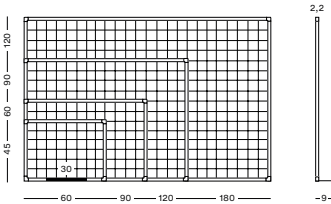
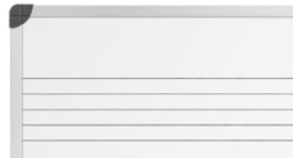
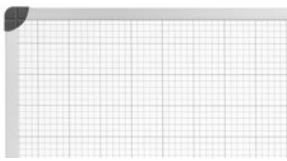

PARED / WALL



PIZARRA BLANCA / WHITEBOARD

AV

			RAIL	T	Y2				RAIL	T	Y2
720/C1	45x60 cm 17.7x23.6 in	2,5 Kg 5.6 Lb				720/P1	120x150 cm 47.2x59 in	19,2 Kg 42.3 Lb	•	•	•
720/C2	60x90 cm 23.6x35.4 in	5,1 Kg 11.2 Lb	•			720/P2	120x200 cm 47.2x78.7 in	25,6 Kg 56.4 Lb		•	•
720/C3	90x120 cm 35.9x47.2 in	8,5 Kg 18.7 Lb	•	•	•	720/P3	120x300 cm 47.2x118.1 in	38,4 Kg 84.6 Lb			
720/C4	120x180 cm 47.2x71 in	12,8 Kg 28.21 Lb	•	•	•						

MÁS DETALLES SOBRE EL SOPORTE / MORE DETAILS ABOUT THE SUPPORT

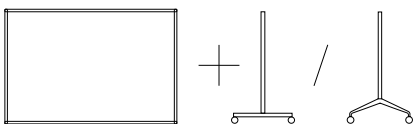

Classic Board



Pizarra mural blanca o verde, fabricada en laminado de alta calidad para escritura con rotuladores de borrado en seco o tiza. Enmarcada con perfil de aluminio Classic y cantoneras de plástico gris. Incluye cajetín reposa rotuladores de 30 cm. y están disponibles en múltiples medidas. Las más grandes están fabricadas en 2 piezas.

White or green wall board, made using high quality laminate for writing with dry erase markers or chalk. Framed with Classic aluminium profile and grey plastic corner. It includes a 30 cm tray for markers and they are available in multiple sizes. The largest boards are made using 2 sections.

Tableau mural blanc ou vert, fabriqué en stratifié de haute qualité pour marqueurs effaçables à sec ou craie. Encadré avec profil en aluminium classique et des coins en plastique gris. Comprend un auget pour marqueurs de 30 cm. Disponible en plusieurs dimensions. Les plus grands sont fabriqués en 2 pièces.

Lavagna da parete bianca o verde, realizzata in laminato di alta qualità per scrivere con pennarelli cancellabili a secco o gessetti. Incorniciata con profilo classico in alluminio e angoli in plastica grigia. Include una scatola per pennarelli da 30 cm. e sono disponibili in più misure. Le più grandi sono realizzate in 2 pezzi.



Classic Board

Medidas / Sizes

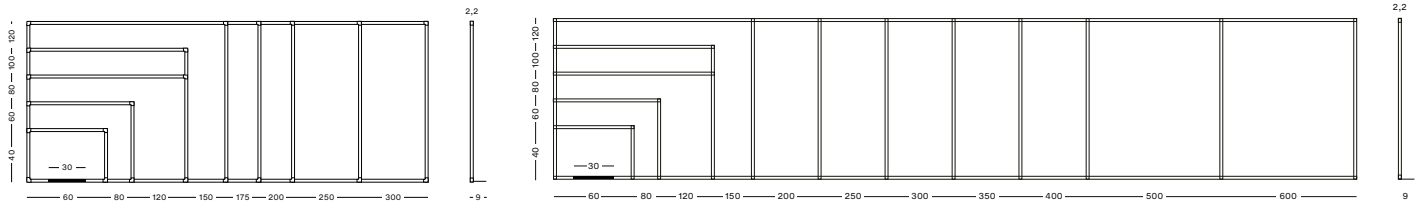

Especificaciones / Specifications

PIZARRA BLANCA / WHITEBOARD

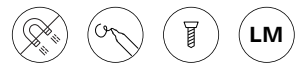

PIZARRA DE TIZA / CHALKBOARD

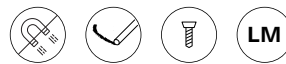

Marcos de aluminio / Aluminium frames



PARED / WALL						PIZARRA DE TIZA / CHALKBOARD						
PIZARRA BLANCA / WHITEBOARD						PIZARRA DE TIZA / CHALKBOARD						
LM	↕ ↔	⚖	RAIL	T	Y2	LM	↕ ↔	⚖	RAIL	T	Y2	2,2 cm 0.8 in
725/1	40x60 cm 15.74x23.6 in	2,5 Kg 5.5 Lb				730/11	40x60 cm 15.7x23.6 in	2,5 Kg 5.5 Lb				
725/2	60x80 cm 23.6x31.4 in	4,8 Kg 10.5 Lb				730/12	60x80 cm 23.6x31.4 in	4,8 Kg 10.5 Lb				
725/3	80x120 cm 31.4x47.2 in	9,6 Kg 21.1 Lb	•	•	•	730/1	80x120 cm 31.4x47.2 in	9,6 Kg 21.1 Lb	•	•	•	
725/4	100x120 cm 39.3x47.2 in	12 Kg 26.4 Lb	•	•	•	730/2	100x120 cm 39.3x47.2 in	12 Kg 26.4 Lb	•	•	•	
725/5	120x150 cm 47.2x59.0 in	17 Kg 37.4 Lb	•	•	•	730/3	120x150 cm 47.2x59.05 in	17 Kg 37.4 Lb	•	•	•	
725/6	120x175 cm 47.2x68.8 in	22,5 Kg 49.6 Lb	•	•	•	730/4	120x200 cm 47.2x78.7 in	25,6 Kg 56.4 Lb			•	•
725/7	120x200 cm 47.2x78.7 in	25,6 Kg 56.4 Lb			•	730/5	120x250 cm 47.2x98.4 in	28 Kg 61.7 Lb				
725/8	120x250 cm 47.2x98.4 in	28 Kg 61.7 Lb				730/6	120x300 cm 47.2x118.1 in	32 Kg 70.5 Lb				
725/9	120x300 cm 47.2x118.1 in	32 Kg 70.5 Lb				730/7*	120x350 cm 47.2x137.7 in	40 Kg 88.1 Lb				
						730/8*	120x400 cm 47.2x157.48 in	48 Kg 105.8 Lb				
						730/9*	120x500 cm 47.2x196.8 in	60 Kg 132.2 Lb				
						730/10*	120x600 cm 47.2x236.2 in	62 Kg 136.6 Lb				

* Fabricado en 2 piezas
 Made from 2 pieces
 Fabriqué en 2 pièces
 Realizzato in 2 pezzi

TERMINACIÓN "PIN BOARD" / AVAILABLE IN "PIN BOARD" FINISH



→ PÁGINA / PAGE: 94

MÁS DETALLES SOBRE EL SOPORTE / MORE DETAILS ABOUT THE SUPPORT

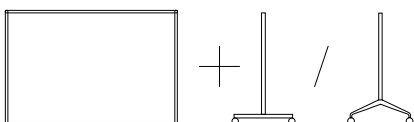

→ PÁGINA / PAGE: 80

R · PET Board

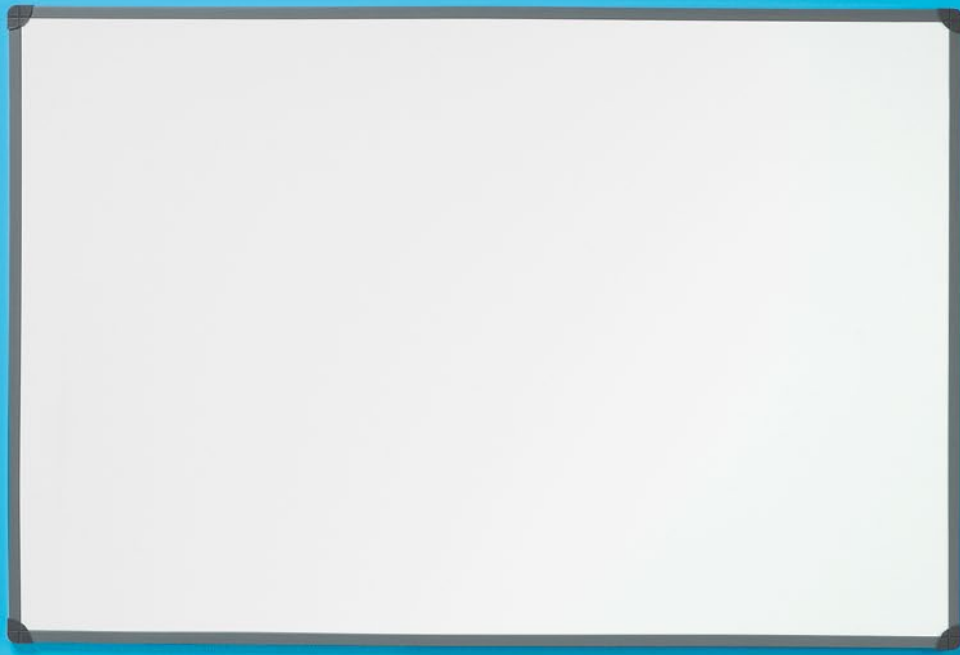

Pizarra mural de acero vitrificado o laminado, disponible en blanco o verde, fabricada con extrusión de perfil e inyección de cantoneras de R-PET. El PET que usamos en las pizarras proviene de botellas y envases 100% reciclados con el fin de mejorar la sostenibilidad del planeta invirtiendo en unos nuevos productos de larga vida útiles en el sector de la docencia y la formación.

Vitrified or laminated steel & slate drawing board, available in white or green, manufactured with profile extrusion and injection of R-PET corner pieces. The PET we use comes from 100% recycled bottles and containers in order to improve the sustainability of the planet by investing in new long-life products for education and training sectors.

Tableau mural en acier émaillé ou stratifié, disponible en blanc ou vert, fabriqué avec extrusion de profil et injection de pièces d'angle R-PET. Le PET que nous utilisons pour nos tableaux provient de bouteilles et d'emballages 100% recyclés. En investissant dans de nouveaux produits longue durée pour le secteur de l'enseignement et de la formation, nous contribuons à l'amélioration de la durabilité de notre planète.

Lavagna da disegno in acciaio e ardesia vetrificata o laminata, disponibile in bianco o verde, prodotta con estrusione di profili e iniezione di pezzi angolari in R-PET. Il PET che utilizziamo proviene da bottiglie e imballaggi riciclati al 100%, per migliorare la sostenibilità del pianeta investendo in nuovi prodotti di lunga durata nel settore educativo e formativo.

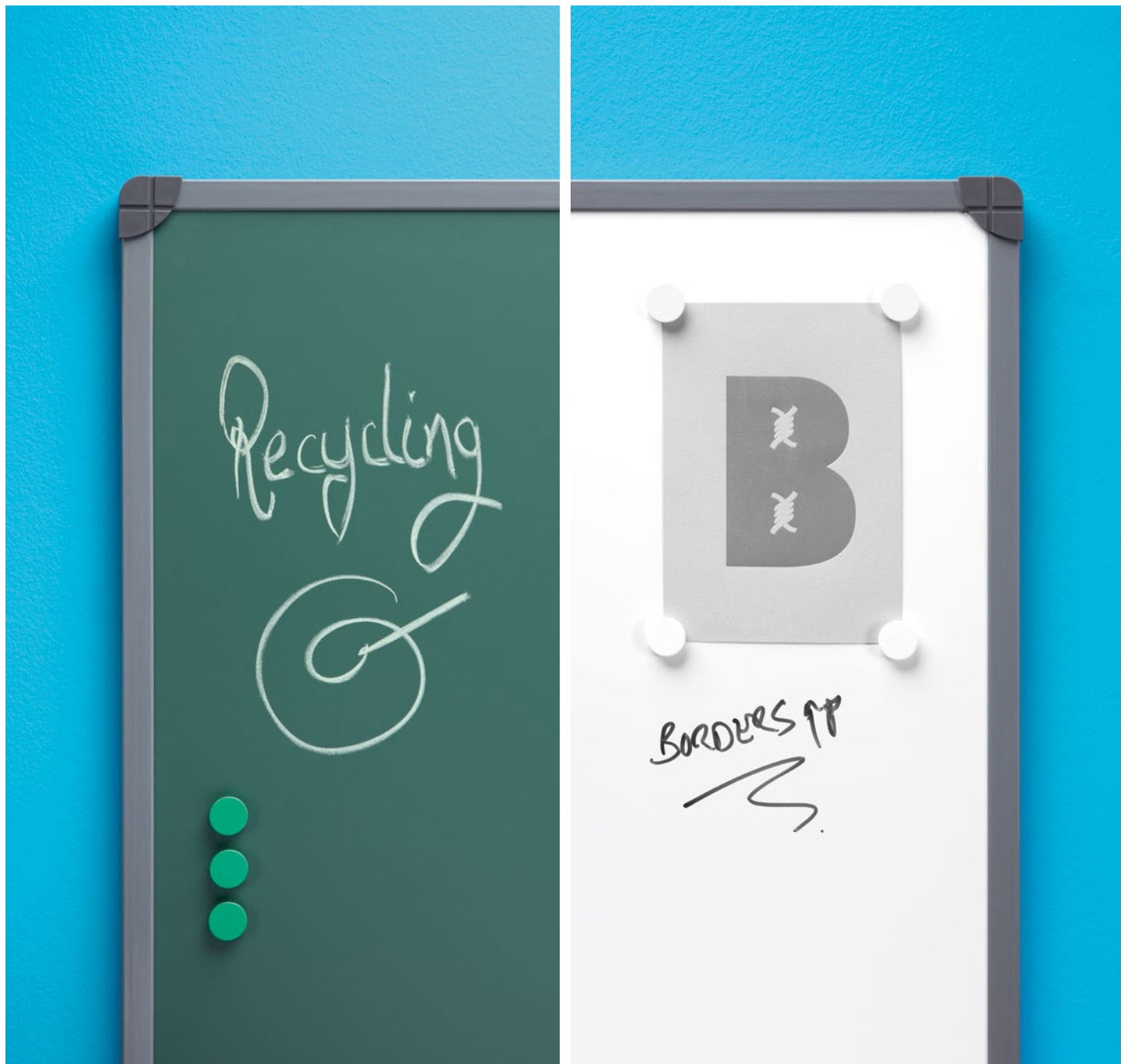

R · PET Board

Medidas / Sizes

PARA PIZARRA BLANCA / FOR WHITEBOARD

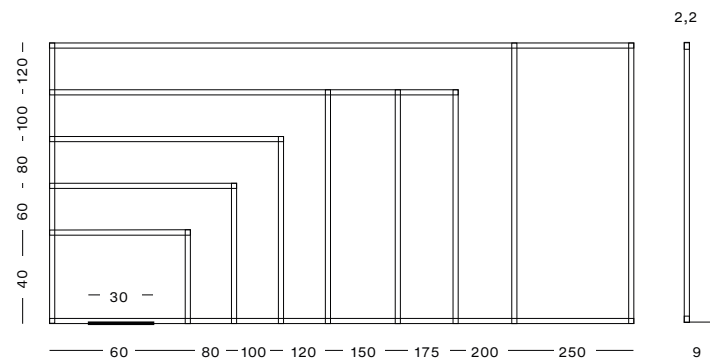

PARA PIZARRA DE TIZA / FOR CHALKBOARD

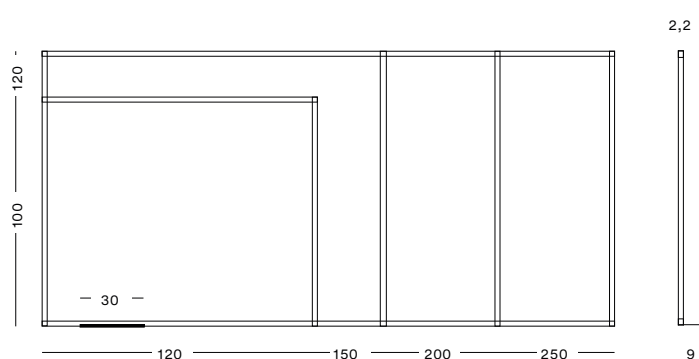

Especificaciones / Specifications

PARA PIZARRA BLANCA / FOR WHITEBOARD



PARA PIZARRA DE TIZA / FOR CHALKBOARD



Marco & esquinas reciclados / Recycled frames and frame corners



PARED / WALL

PIZARRA BLANCA / WHITEBOARD

AV

REF	MATT	↕ ↔	📏
720/10/REC	-	40x60 cm 15.7x23.6 in	2,5 Kg 5.6 Lb
720/1/REC	-	60x80 cm 23.6x31.4 in	5,1 Kg 11.2 Lb
720/2/REC	-	80x100 cm 31.4x39.3 in	8,5 Kg 18.7 Lb
720/3/REC	-	100x120 cm 39.3x47.2 in	12,8 Kg 28.21 Lb
720/4/REC	720/4/M/REC	100x150 cm 39.3x59.05 in	16 Kg 35.2 Lb
720/5/REC	-	100x175 cm 39.3x68.8 in	18,6 Kg 41 Lb
720/6/REC	720/6/M/REC	120x200 cm 47.2x78.7 in	25,6 Kg 56.4 Lb
720/7/REC	720/7/M/REC	120x250 cm 47.2x98.4 in	32 Kg 70.5 Lb

PIZARRA DE TIZA / CHALKBOARD

AV

↔ ↕

REF	↕ ↔	📏	2,2 cm 0.8 in
730/A1/REC	100x120 cm 39.3x47.2 in	12,8 Kg 28.21 Lb	
730/A2/REC	120x150 cm 47.2x59.05 in	18 Kg 39.6 Lb	
730/A3/REC	120x200 cm 47.2x78.7 in	25,6 Kg 56.4 Lb	
730/A4/REC	120x250 cm 47.2x98.4 in	32 Kg 70.5 Lb	

720+725/Rec · 730+730/A/Rec

PARED / WALL

PIZARRA BLANCA / WHITEBOARD



PIZARRA DE TIZA / CHALKBOARD



REF	↕ ↔	👤
725/1/REC	40x60 cm 15.7x23.6 in	2,5 Kg 5.5 Lb
725/2/REC	60x80 cm 23.6x31.4 in	4,8 Kg 10.5 Lb
725/3/REC	80x120 cm 31.4x47.2 in	9,6 Kg 21.1 Lb
725/4/REC	100x120 cm 39.3x47.2 in	12 Kg 26.6 Lb
725/5/REC	120x150 cm 47.2x59.05 in	15 Kg 37.4 Lb
725/6/REC	120x175 cm 47.2x68.8 in	22,5 Kg 49.6 Lb
725/7/REC	120x200 cm 47.2x78.7 in	25,6 Kg 56.4 Lb
725/8/REC	120x250 cm 47.2x98.4 in	28 Kg 61.7 Lb

REF	↕ ↔	👤
730/1/REC	100x120 cm 39.3x47.2 in	12 Kg 26.6 Lb
730/2/REC	120x150 cm 47.2x59.05 in	17 Kg 37.4 Lb
730/3/REC	120x200 cm 47.2x78.7 in	25,6 Kg 56.4 Lb
730/4/REC	120x250 cm 47.2x98.4 in	28 Kg 61.7 Lb

2,2 cm
0.8 in



RPET



RPVC



WOOD



Rail Plan



Rail Plan es un perfil de aluminio lacado blanco, fijado a la pared, el cual permite colgar en sus dos carriles pizarras y tableros, pudiendo desplazarlos longitudinalmente para conseguir un espacio polivalente en las presentaciones y reuniones en una sala, aula u oficina. Además incorpora un carril inferior para sujetar pósters o planos sin dañarlos.

Rail Plan is a white lacquered aluminium profile, fixed to the wall, which allows blackboards and boards to be hung on its two rails, allowing easy movement longitudinally to achieve a multipurpose space for presentations and meetings in board rooms, classrooms or the office. It also incorporates a lower rail to hold posters or plans without damaging them.

Rail Plan est un profile en aluminium laqué blanc fixé au mur, qui permet d'accrocher des tableaux blancs et des tableaux d'affichage sur ses deux rails, et de pouvoir les déplacer longitudinalement pour réaliser un espace polyvalent pour des présentations et des réunions dans une salle, une classe ou un bureau. Il intègre également un rail inférieur pour accrocher des affiches ou des plans sans les endommager.

Rail Plan è un profilo in alluminio laccato bianco, fissato alla parete, che permette di appendere lavagne e pannelli sui suoi due binari, consentendo un facile spostamento in senso longitudinale per ottenere uno spazio multifunzionale per presentazioni e riunioni in sale riunioni, aule o uffici. Inoltre, incorpora un binario inferiore per sostenere poster o progetti senza danneggiarli.



Rail Plan

Medidas / Sizes

Especificaciones / Specifications

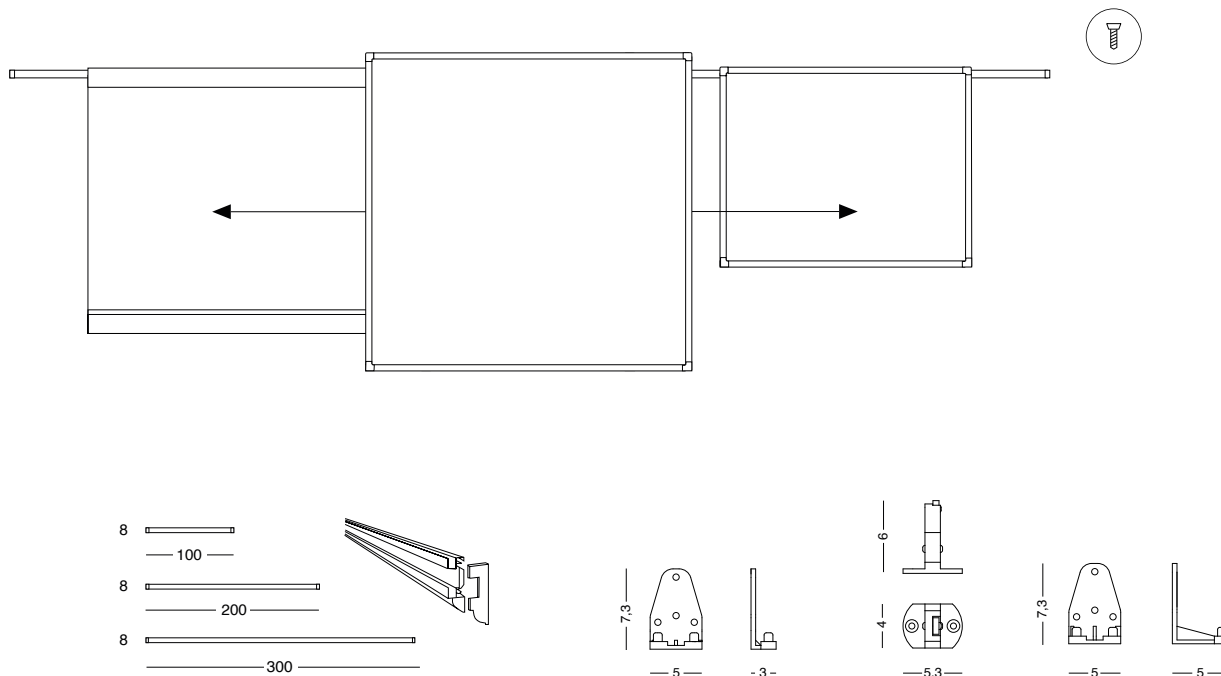

PARED / WALL

REF	Dimensions	Weight
RP/000	- x8 cm - x3 in	1 Kg 2.2 Lb
RP/100	8x100 cm 2x39.4 in	1 Kg 2.2 Lb
RP/200	8x200 cm 3x78.7 in	2 Kg 4.4 Lb
RP/300	8x300 cm 3x118 in	3 Kg 6.6 Lb

REF	Dimensions	Angle
RP/30	2,5x5 cm 1x2 in	90°
RP/L	5x8 cm 2x3 in	90°



Tableros compatibles / Compatible boards

PIZARRA BLANCA / FOR WHITEBOARD

PIZARRA DE TIZA / FOR CHALKBOARD

TABLERO DE ANUNCIOS / FOR PINBOARD

TABLERO DE ANUNCIOS / FOR PINBOARD

Slim Board → PÁGINA / PAGE: 14

Slim Pinboard → PÁGINA / PAGE: 86

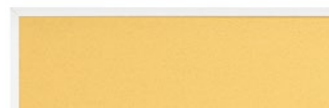

Classic Magnetic Board → PÁGINA / PAGE: 20

Classic Pinboard → PÁGINA / PAGE: 92

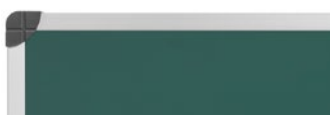
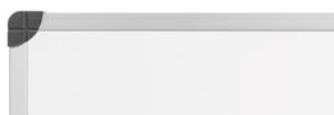

R·Pet Board → PÁGINA / PAGE: 28

R·PET Pinboard → PÁGINA / PAGE: 96

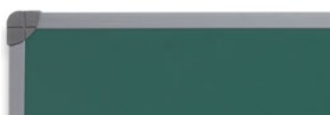
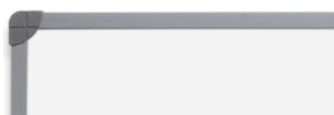

Zenit Board → PÁGINA / PAGE: 36

Zenit Pinboard → PÁGINA / PAGE: 100

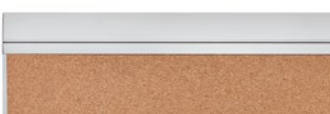
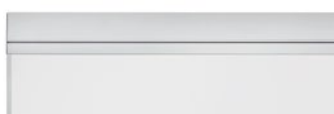

Zenit Board

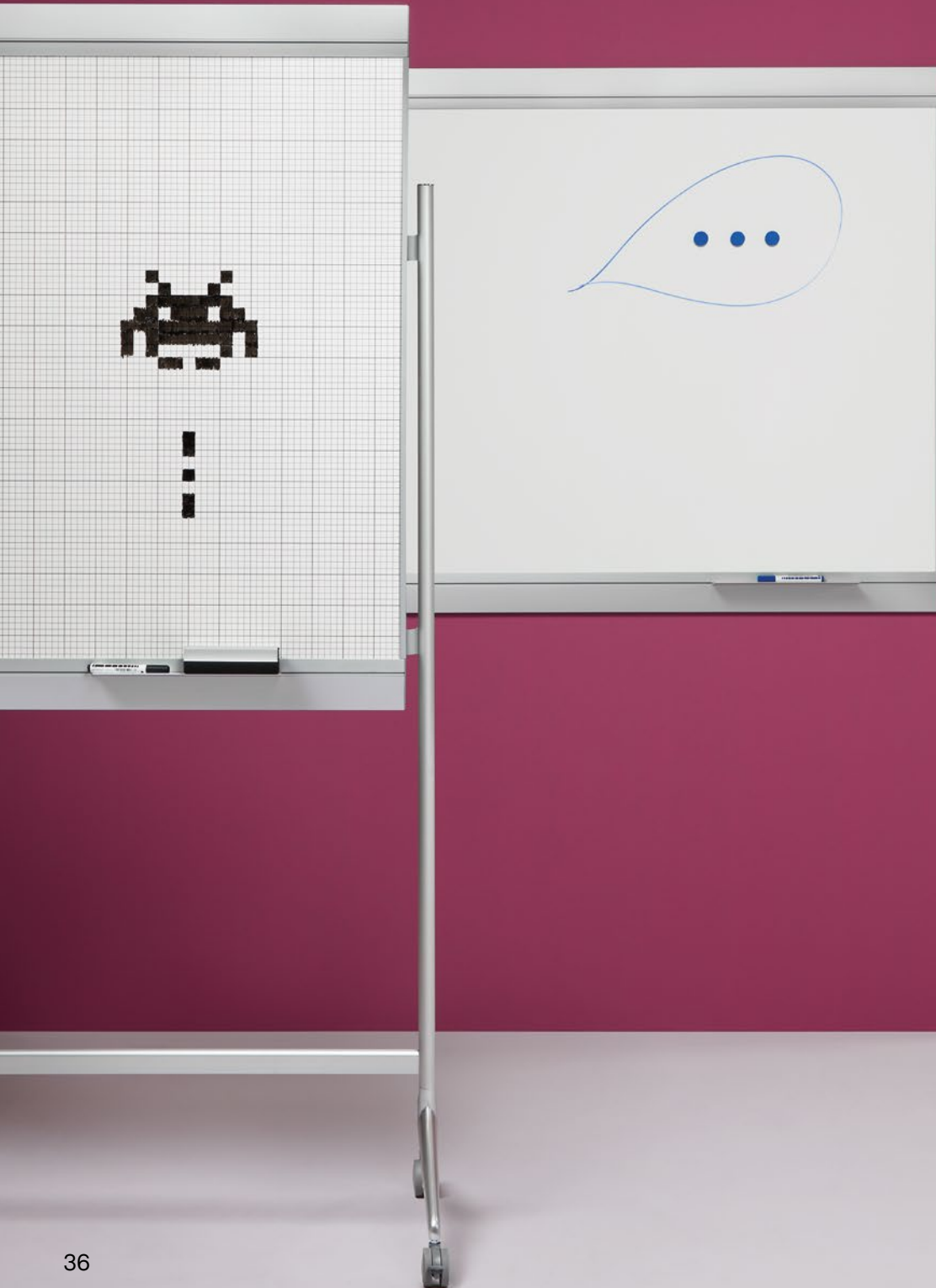

Pizarra mural Zenit de acero vitrificado o laminada, blanca o verde para uso con rotulador de borrado en seco o tiza según opción. Perfilera de aluminio con anclajes ocultos anodizada en color plata mate, incluye cajetín reposa rotuladores de 30 cm. La opción magnética permite uso de imanes.

Zenit wall board made from vitrified or laminated steel, white or green for use with a dry erase marker or chalk depending on the option you choose. Aluminium profile with hidden anchors anodized in matt silver colour, it includes 30 cm marker holder box. The magnetic option allows the use of magnets.

Tableau mural Zenit en acier émaillé ou stratifié, blanc ou vert à utiliser avec un marqueur effaçable à sec ou craie selon la superficie. Profilé en aluminium anodisé couleur argent mat, fixation invisible, comprend un auget porte-marqueur de 30 cm. L'option magnétique permet l'utilisation d'aimants.

Lavagna a parete Zenit in acciaio vetrificato o laminato, bianca o verde, da utilizzare con pennarello cancellabile a secco o gesso a seconda dell'opzione scelta. Profilo in alluminio con ancoraggi nascosti anodizzati in colore argento opaco, include scatola porta pennarelli da 30 cm. L'opzione magnetica consente l'uso di magneti.

Medidas / Sizes

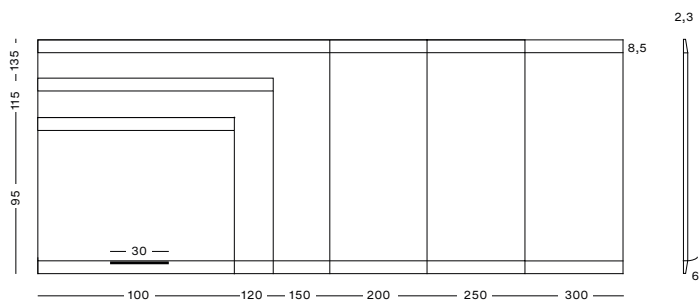
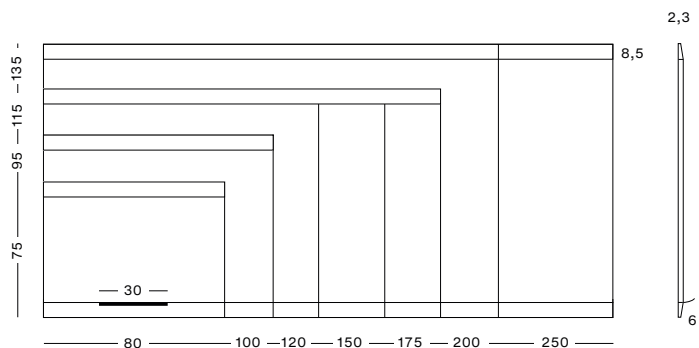

Especificaciones / Specifications

PARA PIZARRA BLANCA / FOR WHITEBOARD



PARA PIZARRA DE TIZA / FOR CHALKBOARD



Zenit Board

Marcos de aluminio / Aluminium frames



PARED / WALL						PIZARRA DE TIZA / CHALKBOARD						→ ←
PIZARRA BLANCA / WHITEBOARD												
AV	LM	↕ ↔	📏	RAIL	Y2	AV	LM	↕ ↔	📏	RAIL	Y2	2,3 cm 0.9 in
Z/720/1	Z/725/1	60x80 cm 23.6x31.4 in	6,7 Kg 14.7 Lb			Z/730/A0	Z/730/0	80x100 cm 31.4x39.3 in	11,5 Kg 25.3 Lb	•	•	
Z/720/2	Z/725/2	80x100 cm 31.4x39.3 in	11,5 Kg 25.3 Lb	•	•	Z/730/A1	Z/730/1	100x120 cm 39.3x47.2 in	16 Kg 35.2 Lb	•	•	
Z/720/3	Z/725/3	100x120 cm 39.3x47.2 in	16 Kg 35.2 Lb	•	•	Z/730/A2	Z/730/2	120x150 cm 47.2x59.05 in	20 Kg 44.09 Lb	•	•	
Z/720/4	Z/725/4	100x150 cm 39.3x59.05 in	20 Kg 44.04 Lb	•	•	Z/730/A3	Z/730/3	120x200 cm 47.2x78.7 in	23 Kg 50.7 Lb			•
Z/720/5	Z/725/5	100x175 cm 39.3x68.8 in	23 Kg 50.7 Lb	•		Z/730/A4	Z/730/4	120x250 cm 47.2x98.4 in	31 Kg 68.3 Lb			
Z/720/6	Z/725/6	120x200 cm 47.2x78.7 in	31 Kg 68.3 Lb		•	Z/730/A5	Z/730/5	120x300 cm 47.2x118.11 in	38 Kg 83.7 Lb			
Z/720/7	Z/725/7	120x250 cm 47.2x98.4 in	38 Kg 83.7 Lb									



Tableros cuadriculados & pentagramas / Grid Boards & Staves



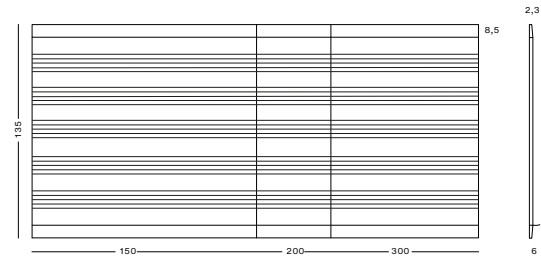
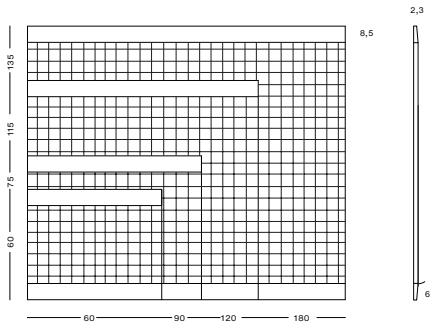
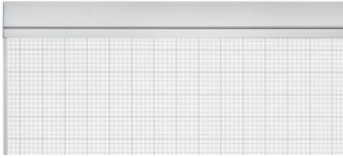

AV



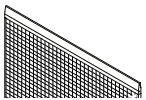



PARED / WALL

 PIZARRA BLANCA / WHITEBOARD

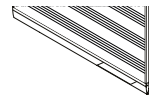

				RAIL	Y2
Z/720/C1		45x60 cm 17.7x23.6 in	4 Kg 8.8 Lb		
Z/720/C2		60x90 cm 23.6x35.4 in	7,8 Kg 17.1 Lb		
Z/720/C3		90x120 cm 35.9x47.2 in	15,5 Kg 34.1 Lb	•	
Z/720/C4		120x180 cm 47.2x71 in	31 Kg 68.3 Lb	•	•



				RAIL	Y2
Z/720/P1		120x150 cm 47.2x59 in	26 Kg 57.3 Lb	•	•
Z/720/P2		120x200 cm 47.2x78.7 in	35 Kg 77.1 Lb		•
Z/720/P3		120x300 cm 47.2x118.1 in	50 Kg 110.2 Lb		

MÁS DETALLES SOBRE EL SOPORTE / MORE DETAILS ABOUT THE SUPPORT

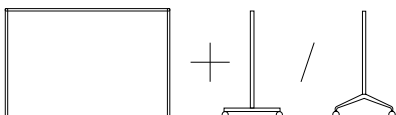

Diptic & Triptic Boards



Pizarra mural diptica o tríptica de acero vitrificado blanca o verde para uso con rotulador de borrado en seco o tiza. Enmarcadas con perfil de aluminio plata mate y cantoneras redondeadas de plástico gris, incluyen cajetín reposa rotuladores de 30 cm. 3 ó 5 superficies de escritura según formato y son aptas para uso de material magnético.

White or green Vitrified Steel diptych or triptych drawing board for use with dry erase pens or chalk. Framed with a matt silver aluminium profile and rounded grey plastic corners, they include a 30 cm marker box. 3 or 5 writing surfaces depending on the format and suitable for the use of magnetic material.

Tableau mural diptyque ou triptyque en acier émaillé blanc ou vert à utiliser avec des marqueurs effaçables à sec ou de la craie. Encadré avec un profil en aluminium argent mate et des coins arrondis en plastique gris, inclus un auget pour marqueurs de 30 cm. 3 ou 5 surfaces d'écriture selon le format. Surface magnétique adaptée aux aimants.

Lavagna da disegno dittico o trittico in acciaio vetrificato bianco o verde da utilizzare con cancellini a secco o gessetti. Incorniciate da un profilo in alluminio argento opaco e da angoli arrotondati in plastica grigia, includono una scatola per pennarelli da 30 cm. 3 o 5 superfici di scrittura a seconda del formato e sono adatte all'uso di materiale magnetico.



Diptic & Triptic Boards

Medidas diptico / diptych sizes

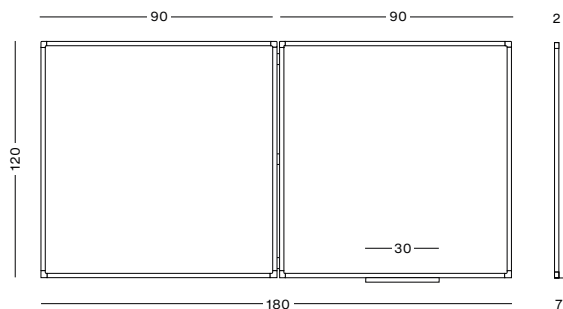

Marco de aluminio / Aluminium frame



Especificaciones / Specifications

PARA PIZARRA BLANCA / FOR WHITEBOARD



PARED / WALL

PIZARRA BLANCA / WHITEBOARD

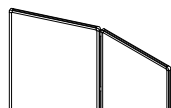

REF	⇕ ⇔ OPEN	⇕ ⇔ CLOSE	👤
720/D1	90x120 cm 35.4x47.2 in	90x60 cm 35.4x23.6 in	16 Kg 35.2 Lb
720/D2	120x180 cm 47.2x70.8 in	120x90 cm 47.2x35.4 in	24 Kg 52.9 Lb



Medidas tríptico / triptych sizes

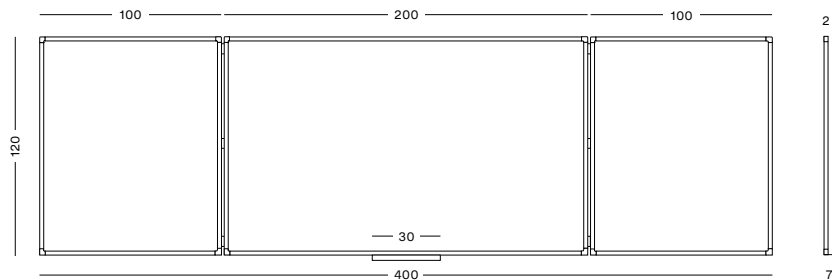

Marco de aluminio / Aluminium frame



Especificaciones / Specifications

PARA PIZARRA BLANCA / FOR WHITEBOARD



PARED / WALL



PIZARRA BLANCA / WHITEBOARD

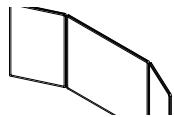

REF	⇕ ⇔ OPEN	⇕ ⇔ CLOSE	👤
720/T1	90x240 cm 35.4x94.4 in	90x120 cm 35.4x47.2 in	32 Kg 70.5 Lb
720/T2	120x400 cm 47.2x157.4 in	120x200 cm 47.2x78.7 in	51 Kg 112.4 Lb



Rotating Board

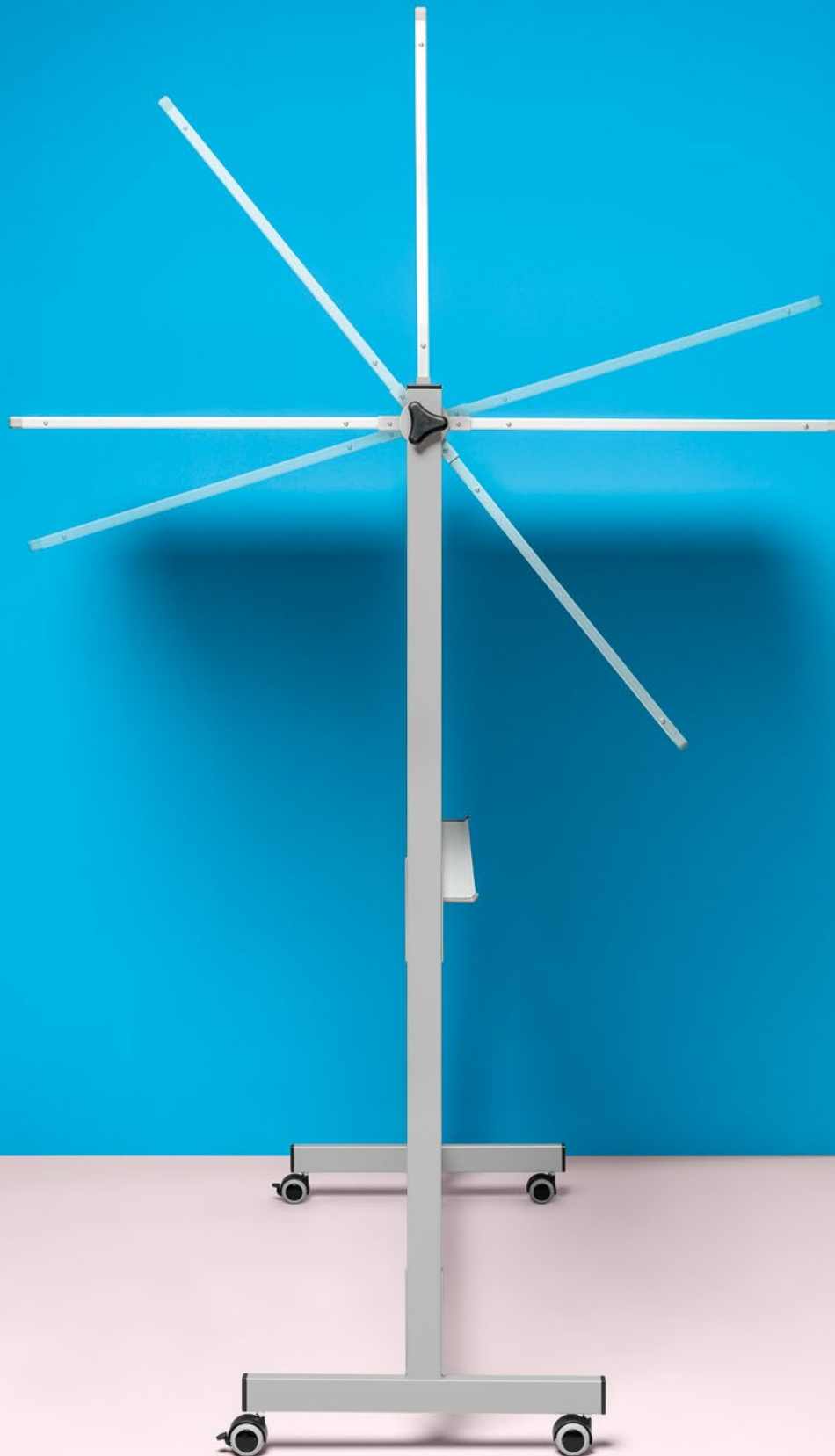



Pizarra doble cara volteable de acero vitrificado o laminada, blanca o verde para uso con rotulador de borrado en seco o tiza según opción. Estructura metálica gris giratoria provista de 4 ruedas, 2 de ellas con freno. Enmarcada con perfil de aluminio anodizado plata mate y cantoneras redondeadas de plástico gris. Incluye pomo de fijación y bloqueo a presión.

Flip-up double-sided board made of vitrified or laminated steel, white or green, for use with a dry erase marker or chalk as options. Rotating grey metallic structure provided with 4 castors, 2 of them with brakes. Framed with a matt silver anodized aluminium profile and rounded grey plastic corner pieces. Includes clamping handle and snap lock.

Tableau pivotant double face en acier émaillé ou stratifié, blanc ou vert, à utiliser avec un marqueur effaçable à sec ou une craie selon l'option. Structure métallique grise pivotante dotée de 4 roues dont 2 avec freins. Tableau encadré avec un profil en aluminium anodisé argent mat et des coins arrondis en plastique gris. Comprend une poignée de serrage et un verrou à pression.

Lavagna bifacciale ribaltabile in acciaio vetrificato o laminato, bianca o verde, da utilizzare con pennarello cancellabile a secco o gesso come opzione. Struttura metallica grigia girevole dotata di 4 rotelle, 2 con freno. Profilo in alluminio anodizzato argento opaco e angoli arrotondati in plastica grigia. Include maniglia di fissaggio e chiusura a scatto.

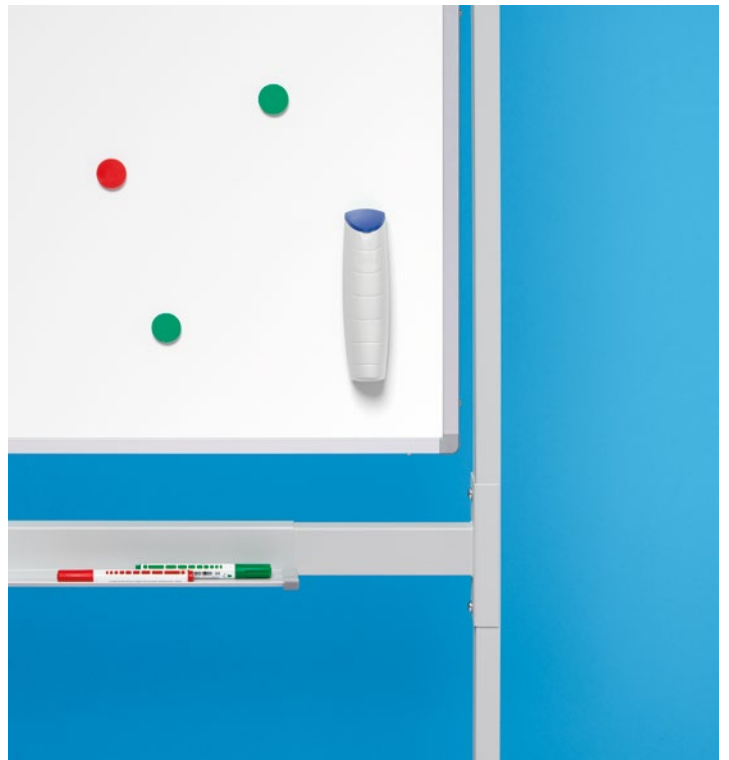

Rotating Board

Medidas / Sizes

Marco de aluminio / Aluminium frame

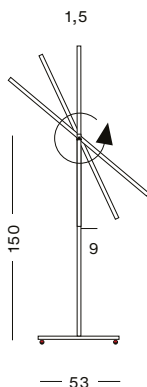
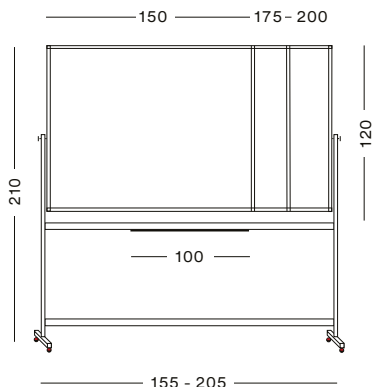

Especificaciones / Specifications

PARA PIZARRA BLANCA / FOR WHITEBOARD



PARA PIZARRA DE TIZA / FOR CHALKBOARD



PIZARRA BLANCA / WHITEBOARD

→ ←

→ ←



AV	LM	↕ ↔ BOARD	↕	⚖		
720/X1	725/X1	120x150 cm 47,2x59,0 in	210 cm 85.6 in	45 Kg 99.2 Lb	1,5 cm 0.59 in	53 cm 20.8 in
720/X2	725/X2	120x175 cm 47,2x68,8 in	210 cm 85.6 in	53 Kg 116.8 Lb		
720/X3	725/X3	120x200 cm 47,2x78,7 in	210 cm 85.6 in	61 Kg 134.5 Lb		



PIZARRA DE TIZA / CHALKBOARD

→ ←

→ ←

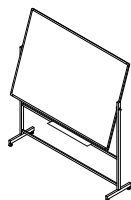

AV	LM	↕ ↔ BOARD	↕	⚖		
730/A/X1	730/X1	120x150 cm 47,2x59,0 in	210 cm 85.6 in	45 Kg 99.2 Lb	1,5 cm 0.59 in	53 cm 20.8 in
730/A/X2	730/X2	120x175 cm 47,2x68,8 in	210 cm 85.6 in	53 Kg 116.8 Lb		
730/A/X3	730/X3	120x200 cm 47,2x78,7 in	210 cm 85.6 in	61 Kg 134.5 Lb		





Vaiven Board



Pizarra de Vaivén fabricada en acero vitrificado blanca para rotuladores de borrado en seco o verde para tiza. Estructura de aluminio montada sobre suelo y pared. Las pizarras se deslizan con facilidad y van guiadas en los perfiles por rodamientos de nylon. Ideales para colegios, universidades, anfiteatros, auditorios... Las dos pizarras van compensadas la una con la otra. Cuando una sube la otra baja y viceversa.

Vaivén blackboard made from white vitrified steel for dry erase markers or green for chalk. Aluminium structure wall or floor mounted. The boards slide easily and are guided in the profiles by nylon bearings. Ideal for schools, universities, amphitheatres, auditoriums... The two blackboards are offset one with the other. When one goes up the other goes down and vice versa.

Tableau Vaivén en acier émaillé blanc pour marqueurs effaçables à sec ou vert pour craie. Structure en aluminium fixée au sol et au mur. Les tableaux coulissent facilement et sont guidés dans les profilés par des roulements en nylon. Idéal pour les écoles, universités, amphithéâtres, auditoriums. Les deux tableaux se compensent l'un avec l'autre. Quand l'un monte, l'autre descend et vice versa.

Lavagna Vaivén in acciaio vetrificato bianco per pennarelli a secco o verde per gessetti. Struttura in alluminio montata a parete o a filo muro. Le lavagne scorrono facilmente e sono guidate nei profili da cuscinetti in nylon. Ideale per scuole, università, anfiteatri, auditorium... Le due lavagne sono sfalsate l'una rispetto all'altra. Quando una sale l'altra scende e viceversa.

Medidas / Sizes

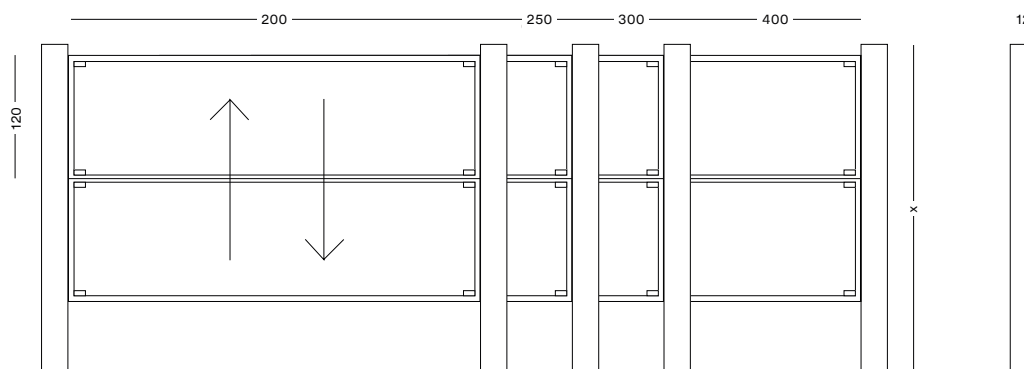

Especificaciones / Specifications

PARA PIZARRA BLANCA / FOR WHITEBOARD



PARA PIZARRA DE TIZA / FOR CHALKBOARD



PARED / WALL

PIZARRA BLANCA / WHITEBOARD

PIZARRA DE TIZA / CHALKBOARD

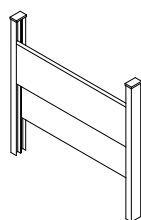

REF	↕ ↔	⚖
720/2/VV1	120x200 cm 47.2x78.7 in	191 Kg 86.6 Lb
720/2/VV2	120x250 cm 47.2x98.4 in	223 Kg 101.1 Lb
720/2/VV3	120x300 cm 47.2x118.1 in	256 Kg 116.1 Lb
720/2/VV4	120x400 cm 47.2x157.48 in	349 Kg 158.3 Lb

REF	↕ ↔	⚖	12 cm 4.7 in
730/2/VV1	120x200 cm 47.2x78.7 in	191 Kg 86.6 Lb	
730/2/VV2	120x250 cm 47.2x98.4 in	223 Kg 101.1 Lb	
730/2/VV3	120x300 cm 47.2x118.1 in	256 Kg 116.1 Lb	
730/2/VV4	120x400 cm 47.2x157.48 in	349 Kg 158.3 Lb	

Guillotine Board



Pizarra de Guillotina fabricada en acero vitrificado blanca para rotuladores de borrado en seco o verde para tiza. Estructura de aluminio montada sobre suelo y pared. Las pizarras se deslizan con facilidad y van guiadas en los perfiles por rodamientos de nylon. Ideales para colegios, universidades, anfiteatros, auditorios... Las dos pizarras van compensadas de manera independiente. Pueden mantenerse una arriba la otra abajo, o las dos en la misma altura.

Guillotine board made from white vitrified steel for dry erase markers or green for chalk. Aluminium structure for wall and or floor mounting. The boards slide easily and are guided within the profiles using nylon bearings. Ideal for schools, universities, amphitheatres, auditoriums... The two boards are independently compensated. They can be kept one above the other below, or both at the same height.

Tableau "Guillotine" fabriqué en acier émaillé blanc pour les marqueurs effaçables à sec ou vert pour la craie. Structure en aluminium fixée au sol et au mur. Les tableaux coulissent facilement et sont guidés dans les profilés par des roulements en nylon. Idéal pour les écoles, universités, amphithéâtres, auditoriums. Les deux tableaux sont indépendants. Ils peuvent être maintenus l'un en haut et l'autre en bas, ou les deux à la même hauteur.

Lavagna a ghigliottina in acciaio vetrificato bianco per pennarelli a secco o verde per gessetti. Struttura in alluminio per il montaggio a parete o a pavimento. Le lavagne scorrono facilmente e sono guidate nei profili da cuscinetti in nylon. Ideale per scuole, università, anfiteatri, auditorium... Le due lavagne sono compensate in modo indipendente. Possono essere tenute una sopra l'altra sotto, o entrambe alla stessa altezza.

Medidas / Sizes

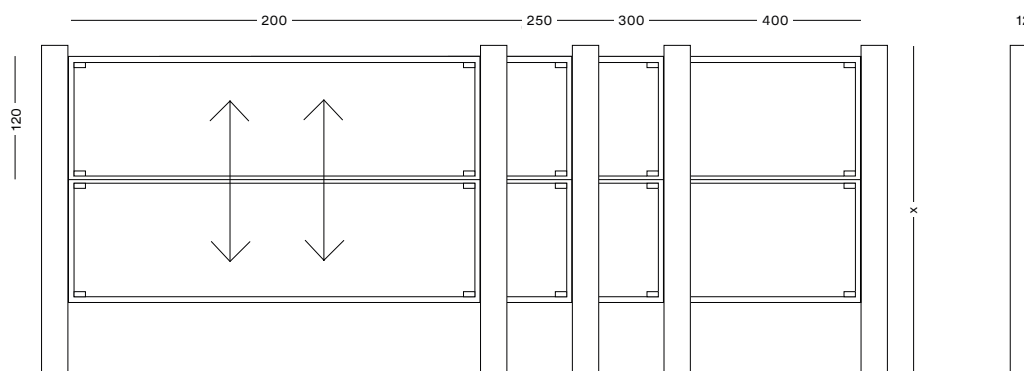

Especificaciones / Specifications

PARA PIZARRA BLANCA / FOR WHITEBOARD



PARA PIZARRA DE TIZA / FOR CHALKBOARD



PARED / WALL

PIZARRA BLANCA / WHITEBOARD

PIZARRA DE TIZA / CHALKBOARD

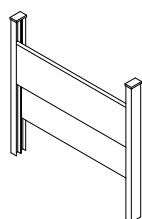

REF	↕ ↔	⚖
720/2/G1	120x200 cm 47.2x78.7 in	210 Kg 462.2 Lb
720/2/G2	120x250 cm 47.2x98.4 in	226 Kg 498.2 Lb
720/2/G3	120x300 cm 47.2x118.1 in	236 Kg 520.2 Lb
720/2/G4	120x400 cm 47.2x157.48 in	255 Kg 562.1 Lb

REF	↕ ↔	⚖	12 cm 4.7 in
730/A2/G1	120x200 cm 47.2x78.7 in	210 Kg 462.2 Lb	
730/A2/G2	120x250 cm 47.2x98.4 in	226 Kg 498.2 Lb	
730/A2/G3	120x300 cm 47.2x118.1 in	236 Kg 520.2 Lb	
730/A2/G4	120x400 cm 47.2x157.48 in	255 Kg 562.1 Lb	

Basic Board

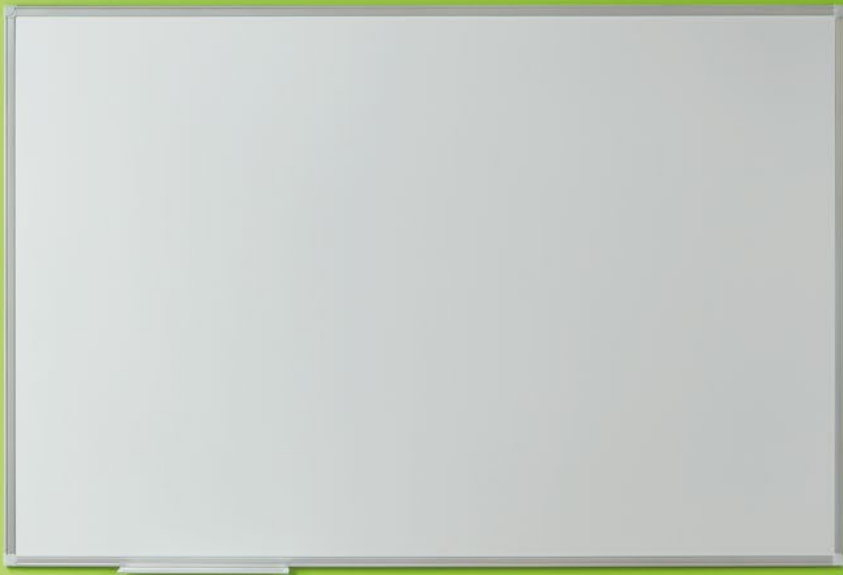

Pizarra Basic lacada blanca. Rotulable en seco. Magnética. Incluye cajetín reposa rotuladores de 30 cm. Enmarcada con perfil de aluminio anodizado en color plata mate y cantoneras redondeadas de plástico gris.

Basic lacquered white board. Magnetic lacquered surface for writing with dry erase markers. Framed with matt silver anodized aluminium profile and grey plastic corner pieces. Includes 30 cm marker tray. It allows magnetic material.

Tableau blanc laqué Basic. Surface laquée magnétique pour marqueurs effaçables à sec. Encadré avec un profil en aluminium anodisé argent mat et des coins en plastique gris. Il comprend un auget pour marqueurs de 30 cm. Superficie magnétique.

Lavagna bianca laccata di base. Superficie magnetica laccata per scrivere con pennarelli cancellabili a secco. Cornice con profilo in alluminio anodizzato argento opaco e angoli in plastica grigia. Include un vassoio per pennarelli da 30 cm. Consente l'uso di materiale magnetico.

Medidas / Sizes

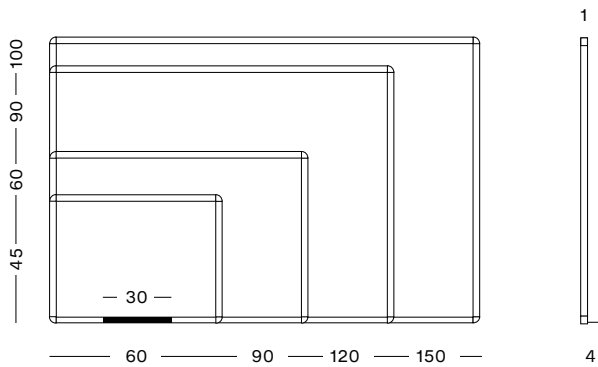

Especificaciones / Specifications

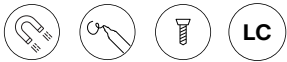

Marco de aluminio / Aluminium frame

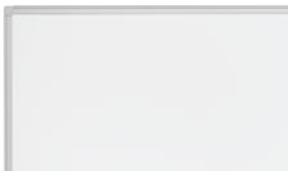

PARED / WALL  PIZARRA BLANCA / WHITEBOARD 

REF	↕ ↔	⚖	1 cm
BL/VI/0010	45x60 cm 17.7x23.6 in	2 Kg 4.4 Lb	0.4 in
BL/VI/0011	60x90 cm 23.6x35.4 in	4 Kg 8.82 Lb	
BL/VI/0012	90x120 cm 35.4x47.2 in	8 Kg 17.64 Lb	
BL/VI/0013	100x150 cm 39.3x59 in	11 Kg 24.25 Lb	



Chameleon

La superficie de una pizarra Chameleon consta de varios componentes que se fabrican junto con una doble capa de esmalte a 800 °C contra una fina lámina de metal. Esto crea una superficie robusta que es perfecta para usar como pizarra blanca.

A Chameleon whiteboard surface consists of several components which are forged together with a double enamel layer at 800 °C against a thin metal sheet. This creates a robust surface which is perfect for whiteboard use.

Une surface de tableau blanc Chameleon se compose de plusieurs composants qui sont forgés ensemble avec une double couche d'émail à 800 °C contre une fine feuille de métal. Cela crée une surface robuste qui est parfaite pour une utilisation sur tableau blanc.

La superficie di una lavagna bianca Chameleon è composta da diversi componenti che vengono forgiati insieme con un doppio strato di smalto a 800 °C contro una sottile lamiera metallica. Questo crea una superficie robusta che è perfetta per l'uso della lavagna.





Personalizada: Encaja en su interior al milímetro: una pizarra blanca Chameleon se puede cortar en cualquier forma.

Customised: Fitting into your interior to the millimetre: a Chameleon whiteboard can be cut into any shape.

Sur mesure : S'intègre dans votre intérieur au millimètre près : un tableau blanc Chameleon peut être découpé dans n'importe quelle forme.

Personalizzato: Si adatta al millimetro ai tuoi interni: una lavagna bianca Chameleon può essere tagliata in qualsiasi forma.



Garantía: Las pizarras blancas Chameleon son resistentes y fáciles de mantener limpias durante toda su vida y su montaje es fácil de usar.

Warranty: Chameleon whiteboards are durable and easy to keep clean throughout their lifespan, and their assembly is user-friendly.

Garantie : Les tableaux blancs Chameleon sont résistants et faciles à entretenir tout au long de leur vie, et leur montage est convivial.

Garanzia: Le lavagne bianche Chameleon sono robuste e facili da mantenere pulite per tutta la loro durata, e il loro montaggio è facile da utilizzare.

Propiedades / Properties



Construcción / Construction

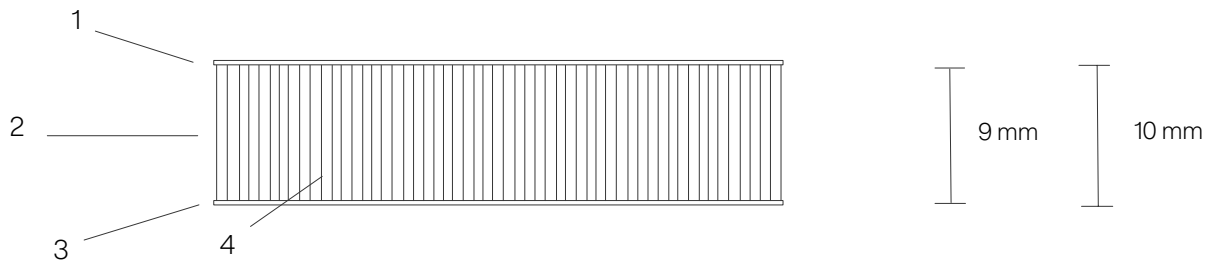

1. Superficie: Enamel (acero vitrificado) 0,4 ~ 0,6 mm / Enamel surface (vitrified steel) 0.4~0.6mm
2. Estructura: MDF 9 mm Hidrófugo
3. Respaldo: Hoja de acero galvanizado 0,4 mm / Galvanized steel sheet 0.4 mm
4. Acabados: Esquinas lacadas sellantes en blanco / White sealing lacquered corners

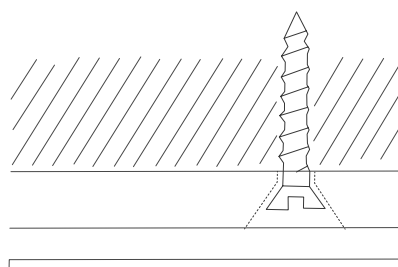

Placa de montaje con agujeros para atornillar
Mounting plate with holes for screwing

Chameleon Custom



$$-P_r(1-\cos\varphi); \quad \frac{P_r^3}{EJ} \frac{(1-\cos\alpha)^2}{2};$$

$$P \cos \varphi$$

$$\frac{P_r^3}{EJ} \left(\frac{3}{2} a - 2 \sin\alpha + \frac{\sin 2\alpha}{4} \right);$$

$$M_i = -\frac{q x_i^2}{2}; \quad \bar{M}_i = -l \cdot x_i;$$

$$\frac{P_r^2}{EJ} (\alpha - \sin\alpha);$$

$$\varphi = \frac{EJ}{GJ_k}; \quad \frac{m r}{EJ} \frac{\lambda - l}{2} \sin^2 \alpha;$$

$$\frac{n}{EJ} \left(\frac{1+\lambda}{2} a - \frac{\lambda-l}{4} \sin 2\alpha \right);$$

$$\frac{P_r^2}{EJ} (\alpha - \sin\alpha);$$

$$\frac{m r}{EJ} \frac{\lambda - l}{2} \sin^2 \alpha;$$

$$\frac{n}{EJ} \left(\frac{1+\lambda}{2} a - \frac{\lambda-l}{4} \sin 2\alpha \right);$$

Pizarra con superficie de acero vitrificado blanca. Gracias a que no lleva ningún tipo de marco y que su perfecto corte está realizado con chorro de agua y madera hidrófuga, hace que permita cortarse con la silueta deseada para cubrir el área necesaria, incluso salvar interruptores, extintores, pulsadores... Su superficie magnética permite adaptar imanes.

Blackboard with a white vitrified steel surface. Thanks to the fact that it does not have any frame and that its perfect cut is made using a water jet and water-repellent wood, it allows it to be cut with the desired silhouette to cover the necessary area, even avoid wall-sockets, fire extinguishers, push-buttons ... Its magnetic surface allows you to adapt magnets.

Tableau en acier émaillé blanc. Grâce au fait qu'il n'a pas de cadre et que sa découpe du bois hydrofuge est réalisée au jet d'eau, cela permet de découper toutes les formes que vous souhaitez, et ainsi sauver vos interrupteurs, vos extincteurs et autres boutons poussoirs. Sa surface magnétique vous permet d'utiliser des aimants.

Lavagna con superficie in acciaio vetrificato bianco. Grazie al fatto che non porta alcun tipo di cornice e che il suo taglio perfetto è realizzato con un getto d'acqua e legno idrorepellente, permette di tagliarla con la sagoma desiderata per coprire l'area necessaria, anche per salvare interruttori, estintori, pulsanti... La sua superficie Magnet permette di adattare i magneti.

Medidas / Sizes

CUSTOM

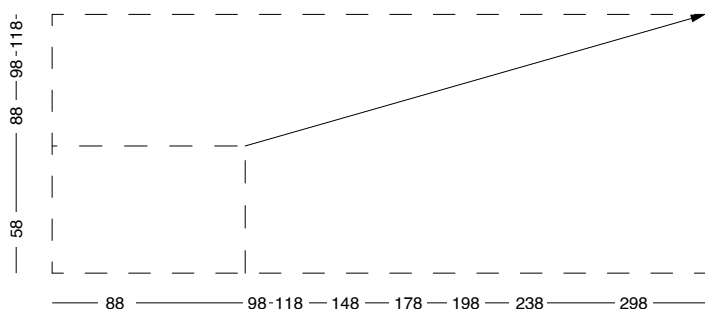

Especificaciones / Specifications



PARED / WALL  PIZARRA BLANCA / WHITEBOARD 

CUSTOM	REF	↕ ↔	1 cm
100% Custom	7200	Máx. 118x298 cm Max. 46.4x117.3 in	0.4 in

PARED / WALL  PIZARRA BLANCA / WHITEBOARD 

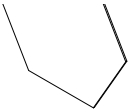
HEXAGONAL	REF	∅	1 cm
	7206/1	60 cm 23.6 in	0.4 in
	7206/2	98 cm 38.6 in	
	7206/3	118 cm 46.5 in	

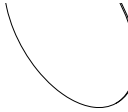
CURVA / CURVE	REF	∅	1 cm
	7208/1	60 cm 23.6 in	0.4 in
	7208/2	98 cm 38.6 in	
	7208/3	118 cm 46.5 in	



HEXAGONAL

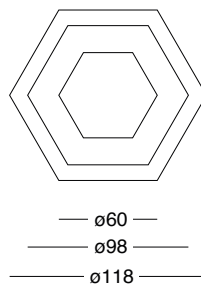

CURVA / CURVE

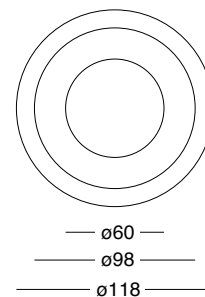

Chameleon Wall



Pizarra con superficie de acero vitrificado blanca modular. Gracias a que no lleva ningún tipo de marco y que su perfecto corte está realizado con chorro de agua y madera hidrófuga, hace que permitan añadirse tantos paneles como sea necesario en el área a cubrir con una unión imperceptible. Disponible en dos alturas y su superficie magnética permite adaptar imanes.

Blackboard with modular white vitrified steel surface. As it does not have any frame, its perfect cut using a water jet and water-repellent wood, it makes it possible to add panels as many as required in the area to be covered with an imperceptible union. It is available in two sizes and its magnetic surface allows to adapt magnets.

Tableau modulaire avec superficie en acier émaillé blanc. Grâce au fait qu'il n'a pas de cadre et que sa découpe en bois hydrofuge est réalisée au jet d'eau, il est possible d'ajouter autant de panneaux que nécessaire dans la zone à couvrir. La séparation entre chaque panneau est imperceptible. Disponible en deux hauteurs. Sa surface magnétique permet d'utiliser des aimants.

Lavagna con superficie modulare in acciaio vetrificato bianco. Grazie all'assenza di qualsiasi tipo di cornice e al taglio perfetto con getto d'acqua e legno idrorepellente, consente di aggiungere pannelli a piacere nell'area da coprire con un'unione impercettibile. Disponibile in due dimensioni, la sua superficie magnetica permette di adattare le calamite.

Medidas / Sizes

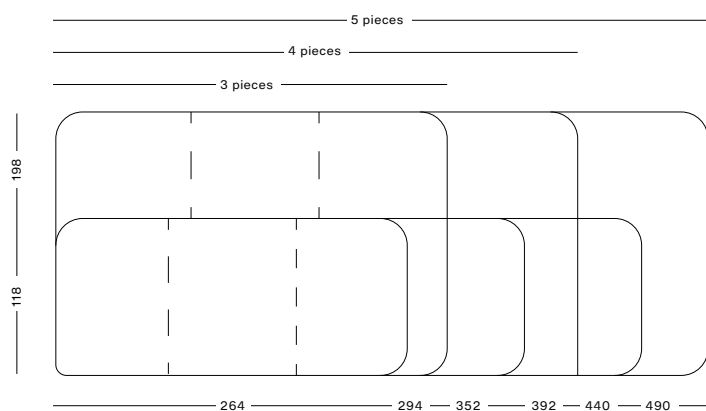

Especificaciones / Specifications



PARED / WALL

PIZARRA BLANCA / WHITEBOARD

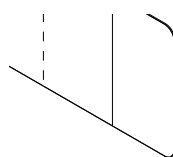

REF	↕ ↔	PANELS	REF	↕ ↔	PANELS	1 cm 0.4 in
7201/1/W3	118x264 cm 46.4x103.9 in	3	7201/5/W3	198x294 cm 77.9x115.7 in	3	
7201/1/W4	118x352 cm 46.4x138.6 in	4	7201/5/W4	198x392 cm 77.9x154.3 in	4	
7201/1/W5	118x440 cm 46.4x173.2 in	5	7201/5/W5	198x490 cm 77.9x192.9 in	5	

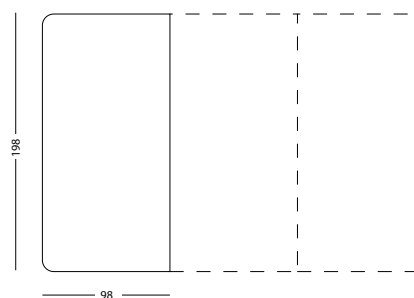
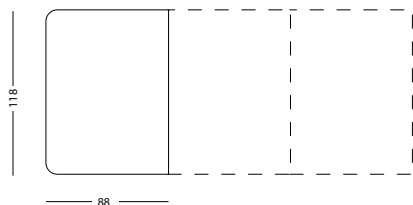

Chameleon Sharp

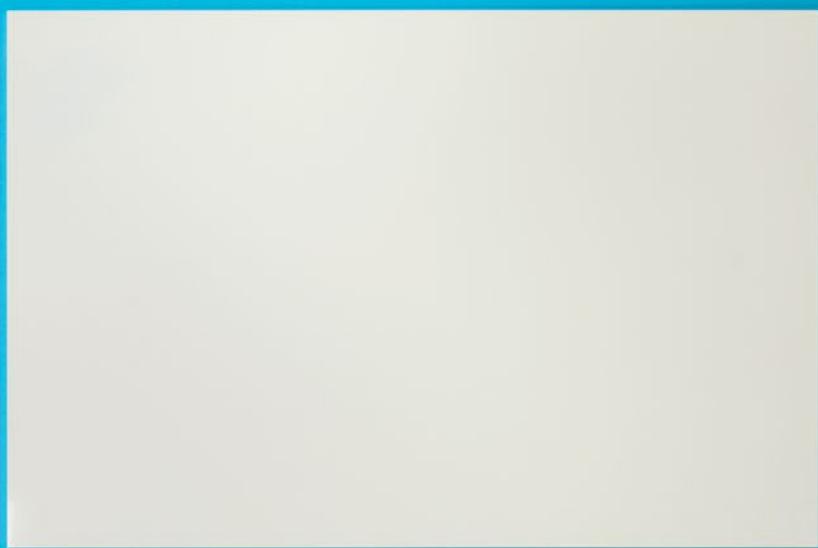

Pizarra de acero vitrificado blanca con esquina de 90° de 10 mm. de grosor sin marco para escritura con rotuladores de borrado en seco. Fabricadas mediante corte de chorro de agua y madera hidrófuga que hace que sus bordes lacados en blanco queden con un acabado perfecto. Superficie magnética con garantía de por vida. Disponible en acabado brillo y mate para proyección.

White vitrified steel slate board with 10 mm 90° corners width without frame for writing with dry erase markers. Manufactured by water jet cutting and water-repellent wood that give their white lacquered edges a perfect finish. Magnetic surface with lifetime warranty. Available in gloss and matt finish for projection.

Tableau en acier émaillé blanc de 10 mm d'épaisseur et angle à 90°, sans cadre pour marqueurs effaçables à sec. Fabriqué en bois hydrofuge et découpé au jet d'eau ce qui lui confère des bords laqués blancs d'une finition parfaite. Surface magnétique garantie à vie. Disponible en finition brillante et mate pour la projection.

Tableau en acier émaillé blanc de 10 mm d'épaisseur et angle à 90°, sans cadre pour marqueurs effaçables à sec. Fabriqué en bois hydrofuge et découpé au jet d'eau ce qui lui confère des bords laqués blancs d'une finition parfaite. Surface magnétique garantie à vie. Disponible en finition brillante et mate pour la projection.

Medidas / Sizes

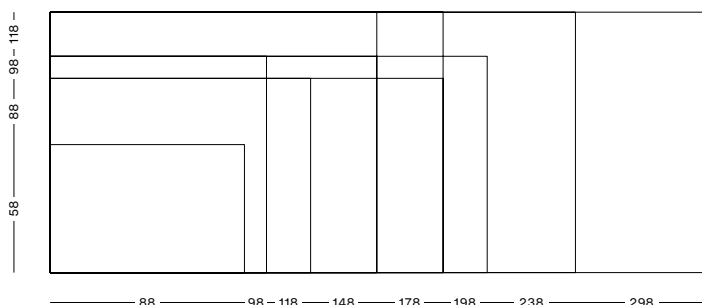

Especificaciones / Specifications



Sin marco / No frame

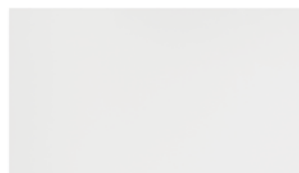
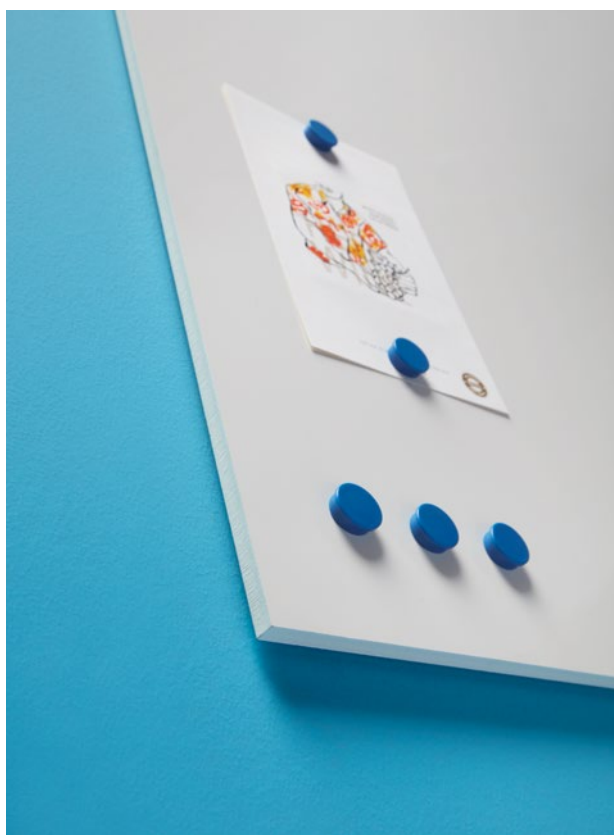

PARED / WALL		PIZARRA BLANCA / WHITEBOARD	↔ ↵	
AV	MATT	↕ ↔	⚖	1 cm 0.4 in
7201/10		58x88 cm 22.8x34.6 in	7,66 Kg 16.8 Lb	
7201/1		88x118 cm 34.6x46.4 in	15,58 Kg 34.3 Lb	
7201/2		88x178 cm 34.6x70 in	23,5 Kg 51.8 Lb	
7201/3		98x98 cm 38.6x38.6 in	15,41 Kg 33.9 Lb	
7201/4		98x148 cm 38.6x58.3 in	21,76 Kg 47.9 Lb	
7201/5		98x198 cm 38.6x80 in	29,11 Kg 64.1 Lb	
7201/6	7201/6/M	118x148 cm 46.4x58.3 in	26,2 Kg 57.7 Lb	
7201/7	7201/7/M	118x178 cm 46.4x70 in	31,51 Kg 69.4 Lb	
7201/8	7201/8/M	118x238 cm 46.4x93.7 in	42,13 Kg 92.8 Lb	
7201/9	7201/9/M	118x298 cm 46.4x117.3 in	52,75 Kg 116.2 Lb	

Chameleon Curve



Medidas / Sizes

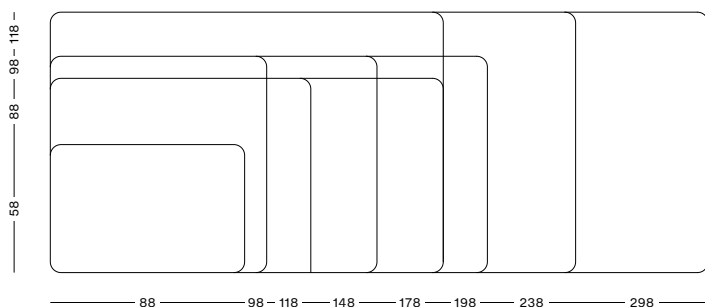

Especificaciones / Specifications



Sin marco / No frame

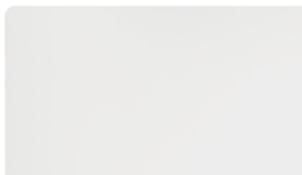

PARED / WALL PIZARRA BLANCA / WHITEBOARD ↔

REF	MATT	↕ ↔	📏	1 cm 0.4 in
7202/10		58x88 cm 22.8x34.6 in	7,66 Kg 16.8 Lb	
7202/1		88x118 cm 34.6x46.4 in	15,58 Kg 34.3 Lb	
7202/2		88x178 cm 34.6x70 in	23,5 Kg 51.8 Lb	
7202/3		98x98 cm 38.6x38.6 in	15,41 Kg 33.9 Lb	
7202/4		98x148 cm 38.6x58.3 in	21,76 Kg 47.9 Lb	
7202/5		98x198 cm 38.6x80 in	29,11 Kg 64.1 Lb	
7202/6	7202/6/M	118x148 cm 46.4x58.3 in	26,2 Kg 57.7 Lb	
7202/7	7202/7/M	118x178 cm 46.4x70 in	31,51 Kg 69.4 Lb	
7202/8	7202/8/M	118x238 cm 46.4x93.7 in	42,13 Kg 92.8 Lb	
7202/9	7202/9/M	118x298 cm 46.4x117.3 in	52,75 Kg 116.2 Lb	

Pizarra de acero vitrificado blanca con esquina redondeada de 10 mm. de grosor sin marco para escritura con rotuladores de borrado en seco. Fabricadas mediante corte de chorro de agua y madera hidrófuga que hace que sus bordes lacados en negro queden con un acabado perfecto. Superficie magnética con garantía de por vida. Disponible en acabado brillo y mate para proyección.

White vitrified steel slate board with 10 mm width rounded corner edges without frame for writing with dry erase markers. Manufactured by water jet cutting and water-repellent wood that give their black lacquered edges a perfect finish. Magnetic surface with lifetime warranty. Available in gloss and matt finish for projection.

Tableau en acier émaillé blanc avec coin arrondi de 10 mm. d'épaisseur, sans cadre pour marqueurs effaçables à sec. Fabriqué en bois hydrofuge et découpé au jet d'eau ce qui lui confère des bords laqués noirs d'une finition parfaite. Surface magnétique garantie à vie. Disponible en finition brillante et mate pour la projection.

Lavagna in acciaio vetrificato bianco con bordi angolari arrotondati di 10 mm di larghezza, senza cornice, per scrivere con pennarelli cancellabili a secco. Realizzata con taglio a getto d'acqua e legno idrorepellente che conferisce ai bordi laccati bianchi una finitura perfetta. Superficie magnetica con garanzia a vita. Disponibile con finitura lucida e opaca per la proiezione.



Chameleon Print



Pizarra con superficie de acero vitrificado blanca que permite mediante sublimación, imprimir la retícula o la foto deseada. Gracias a que no lleva ningún tipo de marco y que su perfecto corte está realizado con chorro de agua y madera hidrófuga, hace que permita cortarse con la silueta deseada. Su superficie magnética permite adaptar imanes.

Blackboard with a white vitrified steel surface that allows, through sublimation, to print the desired grid or photo. Due to it not having any type of frame and that its perfect cut is made using a water jet and water-repellent wood, it allows cutting the desired silhouette. Its magnetic surface allows you to adapt magnets.

Tableau noir avec surface en acier blanc émaillé qui permet par sublimation, imprimer la grille/planning ou la photo souhaitée. Grâce au fait qu'il n'a pas d'encadrement et que sa coupe parfaite est réalisée avec jet d'eau et bois hydrofuge, cela permet d'être coupé avec la silhouette souhaitée. Sa surface magnétique permet d'utiliser les aimants.

Lavagna con superficie in acciaio vetrificato bianco che permette, tramite isolamento, di stampare la griglia o la foto desiderata. Grazie al fatto che non ha alcun tipo di cornice e che il suo taglio perfetto è realizzato con un getto d'acqua e legno idrorepellente, permette di tagliare la sagoma desiderata. La sua superficie magnetica permette di adattare i magneti.

Medidas / Sizes

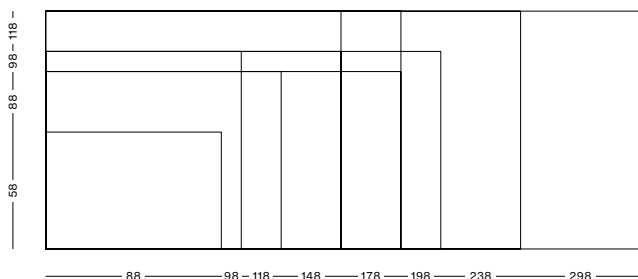

Especificaciones / Specifications



Sin marco / No frame



PARED / WALL

PIZARRA BLANCA / WHITEBOARD



CUSTOM

AV

MATT



1 cm

100% Custom

7200/P2/B

7200/P2/M

Máx. 118x298 cm

0.4 in

Max. 46.4x117.3 in

Impresión personalizable / Customizable print



Glass Board

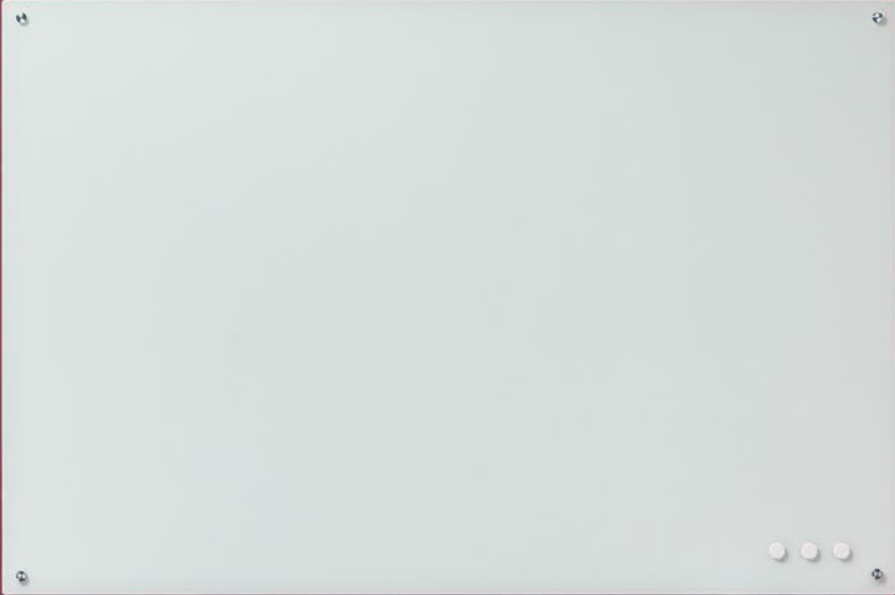

Pizarra magnética de cristal laminado blanco de 4 mm. de grosor sin marco. Superficie apta para rotuladores de borrado en seco. Incorpora elementos de fijación a pared, cajetín de 30 cm reposa rotuladores, 5 imanes de neodimio y un borrador magnético.

4mm wide frameless white laminated glass magnetic whiteboard. Surface suitable for dry erase markers. It incorporates elements for wall mounting, a 30 cm tray for markers, 5 neodymium magnets and a magnetic eraser.

Tableau blanc magnétique en verre stratifié blanc sans cadre de 4 mm. d'épaisseur. Surface adaptée aux marqueurs effaçables à sec. Inclus kit de fixation mural, un auget de 30 cm pour marqueurs, 5 aimants néodyme et un effaceur magnétique.

Lavagna magnetica in vetro laminato bianco traslucido senza cornice di 4 mm di larghezza. Superficie adatta a pennarelli cancellabili a secco. Incorpora elementi per il montaggio a parete, una scatola di 30 cm che contiene i pennarelli, 5 magneti al neodimio e un cancellino magnetico.



Medidas / Sizes

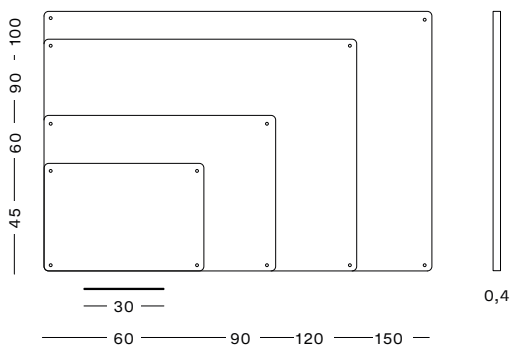

Especificaciones / Specifications



Sin marco / No frame



PARED / WALL



PIZARRA BLANCA / WHITEBOARD



REF	↕ ↔	👤	0,4 cm 0.1 in
728/1	45x60 cm 17,7x23,6 in	8 Kg 17.6 Lb	
728/2	60x90 cm 23,6x35,4 in	13 Kg 28.6 Lb	
728/3	90x120 cm 35,4x47,2 in	19 Kg 41.9 Lb	
728/4	100x150 cm 39,3x59 in	25 Kg 55.1 Lb	

Coloured Glass Board



Pizarra magnética de cristal laminado de 4mm + 1mm de chapa, en colores suaves que mejoran la nitidez en la escritura y el borrado. Superficie apta para escritura y borrado con rotuladores de borrado en seco. Permite adaptar imanes e incluyen los elementos de fijación.

4mm magnetic glass board + 1mm sheet, in soft colours that improve sharpness when writing and erasing. Surface suitable for writing and erasing with dry erase markers. It allows you to adapt and use magnets and includes fittings elements.

Tableau en verre stratifié magnétique de 4mm + 1mm en tôle, disponible dans des couleurs tamisées qui améliorent la netteté de l'écriture et facilitent l'effacement. Surface adaptée à l'écriture avec des marqueurs effaçables à sec. Il permet l'usage d'aimants et comprend les éléments de fixation.

Lavagna magnetica in metallo da 3 mm + 1 mm di larghezza, con colori tenui che migliorano la nitidezza della scrittura e della cancellazione. Superficie adatta per scrivere e cancellare con pennarelli a secco. Permette di adattare i magneti e include elementi di fissaggio.



Coloured Glass Board

Medidas / Sizes

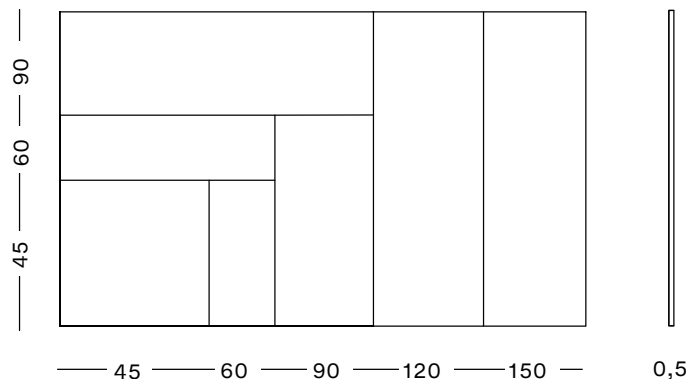

Color / Colour

/BL

RAL 9003

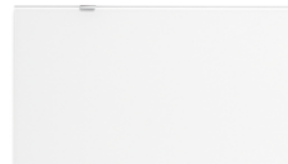

/AM

RAL 1023



/AZ

RAL 6027



/NJ

RAL 1033



/RS

RAL 3015



/VD

RAL 6019



Especificaciones / Specifications



PARED / WALL

CRISTAL / GLASS



REF	/BL	/AM	/AZ	/NJ	/RS	/VD	↕ ↔	📐	0,5 cm 0.1 in
728/CO/1	/BL	/AM	/AZ	/NJ	/RS	/VD	45x45 cm 17.7x17.7 in	6 Kg 13,2 Lb	
728/CO/2	/BL	/AM	/AZ	/NJ	/RS	/VD	45x60 cm 17.7x23.6 in	8 Kg 17,6 Lb	
728/CO/3	/BL	/AM	/AZ	/NJ	/RS	/VD	45x90 cm 17.7x35.4 in	12 Kg 26,4 Lb	
728/CO/4	/BL	/AM	/AZ	/NJ	/RS	/VD	60x60 cm 23.6x23.6 in	10,6 Kg 23,3 Lb	
728/CO/5	/BL	/AM	/AZ	/NJ	/RS	/VD	60x90 cm 23.6x35.4 in	16 Kg 35,2 Lb	
728/CO/6	/BL	/AM	/AZ	/NJ	/RS	/VD	90x90 cm 35.4x35.4 in	24 Kg 52,9 Lb	
728/CO/7	/BL	/AM	/AZ	/NJ	/RS	/VD	90x120 cm 35.4x47.2 in	32 Kg 70,5 Lb	
728/CO/8	/BL	/AM	/AZ	/NJ	/RS	/VD	90x150 cm 35.4x59 in	40 Kg 88,1 Lb	

Accesorios / Accessories

Pack 5 imanes de neodimio (2,5 cm)
 Neodymium 5 magnets pack (9,8 in)
 Pack de 5 aimants néodyme (2,5 cm)
 Confezione da 5 magneti al neodimio (9,8")

9016



Borrador magnético pizarra de cristal
 Glass Board Magnetic Eraser
 Gomme magnétique tableau en verre
 Gomma magnetica per lavagne di vetro

7016



Bandeja de 20cm adhesiva
 Adhesive Pen Tray 20cm
 Auget adhésif 20 cm
 Vassoio portapenna adesivo 20 cm

7280





$8 \times 4 = 32$
 $8 \times 5 = 40$
 $8 \times 6 = 48$
 $8 \times 7 = 56$
 $8 \times 8 = 64$

$S_3 = \begin{bmatrix} 101 \\ 101 \\ 101 \\ 101 \end{bmatrix}$

$(a+b)^2$
 $\tan(2\alpha) = \frac{\tan(\alpha)}{1 - \tan^2(\alpha)}$

$a^2 + b^2 = c^2 - 2bc \cos \alpha$
 $\sin^2 x + \cos^2 x = 1$
 $\frac{a^n}{B^n} = \frac{a^n}{B^n}$

$2x^2 + y^2 = 2$
 $\cos 2x = \cos^2 x - \sin^2 x$

$\int_{-\infty}^{\infty} \frac{dx}{\sqrt{x^2+1}} = 1$
 $\sum_{k=1}^n \frac{1}{k^2} = \frac{\pi^2}{6}$
 $x^2 + (y^2 - \sqrt{x^2})^2 = 1$

$\pi = 3.141592$
 $\frac{dA}{dx} = \frac{dA}{dx}$

75%
 $\int_{-\infty}^{\infty} \frac{dx}{x}$

$\frac{b^2}{c} = c \cdot \frac{b}{c}$
 $\frac{a^2}{c} = c \cdot \frac{a}{c}$



Chameleon Glass

Gama de pizarras de cristal de gran formato para escritura con rotuladores de borrado en seco. Disponibles en 18 colores, en tonos suaves para asegurar la visibilidad durante su escritura. Cristal de seguridad de 4 mm de espesor. Es ideal para empalmar pizarras y formar en la pared la medida deseada.

Large-format glass whiteboard range for use with dry-erase markers. Available in 18 colors, featuring soft tones to ensure visibility during writing. 4mm thick safety glass. Ideal for joining boards and forming the desired size on the wall.

Gamme de tableaux en verre grand format pour écriture avec des marqueurs effaçables à sec. Disponibles en 18 couleurs, avec des tons doux assurant une visibilité pendant l'écriture. Verre de sécurité de 4 mm d'épaisseur. Idéal pour joindre les tableaux et former la taille souhaitée sur le mur.

Gamma di lavagne in vetro di grandi dimensioni per scrivere con pennarelli cancellabili a secco. Disponibili in 18 colori, con tonalità delicate per garantire la visibilità durante la scrittura. Vetro di sicurezza spesso 4 mm. Ideali per unire lavagne e creare la misura desiderata sulla parete.

Especificaciones / Specifications

PARED / WALL

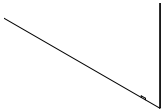

→ ←
0,4 cm
0.15 in



Colores / Colours



G100
AZB



G101
AZS



G102
AZF



G109
MAW



G110
MAC

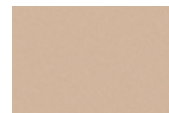

G111
MAT



G103
GRS



G104
GRU

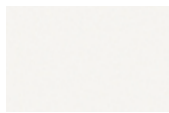

G105
TRA



G112
AMO



G113
AMB

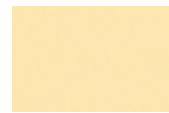

G114
AMV



G106
VDT



G107
VDG



G108
VDJ



G115
RSR



G116
RSB



G117
RSH

Chameleon Glass

CRISTAL / GLASS

REF

7700/10



/AZB



/AZS



/AZF



/MAW



/MAC



/MAT



/GRS



/GRU



/TRA



/AMO



/AMB



/AMV



/VDT



/VDG



/VDJ



/RSR



/RSB



/RSH



98 x 98 cm
38,58 x 38,58 in



15,70 kg
34,61 Lb



REF

7700/15



/AZB



/AZS



/AZF



/MAW



/MAC



/MAT



/GRS



/GRU



/TRA



/AMO



/AMB



/AMV



/VDT



/VDG



/VDJ



/RSR



/RSB



/RSH



98 x 148 cm
38,58 x 58,26 in



22,45 kg
46,50 Lb



CRISTAL / GLASS

REF
7700/20 /AZB /AZS /AZF /MAW /MAC /MAT /GRS /GRU /TRA /AMO /AMB /AMV /VDT /VDG /VDJ /RSR /RSB /RSH

↕ ↔
98 x 198 cm
38,58 x 77,95 in

👤
31,40 kg
69,22 Lb



Medidas / Sizes

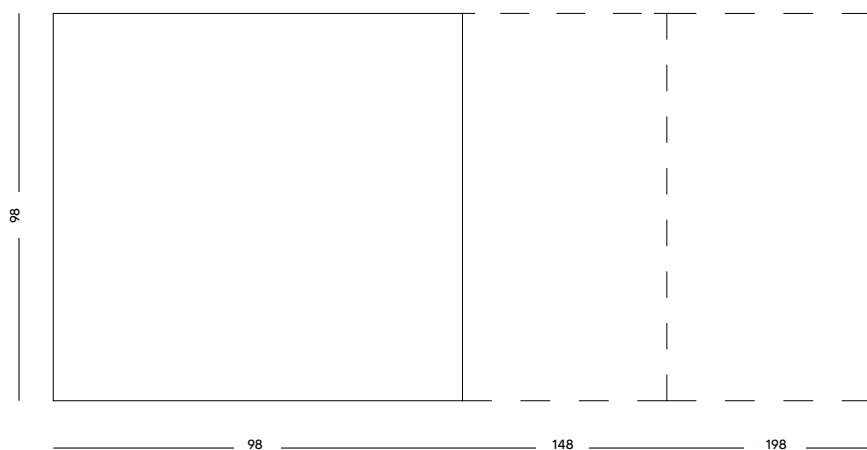

Flipcharts



Pizarras blancas lacadas de caballete para escritura con rotuladores de borrado en seco. Superficies magnéticas aptas para imanes. Estructura metálica con trípode o base con ruedas en cada caso. Incluyen cajetín reposa rotuladores y pinza portablock de papel. La ref. 709/N incluye dos brazos para triplicar la superficie de exposición.

Lacquered easel whiteboards for writing with dry erase markers. Magnetic surfaces suitable for magnets. Metal structure with tripod or base with castors in each version. They include a box to hold markers and a paper block holder. The ref. 709 / N includes two arms to triple the exposure area.

Tableaux chevalets laqués blancs pour marqueurs effaçables à sec. Surfaces magnétiques adaptées aux aimants. Structure métallique avec trépied ou base avec roues. Comprend un auget pour marqueurs et un support de bloc de papier. La réf. 709 / N comprend deux bras extensibles pour tripler la superficie d'exposition.

Lavagne a cavalletto laccate per scrivere con pennarelli cancellabili a secco. Superfici magnetiche adatte a calamite. Struttura in metallo con treppiede o base con rotelle in ogni versione. Includono una scatola per contenere i pennarelli e un portablocco di carta. Il modello ref. 709/N include due bracci per triplicare l'area di esposizione.

Medidas / Sizes

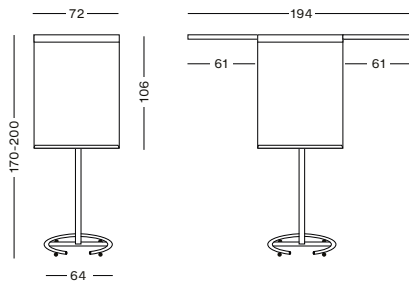

Medidas / Sizes

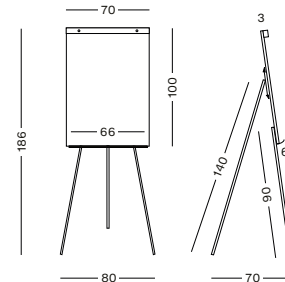

Especificaciones / Specifications



PIZARRA BLANCA / WHITEBOARD 

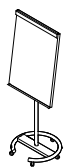

REF	↕ ↔		64 cm
709/N	MAX. 200/170x72 cm MAX. 78.7/66.9x28.3 in	18 Kg 39.6 Lb	25.2 in

Especificaciones / Specifications



PIZARRA BLANCA / WHITEBOARD 



REF	↕ ↔		70 cm
711/N	168x80 cm 66.1x31.5 in	10 Kg 22.6 Lb	27.5 in

Screen board



Mampara pizarra separadora para puestos de trabajo de acero vitrificado. Superficie para escritura con rotuladores de borrado en seco, magnética para uso de imanes y en la parte posterior incorpora de la misma medida que la pizarra un panel fonoabsorbente de PET reciclado de color gris. Permite sujeción de notas mediante chinchetas. El conjunto se fija mediante juego de pinzas incluidas.

Slate board partition screen for workstations in vitrified steel. Surface for writing with dry erase markers, magnetic for use of magnets and on the back it incorporates, in the same measure as the blackboard, a sound absorbing panel made of recycled PET in grey. It allows placement of notes with thumbtacks. The set is fixed using a set of brackets included.

Cloison séparatrice pour poste de travail en acier émaillé. Une face d'écriture pour marqueurs effaçables à sec et magnétique pour l'utilisation d'aimants et au dos un panneau insonorisant en PET recyclé de couleur gris. Permet l'affichage de notes. L'ensemble est fixé à l'aide d'un jeu de pinces incluses.

Schermo divisorio in ardesia per postazioni di lavoro in acciaio vetrificato. Superficie per scrivere con pennarelli cancellabili a secco, magnetica per l'utilizzo di calamite e sul retro incorpora, nella stessa misura della lavagna, un pannello fonoassorbente in PET riciclato di colore grigio. Consente il posizionamento di appunti con puntine da disegno. Il set si fissa con una serie di staffe incluse.

Medidas / Sizes

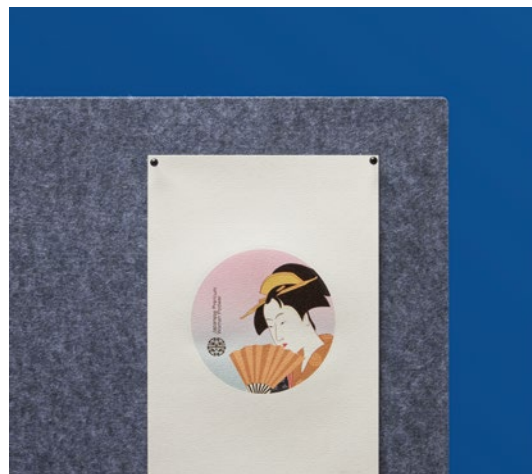
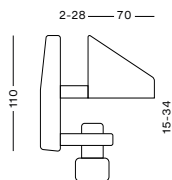
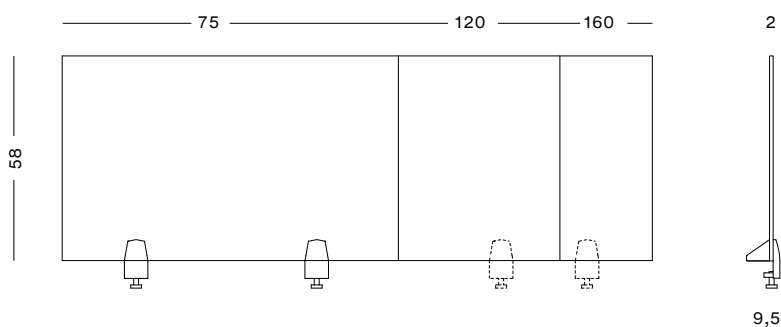

Especificaciones / Specifications

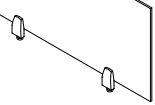

	PIZARRA BLANCA / WHITEBOARD	↔	↔	
	REF	↕ ↔	📏	2 cm
	EP/MP/58/75	58x75 cm 22.8x29.5 in	📏	9,7 Kg 21.4 Lb
	EP/MP/58/120	58x120 cm 22.8x47.2 in	📏	12,7 Kg 28 Lb
	EP/MP/58/160	58x160 cm 22.8x62.9 in	📏	16,5 Kg 36.4 Lb



Soportes



Juego de soportes con ruedas para toda la gama de pizarras y tableros de anuncios. Fabricados en 2 calidades, de hierro y aluminio, y disponibles en plata mate, y lacados en antracita y blanco. También dispone de pies en forma de T de madera. Todos los soportes incluyen 4 ruedas giratorias 2 de ellas provistas de freno. La base Y2 es de fundición de aluminio.

Set of brackets with castors for the entire range of whiteboards and bulletin boards. Made in two versions, metal and aluminium, and available in matt silver, and lacquered in anthracite and white. Wooden T-shaped feet are also available. All supports include 4 swivel castors 2 of them with brakes. The Y2 base is made of cast aluminium.

Ensemble de supports à roulettes pour toute la gamme de tableaux blancs et d'affichage. Fabriqué en 2 finitions, métal et aluminium, disponible en argent mat, laqué anthracite ou blanc. Les pieds "T" sont également disponibles en bois. Tous les supports comprennent 4 roues pivotantes, dont 2 équipés de freins. La base Y2 est en fonte d'aluminium.

Ensemble de supports à roulettes pour toute la gamme de tableaux blancs et d'affichage. Fabriqué en 2 finitions, métal et aluminium, disponible en argent mat, laqué anthracite ou blanc. Les pieds "T" sont également disponibles en bois. Tous les supports comprennent 4 roues pivotantes, dont 2 équipés de freins. La base Y2 est en fonte d'aluminium.

Medidas / Sizes

MADERA / WOOD

METAL

ALUMINIO / ALUMINIUM

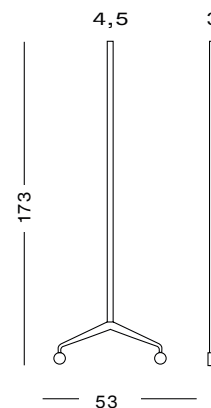
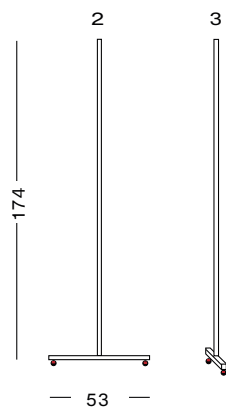
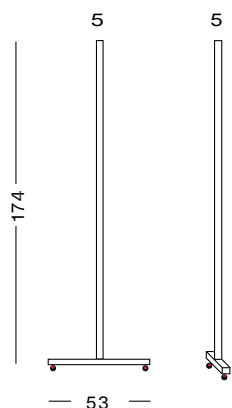

Especificaciones / Specifications



Disponible para / Available for

720 + 725

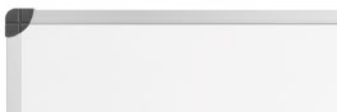

730 + 730/A



765



760



Z/720



Z/730



Z/765

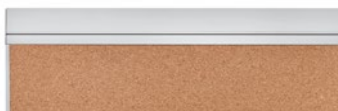

Z/760



724

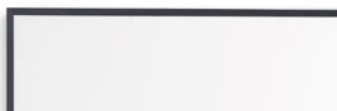

Soportes

Metal · Soporte T · Color / Metal · T support · Colour

Madera / Wood

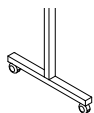

REF
770/1



/GR



/AN



/BL

↕ ↔
174x53 cm
68.5x20.8 in



7 Kg
15.4 Lb

53 cm
68.5 in

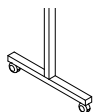

REF
770/1



/WO

↕ ↔
174x53 cm
68.5x20.8 in



7 Kg
15.4 Lb

Tableros compatibles / Compatible boards

PIZARRA BLANCA / FOR WHITEBOARD

PIZARRA DE TIZA / FOR CHALKBOARD

TABLERO DE ANUNCIOS / FOR PINBOARD

COLOR TABLERO DE ANUNCIOS /
COLOUR FOR PINBOARD

Slim Board



Classic Board



Metal · Soporte Y2 · Color / Metal · Y2 support · Colour

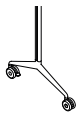

REF	●	●	○	↕ ↔	👤
Y2/80	/R	/AN	/BL	173x80 cm 68.1x31.4 in	5 Kg 11 Lb
Y2/120	/R	/AN	/BL	173x120 cm 68.1x47.2 in	6 Kg 13.2 Lb
Y2/150	/R	/AN	/BL	173x150 cm 68.1x6.5 in	6,5 Kg 14.3 Lb
Y2/175	/R	/AN	/BL	173x175 cm 68.1x68.8 in	7 Kg 15.4 Lb
Y2/200	/R	/AN	/BL	173x200 cm 68.1x78.7 in	7,5 Kg 16.5 Lb

53 cm
68.5 in

Tableros compatibles / Compatible boards

PIZARRA BLANCA / FOR WHITEBOARD

PIZARRA DE TIZA / FOR CHALKBOARD

TABLERO DE ANUNCIOS / FOR PINBOARD

COLOR PARA TABLERO DE ANUNCIOS /
COLOUR FOR PINBOARD

Slim Board



Classic Board



Zenit Board



Accesorios

Borrador magnético "Design"
Magnetic eraser "Design"
Effaceur magnetique "Design"
Cancellino magnetico "Design"

7015



Recambio para borrador 7015
7015 eraser felt refills
Feutrinés pour effaceur 7015
7015 ricariche di feltro per cancellare

7015/1

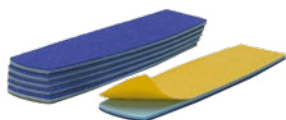

5 u.

Rotuladores de pizarra
Whiteboard markers
Marqueurs effaçables à sec
Pennarelli per lavagne bianche

7005
7005/12



4 u. - 10 u.

Portarrotuladores magnéticos
Magnetics marker holder
Porte marqueurs magnétique
Supporto per pennarello magnetico

7019



Borrador de plástico
Plastic eraser
Effaceur en plastique
Cancellino in plastica

7014



Recambio para borrador 7014
7014 eraser felt refills
Feutrinés pour effaceur 7014
7014 ricariche di feltro per cancellare

7014/1

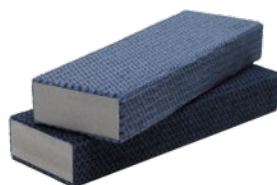

2 u.

Aerosol para pizarras (200 ml)
Whiteboard cleaner spray (200 ml)
Spray nettoyant (200 ml)
Spray detergente lavagne bianche (200 ml)

7008



4 Markers. Cleaning liquid 50 ml.
OVAL magnetic eraser. Eraser replacement
felts. Pack of 10 magnets ø20mm.

KIT/E



Borrador magnético
Magnetic eraser
Effaceur magnetique
Cancellino magnetico

7006



Borrador
Eraser
Effaceur
Cancellino

7012



Recambio para borrador 7006 y 7012
7006 and 7012 eraser felt refills
Feutrinés pour effaceur 7006 et 7012
Ricariche di feltro per gomma 7006 e 7012

7006/1

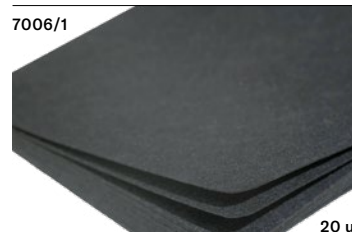

20 u.

4 Markers. Cleaning liquid 200 ml.
Magnetic eraser. Eraser replacement
felts. Pack 10 magnets ø20 mm.
Magnetic marker rest.

KIT/T



Bloc de papel liso 90 x 60 cm
Pad of plain paper 90 x 60 cm
Recharge papier uni 90 x 60 cm
Blocco di carta comune 90 x 60 cm

7001



25 sheets

Cajetín de 100, 30 cm
100, 30 cm Pen Tray
Porte-marqueurs de 100, 30 cm
100, 30 cm Vassoio portapenna

7003
7003/30



Pack 5 imanes de neodimio (2,5 cm)
Neodymium 5 magnets pack (9.8 in)
Pack de 5 aimants néodyme (2,5 cm)
Confezione da 5 magneti al neodimio (9,8")

9016



Caja tizas blancas
White chalk box
Boîte de craies blanches
Scatola di gesso bianco

7013/B
(10 Uts.)



Pinza portablock 7 x 69 cm
Pad holder 7 x 69 cm
Pince papier 7 x 69 cm
Supporto per pad 7 x 69 cm

7002



Imanes redondos ø2, ø2.5, ø3.2 cm
Round magnets ø2, ø2.5, ø3.2 cm
Aimants ronds ø2, ø2.5, ø3.2 cm
Magnetni rotondi ø2, ø2.5, ø3.2 cm

9002
9003
9004



6 u.

Borrador magnético pizarra de cristal
Glass Board Magnetic Eraser
Gomme magnétique tableau en verre
Gomma magnetica per lavagne di vetro

7016



Caja tizas de colores
Colored chalk box
Boîte de craies colorée
Scatola di gesso colorato

7013/C
(10 Uts.)



Pinza portablock magnética 6 x 65 cm
Magnetic pad holder 6 x 65 cm
Pince papier magnétique 6 x 65 cm
Portablocco magnetico 6 x 65 cm

7002/M



Imanes redondos ø0,9 cm
Round magnets ø0,9 cm
Aimants ronds ø0,9 cm
Magnetni rotondi ø0,9 cm

9010



20 u.

Bandeja de 20cm adhesiva
Adhesive Pen Tray 20cm
Auget adhésif 20 cm
Vassoio portapenna adesivo 20 cm

7280



Pinboards

Slim Pinboard - Tablero de anuncios de perfil fino	88
Classic Pinboard - Tablero de anuncios Classic	94
R·PET Pinboard - Tablero de anuncios de Perfil Reciclado	98
Zenit Pinboard - Tablero de anuncios Zenit	102
Basic Pinboard - Tablero de anuncios Basic	106
Pinboards Showcase - Vitrina de anuncios	108
Basic Showcase - Vitrina Basic	112
Outdoor Showcase - Vitrina para exteriores	114
Outdoor Telescopic Showcase - Vitrina para exteriores telescópica	116



Tener a la vista tus notas, fotos, dibujos o tus textos preferidos hace que su soporte sea cuanto menos, igual de importante. Ese recordatorio visual, esa tarea pendiente, aquel instante captado por una cámara en forma de foto, o ese dibujo de tu hijo que te hace sentir especial, merece un buen espacio, y en la empresa o en la escuela, un informe, una notificación, unas notas académicas, o el póster de algún evento necesitan de su espacio en una zona visual al abasto de todas las miradas. Con o sin acristalar y por supuesto en tu color preferido o en el que tu equipo de interioristas decida cual queda mejor en el espacio donde se vaya a ubicar.

Avoir vos notes, photos, dessins ou vos textes préférés à la vue rend leur support d'autant plus important. Ce rappel visuel, cette tâche en attente, ce moment capturé par un appareil photo, ou ce dessin de votre enfant qui vous fait vous sentir spécial mérite un bon espace, et dans l'entreprise ou à l'école, un rapport, une notification, des notes académiques ou l'affiche d'un événement ont aussi besoin d'une place dans un espace visuel et ainsi ravir tous les regards. Avec ou sans vitrage et bien sûr de la couleur de votre choix ou de celle de votre équipe d'architectes d'intérieur il saura s'adapter à votre espace.

Having your notes, photos, drawings or your favorite texts on view makes the drawing board just as important. That visual reminder, that pending task, that moment captured by a camera in the form of a photo, or that drawing of your child who makes you feel special deserves a good place, at work or at school, a report, a notification, academic notes, or the poster of an event need a place in a visual area for all eyes to see. With or without glazing and of course in your favorite colour or wherever your team of interior designers decides is the best option for the place where it's to be located.

Avere in bella mostra gli appunti, le foto, i disegni o i testi preferiti rende il loro supporto almeno altrettanto importante. Quel promemoria visivo, quel compito in sospeso, quell'istante catturato da una macchina fotografica sotto forma di foto, o quel disegno di vostro figlio che vi fa sentire speciali, meritano un buon spazio, We in azienda o a scuola, una relazione, una notifica, qualche nota accademica o la locandina di un evento hanno bisogno del loro spazio in un'area visiva disponibile a tutti gli occhi. Con o senza vetri e, naturalmente, nel vostro colore preferito o in quello che il vostro team di designer d'interni deciderà essere il più adatto allo spazio in cui deve essere collocato.

Slim Pinboard



Tablero de anuncios tapizado o corcho visto natural, enmarcado con perfil de aluminio Slim anodizado plata mate o lacado en blanco o antracita. Disponibles para fijarse tanto en la pared, como sobre soportes móviles con ruedas y freno. Sobre su superficie se pueden fijar notas, avisos, comunicados, mediante agujas o chinchetas. Corcho de 5 mm de grosor. Gama de textil a elegir en 12 colores.

Upholstered notice board or natural visible cork, framed with anodized Slim aluminium profile matt silver or lacquered in white or anthracite. Available to fix both on the wall, or mobile on castors with brakes. Notes and notices can be attached to its surface using pins or thumbtacks. 5 mm thick cork. Choice among 12 textile colours.

Tableau d'affichage tapissé ou en liège naturel, encadré d'un profil mince en aluminium anodisé argent mat, laqué blanc ou gris anthracite. Disponible pour le fixer aussi bien au mur que sur des supports mobiles avec roues et frein. Les notes, avis, communiqués etc. Peuvent être fixés sur la surface à l'aide d'aiguilles ou de punaises. Liège de 5 mm d'épaisseur. Tissu à choisir entre 12 coloris.

Bacheca imbottita o in sughero naturale a vista, incorniciata con profilo in alluminio Slim anodizzato argento opaco o laccato bianco o antracite. Disponibile sia con fissaggio a parete che mobile su ruote con freno. Note e avvisi possono essere attaccati alla sua superficie con spilli o puntine. Spessore del sughero 5 mm. Scelta di tessuti in 12 colori.

Medidas / Sizes



Especificaciones / Specifications

Corcho / Cork



Colores textiles / Textiles colours



Slim PinBoard

Marcos de madera / Wood frames



PARED / WALL

CORCHO / CORK

REF	↕ ↔	📏
764/10/C/WO	40x60 cm 15.7x23.6 in	3.10 Kg 6.83 Lb
764/1/C/WO	60x80 cm 23.6x31.5 in	6 Kg 13.22 Lb
764/2/C/WO	80x100 cm 31.5x39.3 in	10 Kg 22.04 Lb
764/3/C/WO	100x120 cm 39.3x47.2 in	13 Kg 28.66 Lb
764/4/C/WO	100x150 cm 39.3x60 in	17 Kg 37.47 Lb
764/5/C/WO	100x175 cm 39.3x70 in	18 Kg 39.68 Lb
764/6/C/WO	100x200 cm 39.3x78.7 in	22 Kg 48.50 Lb

TEXTILES / TEXTILES



REF	COLORES/COLOURS	↕ ↔	📏	3 cm 1.1 in
764/10/WO	● /NG ● /BD	40x60 cm 15.7x23.6 in	3.10 Kg 6.83 Lb	
764/1/WO	● /GR ● /AC	60x80 cm 23.6x31.5 in	6 Kg 13.22 Lb	
764/2/WO	● /CR ● /AZ	80x100 cm 31.5x39.3 in	10 Kg 22.04 Lb	
764/3/WO	● /OC ● /VM	100x120 cm 39.3x47.2 in	13 Kg 28.66 Lb	
764/4/WO	● /NJ ● /VC	100x150 cm 39.3x60 in	17 Kg 37.47 Lb	
764/5/WO	● /RJ ● /VD	100x175 cm 39.3x70 in	18 Kg 39.68 Lb	
764/6/WO		100x200 cm 39.3x78.7 in	22 Kg 48.50 Lb	

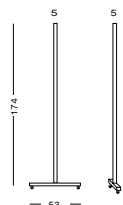

SOPORTE / SUPPORT

MEDIDAS DISPONIBLES / AVAILABLE SIZES



REF	↕ ↔	↕	📏	53 cm 20.9 in
770/1/WO/1	80x100 cm 31.5x39.3 in	174 cm 68.5 in	7 Kg 15.4 Lb	
770/1/WO/2	100x120 cm 39.4x47.2 in			
770/1/WO/3	100x150 cm 39.4x60 in			
770/1/WO/4	100x175 cm 39.4x70 in			
770/1/WO/5	100x200 cm 39.4x78.7 in			

Marcos de aluminio / Aluminium frames

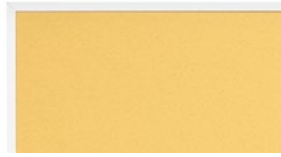
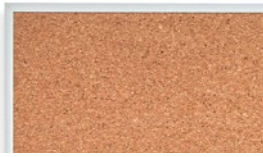

PARED / WALL



CORCHO / CORK



	●	●	○	↕ ↔	⚖	RAIL	T	Y2	2,3 cm 0.9 in
764/10/C	764/10/C/AN	764/10/C/BL	40x60 cm 15.7x23.6 in	3.10 Kg 6.83 Lb					
764/1/C	764/1/C/AN	764/1/C/BL	60x80 cm 23.6x31.5 in	6 Kg 13.22 Lb					
764/2/C	764/2/C/AN	764/2/C/BL	80x100 cm 31.5x39.3 in	10 Kg 22.04 Lb	•	•	•		
764/3/C	764/3/C/AN	764/3/C/BL	100x120 cm 39.3x47.2 in	13 Kg 28.66 Lb	•	•	•		
764/4/C	764/4/C/AN	764/4/C/BL	100x150 cm 39.3x60 in	17 Kg 37.47 Lb	•	•	•		
764/5/C	764/5/C/AN	764/5/C/BL	100x175 cm 39.3x70 in	18 Kg 39.68 Lb	•	•	•		
764/6/C	764/6/C/AN	764/6/C/BL	100x200 cm 39.3x78.7 in	22 Kg 48.50 Lb			•	•	
764/7/C	764/7/C/AN	764/7/C/BL	100x250 cm 39.3x98.4 in	26 Kg 57.32 Lb					

PARED / WALL



TEXTILES / TEXTILES



	●	●	○	COLORES / COLOURS	↕ ↔	⚖	RAIL	T	Y2	2,3 cm 0.9 in
764/10	764/10/AN	764/10/BL	● /NG ● /BD	40x60 cm 15.7x23.6 in	3.10 Kg 6.83 Lb					
764/1	764/1/AN	764/1/BL	● /GR ● /AC	60x80 cm 23.6x31.5 in	6 Kg 13.22 Lb					
764/2	764/2/AN	764/2/BL	● /CR ● /AZ	80x100 cm 31.5x39.3 in	10 Kg 22.04 Lb	•	•	•		
764/3	764/3/AN	764/3/BL	● /OC ● /VM	100x120 cm 39.3x47.2 in	13 Kg 28.66 Lb	•	•	•		
764/4	764/4/AN	764/4/BL	● /NJ ● /VC	100x150 cm 39.3x60 in	17 Kg 37.47 Lb	•	•	•		
764/5	764/5/AN	764/5/BL	● /RJ ● /VD	100x175 cm 39.3x70 in	18 Kg 39.68 Lb	•	•	•		
764/6	764/6/AN	764/6/BL		100x200 cm 39.3x78.7 in	22 Kg 48.50 Lb			•	•	
764/7	764/7/AN	764/7/BL		100x250 cm 39.3x98.4 in	26 Kg 57.32 Lb					

Slim board

Soportes metálicos / Metallic supports



SOPORTE / SUPPORT

MEDIDAS DISPONIBLES / AVAILABLE SIZES

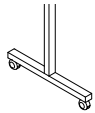

770/1/GR



770/1/AN



770/1/BL



80x100 cm
31.5x39.3 in
100x120 cm
39.3x47.2 in
100x150 cm
39.3x60 in
100x175 cm
39.3x70 in
120x200 cm
47.2x78.7 in



174 cm
68.5 in

7 Kg

15.4 Lb

53 cm
20.9 in



Soportes de aluminio / Aluminium supports



SOPORTE / SUPPORT

MEDIDAS DISPONIBLES / AVAILABLE SIZES



	●	●	○	↕ ↔	↕	📏	
Y2/80/R	Y2/80/R/AN	Y2/80/R/BL	80x100 cm 31.5x39.3 in	173 cm 68.1 in	5 Kg 11 Lb		53 cm 20.9 in
Y2/120/R	Y2/120/R/AN	Y2/120/R/BL	100x120 cm 39.3x47.2 in	173 cm 68.1 in	6 Kg 13.2 Lb		
Y2/150/R	Y2/150/R/AN	Y2/150/R/BL	100x150 cm 39.3x60 in	173 cm 68.1 in	6,5 Kg 14.3 Lb		
Y2/200/R	Y2/200/R/AN	Y2/200/R/BL	120x200 cm 47.2x78.7 in	173 cm 68.1 in	7 Kg 15.4 Lb		
Y2/250/R	Y2/250/R/AN	Y2/250/R/BL	120x250 cm 47.2x96.7 in	173 cm 68.1 in	7,5 Kg 16.5 Lb		



Classic Pinboard

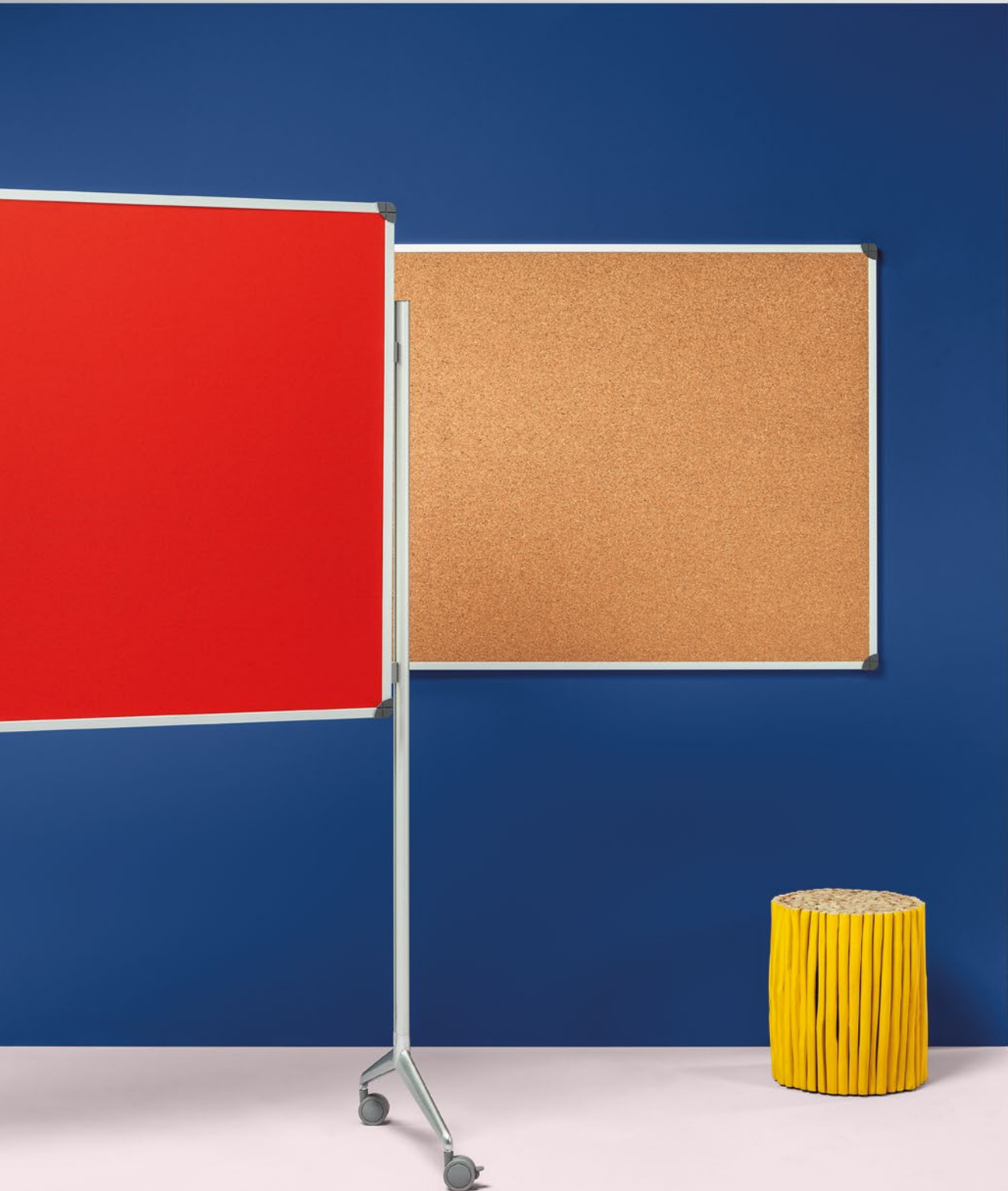

Tablero de anuncios tapizado o corcho visto natural, enmarcado con perfil de aluminio Classic anodizado plata mate y cantoneras de plástico gris en las esquinas para evitar golpes. Disponibles para fijarse tanto en la pared, como sobre soportes móviles con ruedas y freno. Sobre su superficie se pueden fijar notas, avisos, comunicados, mediante agujas o chinchetas. Corcho de 5 mm de grosor. Gama de textil a elegir en 12 colores.

Upholstered notice board or natural visible cork, framed with a matt silver anodized classic aluminium profile and grey plastic corner pieces to avoid bumps. Available to fix both on the wall or mobile supports with castors and brakes. Notes, notices can be attached to its surface using pins or thumbtacks. 5 mm thick cork. Choice among 12 textile colours.

Tableau d'affichage tapissé ou en liège naturel apparent, encadré d'un profil en aluminium Classic anodisé avec angles en plastique gris pour éviter les coups. Disponible pour le fixer aussi bien sur le mur que sur des supports mobiles avec roues et frein. Les notes, avis, communiqués etc. peuvent être fixés sur la surface à l'aide d'aiguilles ou de punaises. Liège de 5 mm d'épaisseur. Tissu à choisir parmi 12 coloris.

Bacheca imbottita o in sughero naturale a vista, incorniciata da un profilo in alluminio classico anodizzato argento opaco e da angolari in plastica grigia per evitare urti. Disponibile per il fissaggio a parete o su supporti mobili con rotelle e freni. Note e avvisi possono essere attaccati alla superficie con spilli o puntine. Spessore del sughero 5 mm. Gamma di tessuti a scelta in 12 colori.

Medidas / Sizes

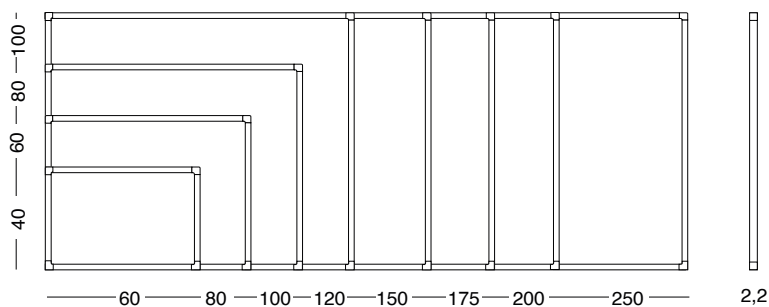

Especificaciones / Specifications

Corcho / Cork



Colores textiles / Textiles colours



/NG /GR /CR /OC /NJ /RJ /BD /AC /AZ /VM /VC /VD



Classic Pinboard

Marcos de aluminio / Aluminium frames



PARED / WALL



CORCHO / CORK



REF	↕ ↔	📏	RAIL	T	Y2		2,2 cm 0.9 in
765/10	40x60 cm 15.7x23.6 in	3.10 Kg 6.83 Lb					
765/1	60x80 cm 23.6x31.5 in	6 Kg 13.22 Lb					
765/2	80x100 cm 31.5x39.3 in	10 Kg 22.04 Lb	•	•	•		
765/3	100x120 cm 39.3x47.2 in	13 Kg 28.66 Lb	•	•	•		
765/4	100x150 cm 39.3x60 in	17 Kg 37.47 Lb	•	•	•		
765/5	100x175 cm 39.3x70 in	18 Kg 39.68 Lb	•	•			
765/6	100x200 cm 39.3x78.7 in	22 Kg 48.50 Lb		•	•		
765/7	100x250 cm 39.3x98.4 in	26 Kg 57.32 Lb			•		

PARED / WALL



TEXTILES / TEXTILES



REF	COLORES / COLOURS	↕ ↔	📏	RAIL	T	Y2		2,2 cm 0.9 in
760/10	● /NG ● /BD	40x60 cm 15.7x23.6 in	3.10 Kg 6.83 Lb					
760/1	● /GR ● /AC	60x80 cm 23.6x31.5 in	6 Kg 13.22 Lb					
760/2	● /CR ● /AZ	80x100 cm 31.5x39.3 in	10 Kg 22.04 Lb	•	•	•		
760/3	● /OC ● /VM	100x120 cm 39.3x47.2 in	13 Kg 28.66 Lb	•	•	•		
760/4	● /NJ ● /VC	100x150 cm 39.3x60 in	17 Kg 37.47 Lb	•	•	•		
760/5	● /RJ ● /VD	100x175 cm 39.3x70 in	18 Kg 39.68 Lb	•	•			
760/6		100x200 cm 39.3x78.7 in	22 Kg 48.50 Lb		•	•		
760/7		100x250 cm 39.3x98.4 in	26 Kg 57.32 Lb			•		

Soportes / Supports



SOPORTE / SUPPORT

MEDIDAS DISPONIBLES / AVAILABLE SIZES

●	●	○	↕ ↔	↕	⚖	↔
770/1	770/1/AN	770/1/BL	80x100 cm 31.5x39.3 in	174 cm 68.5 in	7 Kg 15.4 Lb	53 cm 68.5 in
			100x120 cm 39.3x47.2 in			
			100x150 cm 39.3x60 in			
			100x175 cm 39.3x70 in			
			120x200 cm 47.2x78.7 in			



SOPORTE / SUPPORT

MEDIDAS DISPONIBLES / AVAILABLE SIZES



●	●	○	↕ ↔	↕	⚖	↔
Y2/80/R	Y2/80/R/AN	Y2/80/R/BL	80x100 cm 31.5x39.3 in	173 cm 68.1 in	5 Kg 11 Lb	53 cm 68.5 in
Y2/120/R	Y2/120/R/AN	Y2/120/R/BL	100x120 cm 39.3x47.2 in		6 Kg 13.2 Lb	
Y2/150/R	Y2/150/R/AN	Y2/150/R/BL	100x150 cm 39.3x60 in		6,5 Kg 14.3 Lb	
Y2/200/R	Y2/200/R/AN	Y2/200/R/BL	120x200 cm 47.2x78.7 in		7 Kg 15.4 Lb	
Y2/250/R	Y2/250/R/AN	Y2/250/R/BL	120x250 cm 47.2x96.7 in		7,5 Kg 16.5 Lb	

MÁS DETALLES SOBRE EL SOPORTE / MORE DETAILS ABOUT THE SUPPORT

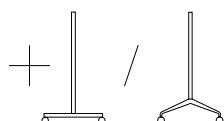

R · PET Pinboard



Tablero de anuncios mural tapizado o corcho visto natural, fabricado con perfil extrusionado y cantoneras inyectadas de plástico reciclado R-Pet Classic de color gris. El PET que usamos en los tableros proviene de botellas y envases 100% reciclados con el fin de mejorar la sostenibilidad del planeta invirtiendo en unos nuevos productos de larga vida útil. Sobre su superficie se pueden fijar notas, avisos, comunicados, mediante agujas o chinchetas. Corcho de 5 mm de grosor. Gama de textil a elegir en 12 colores.

Upholstered wall notice board or natural visible cork, made with extruded profile and injected corner pieces of R-Pet Classic recycled plastic in grey. The PET we use in the boards comes from 100% recycled bottles and containers in order to improve the sustainability of the planet by investing in new long-life products. Notes, notices can be attached to its surface using pins or thumbtacks. 5 mm thick cork. Choice among 12 textile colours.

Tableau d'affichage mural tapissé ou en liège naturel, fabriqué avec un profil extrudé et des coins injectés en plastique recyclé R-Pet Classic gris. Le PET que nous utilisons pour nos tableaux provient de bouteilles et de conteneurs en plastique 100% recyclés, en investissant dans de nouveaux produits longue durée, nous contribuons à améliorer la durabilité de notre planète. Les notes, avis, communiqués etc. peuvent être fixés sur la surface à l'aide d'aiguilles ou de punaises. Liège de 5 mm d'épaisseur. Tissu à choisir parmi 12 coloris.

Bachecca da parete imbottita o in sughero naturale a vista, realizzata con profilo estruso e angolari iniettati in plastica riciclata R-Pet Classic di colore grigio. Il PET che utilizziamo nelle bacheche proviene al 100% da bottiglie e contenitori riciclati, per migliorare la sostenibilità del pianeta investendo in nuovi prodotti a lunga durata. Note e avvisi possono essere attaccati alla superficie con spilli o puntine. Spessore del sughero 5 mm. Gamma di tessuti a scelta in 12 colori.

Medidas / Sizes

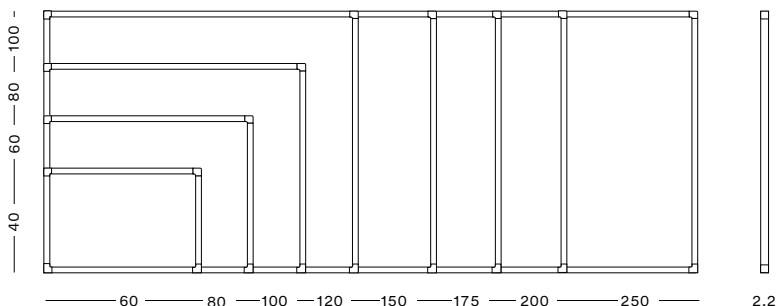

Especificaciones / Specifications

Corcho / Cork



Colores textiles / Textiles colours



/NG /GR /CR /OC /NJ /RJ /BD /AC /AZ /VM /VC /VD



R · PET Pinboard

Marco R·PET / R·PET frames

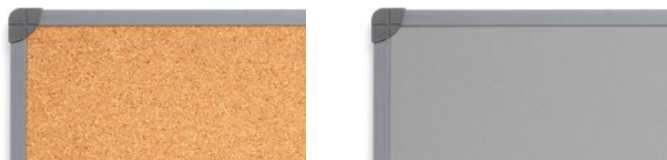

PARED / WALL



CORCHO / CORK

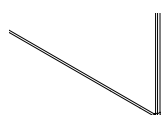

REF	COLORES / COLOURS	↕ ↔	📏
765/10/REC		40x60 cm 15.7x23.6 in	3.10 Kg 6.83 Lb
765/1/REC		60x80 cm 23.6x31.5 in	6 Kg 13.22 Lb
765/2/REC		80x100 cm 31.5x39.3 in	10 Kg 22.04 Lb
765/3/REC		100x120 cm 39.3x47.2 in	13 Kg 28.66 Lb
765/4/REC		100x150 cm 39.3x60 in	17 Kg 37.47 Lb
765/5/REC		100x175 cm 39.3x70 in	18 Kg 39.68 Lb
765/6/REC		100x200 cm 39.3x78.7 in	22 Kg 48.50 Lb
765/7/REC		100x250 cm 39.3x98.4 in	26 Kg 57.32 Lb

2,2 cm
0.9 in

PARED / WALL



TEXTILES / TEXTILES

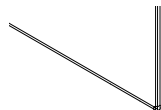

REF	COLORES / COLOURS	↕ ↔	📏
760/10/REC	● /NG ● /BD	40x60 cm 15.7x23.6 in	3.10 Kg 6.83 Lb
760/1/REC	● /GR ● /AC	60x80 cm 23.6x31.5 in	6 Kg 13.22 Lb
760/2/REC	● /CR ● /AZ	80x100 cm 31.5x39.3 in	10 Kg 22.04 Lb
760/3/REC	● /OC ● /VM	100x120 cm 39.3x47.2 in	13 Kg 28.66 Lb
760/4/REC	● /NJ ● /VC	100x150 cm 39.3x60 in	17 Kg 37.47 Lb
760/5/REC	● /RJ ● /VD	100x175 cm 39.3x70 in	18 Kg 39.68 Lb
760/6/REC		100x200 cm 39.3x78.7 in	22 Kg 48.50 Lb
760/7/REC		100x250 cm 39.3x98.4 in	26 Kg 57.32 Lb

2,2 cm
0.9 in

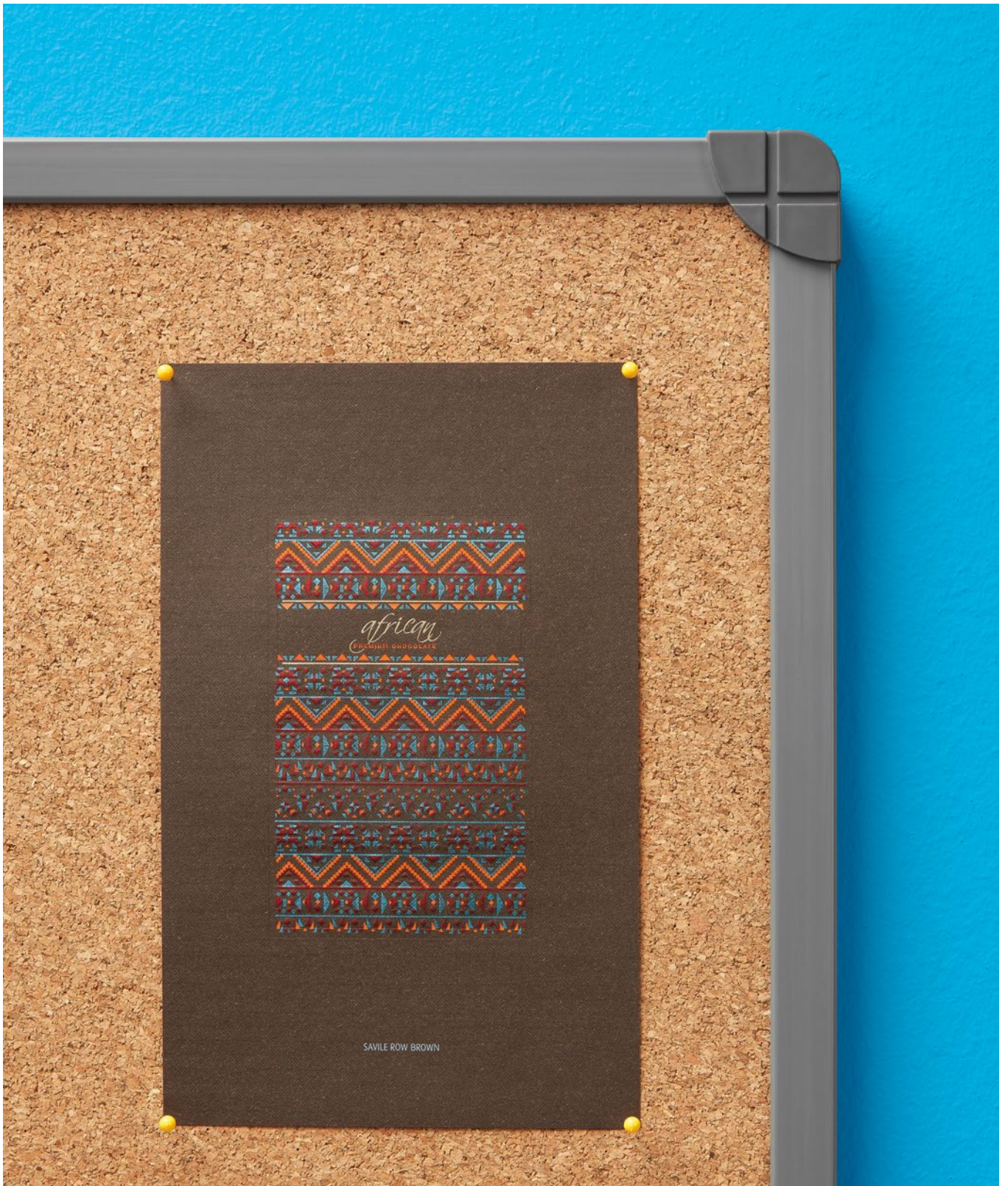

Zenit Pinboard



Tablero mural Zenit tapizado o corcho visto natural, enmarcado de perfil de aluminio con anclajes ocultos anodizado en color plata mate. Disponibles para fijarse tanto en la pared, como sobre soportes móviles con ruedas y freno. Sobre su superficie se pueden fijar notas, avisos, comunicados, etc... Mediante agujas o chinchetas. Corcho de 5 mm de grosor. Gama de textil a elegir en 12 colores.

Zenit wall notice boards upholstered or natural visible cork, framed in aluminium profile with hidden anchors anodized matt silver. Available to fix both to the wall or to mobile supports with castors with brake mechanism. Notes, notices, etc. Can be attached to its surface using pins or thumbtacks. 5 mm thick cork. Choice among 12 textile colours.

Tableau mural Zenit tapissé ou en liège naturel, encadré d'un profilé en aluminium anodisé de couleur argent mat, fixation invisible. Disponible pour le fixer aussi bien sur le mur, que sur des supports mobiles avec roues et freins. Les notes, avis, circulaires etc. peuvent être attachés à sa surface à l'aide d'aiguilles ou de punaises. Liège de 5 mm d'épaisseur. Choix du tissu parmi 12 coloris.

Bacheche da parete Zenit imbottite o in sughero naturale a vista, incorniciate in profilo di alluminio con ancoraggi nascosti anodizzati argento opaco. Disponibili per il fissaggio a parete o su supporti mobili con ruote con meccanismo di freno. Note, avvisi, ecc... Possono essere attaccati alla sua superficie con puntine o puntine da disegno. Spessore del sughero 5 mm. Scelta di 12 colori tessili.

Medidas / Sizes

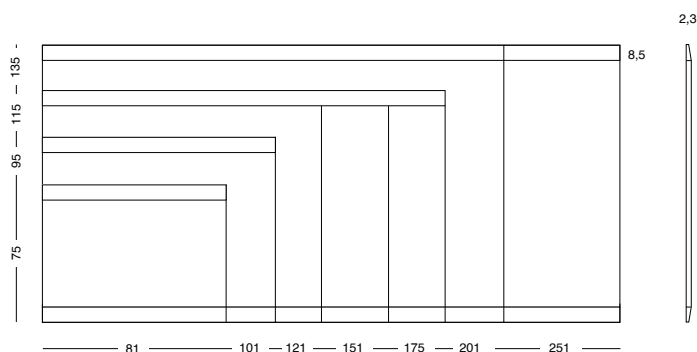

Especificaciones / Specifications

Corcho / Cork



Colores textiles / Textiles colours



Zenit Pinboard

Marcos de aluminio / Aluminium frames

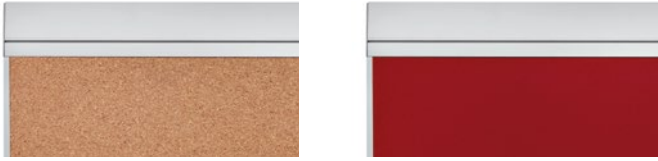

PARED / WALL



CORCHO / CORK

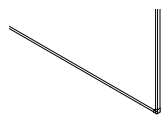

REF	TEXTIL COLOUR	↕ ↔	📏	RAIL	Y2	2,3 cm 0.9 in
Z/765/10		40x60 cm 15.7x23.6 in	2.50 Kg 5.51 Lb			
Z/765/1		60x80 cm 23.6x31.5 in	5 Kg 11.02 Lb			
Z/765/2		80x100 cm 31.5x39.3 in	8 Kg 17.63 Lb	•	•	
Z/765/3		100x120 cm 39.3x47.2 in	12 Kg 26.45 Lb	•	•	
Z/765/4		100x150 cm 39.3x60 in	15 Kg 33.06 Lb	•	•	
Z/765/5		100x175 cm 39.3x70 in	17.5 Kg 38.58 Lb	•		
Z/765/6		100x200 cm 39.3x78.7 in	20 Kg 44.09 Lb		•	
Z/765/7		100x250 cm 39.3x98.4 in	25 Kg 55.11 Lb		•	

PARED / WALL



TEXTILES / TEXTILES

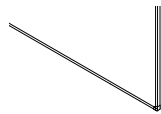

REF	TEXTIL COLOUR	↕ ↔	📏	RAIL	Y2	2,3 cm 0.9 in
Z/760/10	● /NG ● /BD	40x60 cm 15.7x23.6 in	2.50 Kg 5.51 Lb			
Z/760/1	● /GR ● /AC	60x80 cm 23.6x31.5 in	5 Kg 11.02 Lb			
Z/760/2	● /CR ● /AZ	80x100 cm 31.5x39.3 in	8 Kg 17.63 Lb	•	•	
Z/760/3	● /OC ● /VM	100x120 cm 39.3x47.2 in	12 Kg 26.45 Lb	•	•	
Z/760/4	● /NJ ● /VC	100x150 cm 39.3x60 in	15 Kg 33.06 Lb	•	•	
Z/760/5	● /RJ ● /VD	100x175 cm 39.3x70 in	17.5 Kg 38.58 Lb	•		
Z/760/6		100x200 cm 39.3x78.7 in	20 Kg 44.09 Lb		•	
Z/760/7		100x250 cm 39.3x98.4 in	25 Kg 55.11 Lb		•	

Soportes / Supports



COLORES DISPONIBLES / AVAILABLE COLOURS

- /GR
- /AN
- /BL



SOPORTE / SUPPORT

MEDIDAS / SIZES



SOPORTE / SUPPORT			MEDIDAS / SIZES		
			↕ ↔	↕	53 cm
Y2/80/R	Y2/80/R/AN	Y2/80/R/BL	80x100 cm 31.5x39.3 in	173 cm 68.1 in	20.9 in
Y2/120/R	Y2/120/R/AN	Y2/120/R/BL	100x120 cm 39.3x47.2 in		
Y2/150/R	Y2/150/R/AN	Y2/150/R/BL	100x150 cm 39.3x60 in		
Y2/200/R	Y2/200/R/AN	Y2/200/R/BL	120x200 cm 47.2x78.7 in		
Y2/250/R	Y2/250/R/AN	Y2/250/R/BL	120x250 cm 47.2x96.7 in		



MÁS DETALLES SOBRE EL SOPORTE / MORE DETAILS ABOUT THE SUPPORT



Basic Pinboard

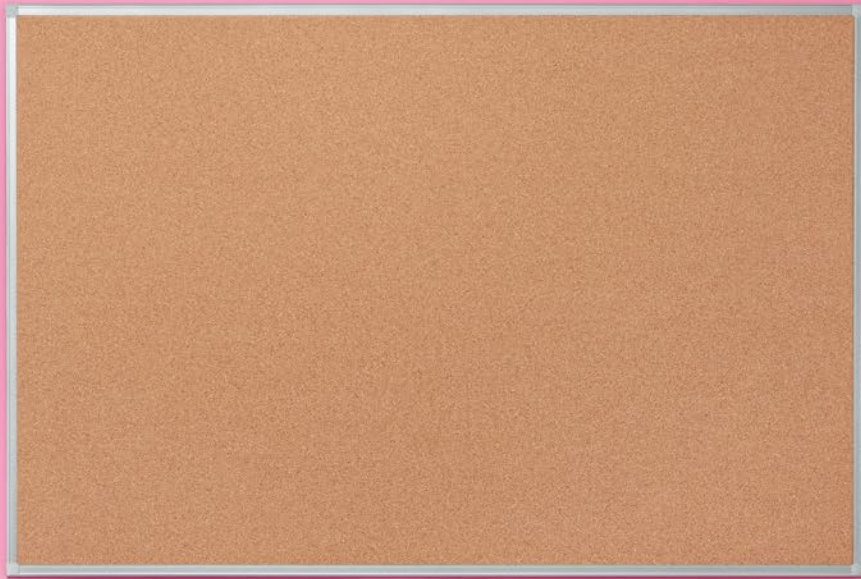

Tablero de anuncios de corcho natural enmarcado con perfil de aluminio extrusionado Basic anodizado en plata mate y dotado de cantoneras redondeadas de plástico gris. Sobre su superficie se pueden fijar notas, avisos, comunicados, mediante agujas o chinchetas.

Notice board in natural cork framed with a basic extruded aluminium profile anodized in matt silver and equipped with rounded grey plastic corner pieces. Notes, notices can be attached to its surface using pins or thumbtacks.

Tableau d'affichage en liège naturel encadré d'un profilé en aluminium extrudé Basic anodisé en argent mat et équipé de coins arrondis en plastique gris. Les notes, avis, communiqués etc. Peuvent être fixés sur la surface à l'aide d'aiguilles ou de punaises.

Bacheca in sughero naturale incorniciata da un profilo di base in alluminio estruso anodizzato in argento opaco e dotata di angoli arrotondati in plastica grigia. Note e avvisi possono essere attaccati alla sua superficie con spilli o puntine. Spessore del sughero 5 mm.

Medidas / Sizes

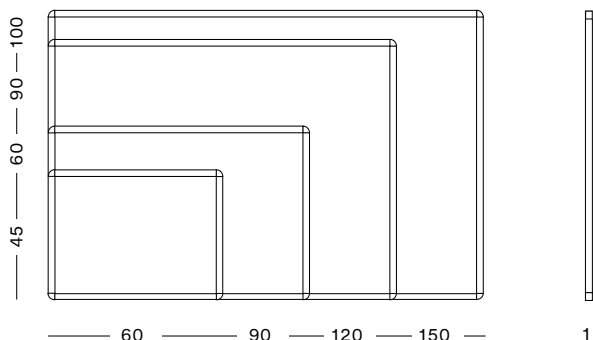

Especificaciones / Specifications



Corcho / Cork



Marco de aluminio / Aluminium frame

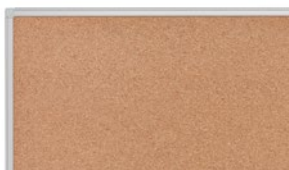

PARED / WALL

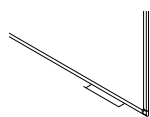

REF	↕ ↔	📏	1 cm
BL/IN/0101	45x60 cm 17.7x23.6 in	0.7 Kg 1.54 Lb	0.4 in
BL/IN/0102	60x90 cm 23.6x35.4 in	1.25 Kg 2.75 Lb	
BL/IN/0103	90x120 cm 35.4x47.2 in	2.5 Kg 5.51 Lb	
BL/IN/0114	100x150 cm 39.3x59 in	4.2 Kg 9.25 Lb	

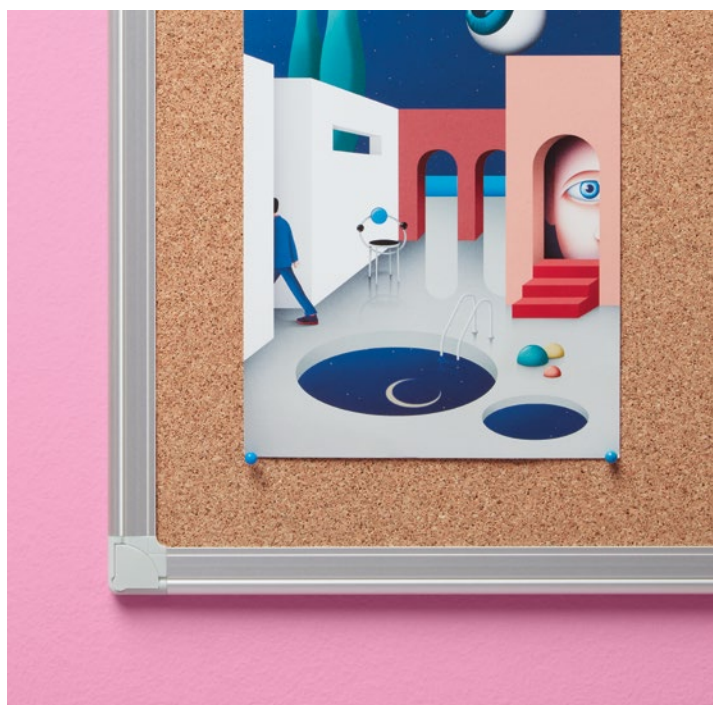

Pinboards Showcase



Vitrina de anuncios mural fabricada con perfil de aluminio anodizado plata mate y dotada de cantoneras de zamak color gris. Fondo de corcho natural, corcho tapizado disponible en textil de 12 colores o fondo blanco magnético. Puertas correderas deslizantes de metacrilato transparente y cerradura de seguridad con juego de llaves. Grosor del corcho 5 mm. Vitrinas para uso interior.

Wall display cabinet made of matt silver anodized aluminium profile and equipped with grey zamak corner pieces. Natural cork background, upholstered cork available in 12 textile colors or magnetic white background. Transparent methacrylate sliding doors and security lock with a set of keys. Cork thickness 5 mm. Showcases for indoor use.

Vitrine murale fabriquée en profilé d'aluminium anodisé argent mat et équipée d'angles en zamak gris. Fond en liège naturel, liège rembourré disponible en textile dans 12 couleurs ou fond magnétique blanc. Portes coulissantes transparentes en méthacrylate et serrure de sécurité avec jeu de clés. Epaisseur du liège 5 mm. Vitrine pour un usage intérieur.

Vetrina a parete realizzata con profilo in alluminio anodizzato argento opaco e dotata di angolari in zama grigia. Fondo in sughero naturale, sughero imbottito disponibile in tessuto in 12 colori o fondo bianco magnetico. Porte scorrevoli in metacrilato trasparente e serratura di sicurezza con set di chiavi. Spessore del sughero 5 mm. Vetrine per uso interno.

Medidas / Sizes

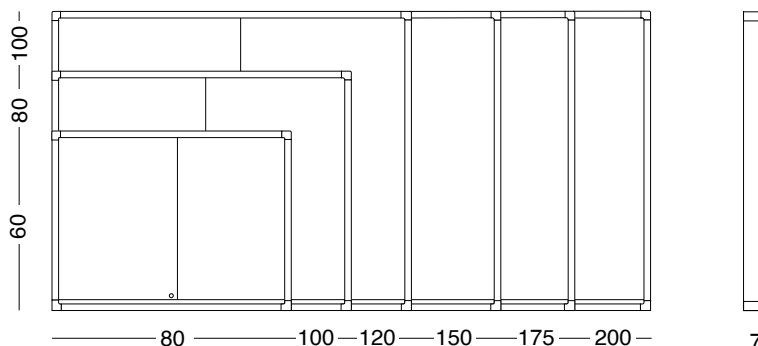

Especificaciones / Specifications



Corcho / Cork



Magnético / Magnetic



Colores textiles / Textiles colours

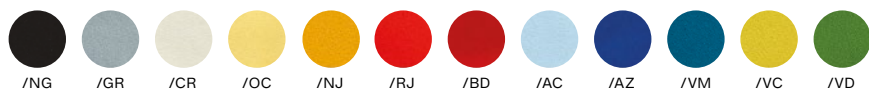

/NG /GR /CR /OC /NJ /RJ /BD /AC /AZ /VM /VC /VD



Pinboards Showcase

Marcos de aluminio / Aluminium frames

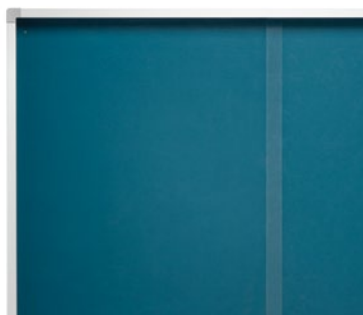
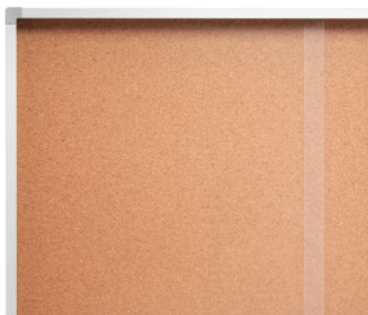

PARED / WALL



CORCHO / CORK

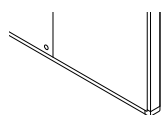

REF	↕ ↔	⚖
765/V1	60x80 cm 23.6x31.5 in	10 Kg 22 Lb
765/V2	80x100 cm 31.5x39.3 in	17 Kg 37.4 Lb
765/V3	100x120 cm 39.3x47.2 in	23 Kg 50.7 Lb
765/V4	100x150 cm 39.3x60 in	30 Kg 66.1 Lb
765/V5	100x175 cm 39.3x70 in	32 Kg 70.5 Lb
765/V6	100x200 cm 39.3x78.7 in	35 Kg 77.1 Lb

7 cm
2.7 in

PARED / WALL



TEXTILES / TEXTILES

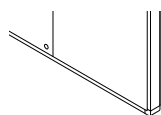

REF	↕ ↔	⚖	COLORES / COLOURS
760/V1	60x80 cm 23.6x31.5 in	10 Kg 22 Lb	● /NG ● /BD
760/V2	80x100 cm 31.5x39.3 in	17 Kg 37.4 Lb	● /GR ● /AC
760/V3	100x120 cm 39.3x47.2 in	23 Kg 50.7 Lb	● /CR ● /AZ
760/V4	100x150 cm 39.3x60 in	30 Kg 66.1 Lb	● /OC ● /VM
760/V5	100x175 cm 39.3x70 in	32 Kg 70.5 Lb	● /NJ ● /VC
760/V6	100x200 cm 39.3x78.7 in	35 Kg 77.1 Lb	● /RJ ● /VD

7 cm
2.7 in

PARED / WALL

PIZARRA BLANCA MAGNÉTICA / MAGNETIC WHITEBOARD

→ ←

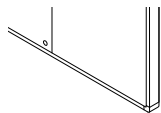

REF	↕ ↔	📏	
720/V1	60x80 cm 23.6x31.5 in	17,0 Kg 37,0 Lb	
720/V2	80x100 cm 31.5x39.3 in	22,0 Kg 48,5 Lb	
720/V3	100x120 cm 39.3x47.2 in	29,0 Kg 63,9 Lb	
720/V4	100x150 cm 39.3x60 in	34,0 Kg 74,9 Lb	
720/V5	100x175 cm 39.3x70 in	38,0 Kg 83,7 Lb	
720/V6	100x200 cm 39.3x78.7 in	42,0 Kg 92,5 Lb	

7 cm
2.7 in

Basic Showcase



Colección de vitrinas Basic fabricadas con perfil de aluminio anodizado plata mate y dotadas de cantoneras redondeadas grises en las esquinas. Puerta de apertura batiente de metacrilato transparente con cerradura y llave. Disponibles en acabado blanco rotulable magnético y en corcho natural para sujetar avisos y notas mediante agujas o chinchetas. Vitrinas para uso interior.

Collection of Basic showcases made with a matt silver anodized aluminium profile and equipped with grey rounded corner pieces. Transparent methacrylate hinged opening door with lock and key. Available in white magnetic labeling finish and in natural cork to hold notices and notes using thumbtacks or pushpins. Showcases for indoor use.

Collection de vitrines Basic réalisées avec un profil en aluminium anodisé argent mat et équipées de coins arrondis gris. Porte battante à charnière en méthacrylate transparent avec serrure et clé. Fond disponible dans une finition magnétique blanche effaçable à sec ou en liège naturel pour fixer vos informations à l'aide d'aiguilles ou de punaises. Vitrine pour un usage intérieur.

Collezione di vetrine Basic realizzate con profilo in alluminio anodizzato argento opaco e dotate di angoli arrotondati grigi. Anta a battente in metacrilato trasparente con serratura e chiave. Disponibili in finitura bianca per etichette magnetiche e in sughero naturale per contenere avvisi e appunti con puntine da disegno o spille. Vitrini per uso interno.

Medidas / Sizes

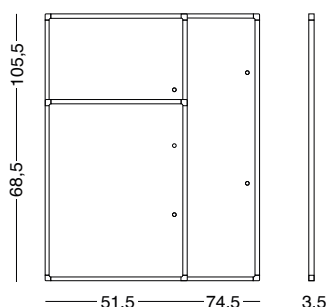

Especificaciones + opciones / Specifications + options



Marcos de aluminio / Aluminium frames

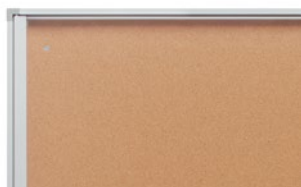

PARED / WALL

 TABLERO DE ANUNCIOS / PINBOARD

 PIZARRA BLANCA / WHITEBOARD

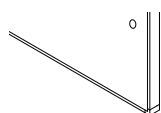

REF	↕ ↔	🏷️	📄
BL/IN/0150	68,5x51,5 cm 26.9x20.2 in	4,5 Kg 9.9 Lb	4
BL/IN/0151	100,5x51,5 cm 39.5x20.2 in	6,5 Kg 14.3 Lb	6
BL/IN/0152	100,5x74,5 cm 39.5x29.3 in	8,7 Kg 19.1 Lb	9

REF	↕ ↔	🏷️	📄	3,5 cm 1.3 in
BL/IN/0110	68,5x51,5 cm 26.9x20.2 in	4,5 Kg 9.9 Lb	4	
BL/IN/0111	100,5x51,5 cm 39.5x20.2 in	6,5 Kg 14.3 Lb	6	
BL/IN/0112	100,5x74,5 cm 39.5x29.3 in	8,7 Kg 19.1 Lb	9	

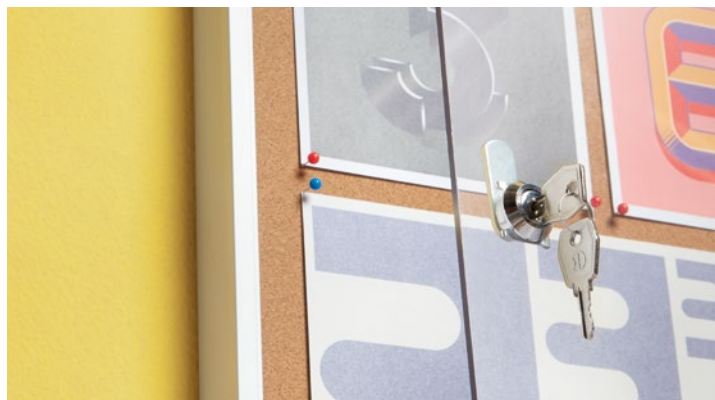

Outdoor Showcase



Vitrinas para exterior fabricadas con perfiles de aluminio anodizados plata mate y cantoneras redondeadas de plástico gris con detalle opcional de color (kit de 5 colores incluido). Puerta batiente de cristal templado dotada de cerradura con llave. Superficie rotulable magnética para uso con imanes. Estancas a la lluvia por lo que permiten su ubicación a la intemperie.

Outdoor display cabinets made of matt silver anodized aluminium profiles and rounded grey plastic corner pieces with optional colour detail. (5 colour kit included). Hinged tempered glass door with key lock. Magnetic labeling surface for use with magnets. Waterproof allowing outdoor use.

Vitrines extérieures en profilés d'aluminium anodisé argent mat et coins arrondis en plastique gris avec détail de couleur en option. (Kit 5 couleurs inclus). Porte en verre trempé à ouverture télescopique équipée d'une double serrure à clé. Surface magnétique à utiliser avec des aimants. Imperméable et résistante à la pluie ce qui vous permet l'installer à l'extérieur.

Vitrines extérieures en profilés d'aluminium anodisé argent mat et coins arrondis en plastique gris avec détail de couleur en option. (Kit 5 couleurs inclus). Porte en verre trempé à ouverture télescopique équipée d'une double serrure à clé. Surface magnétique à utiliser avec des aimants. Imperméable et résistante à la pluie ce qui vous permet l'installer à l'extérieur.

Medidas / Sizes

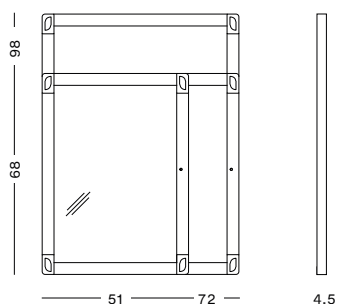

Especificaciones / Specifications



Marco de aluminio / Aluminium frame

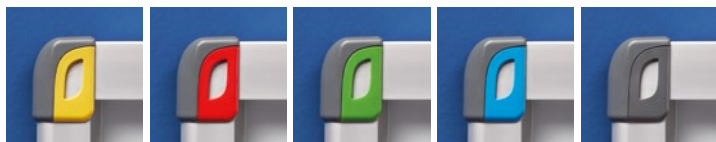
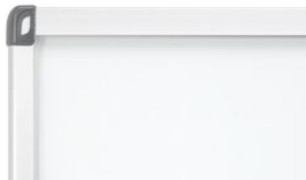

PARED / WALL	PIZARRA BLANCA / WHITEBOARD		→ ←		
REF	↕ ↔	⊠ ⊠	⚖	A4	4,5 cm
767/VE/12	68x51 cm 26.5x20 in	59,4x41,8 cm 23.3x16.4 in	4,5 Kg 9.9 Lb	4	1.8 in
767/VE/13	68x72 cm 26.5x28.3 in	59,4x62,8cm 23.3x24.7 in	6,5 Kg 14.3 Lb	6	
767/VE/14	98x72 cm 38.6x28.3 in	89,1x62,8 cm 35x24.7 in	8,7 Kg 19.1 Lb	9	

* Piezas de colores incluidas
Included color pieces
Pièces de couleur incluses
Pezzi colorati inclusi



Outdoor Telescopic Showcase

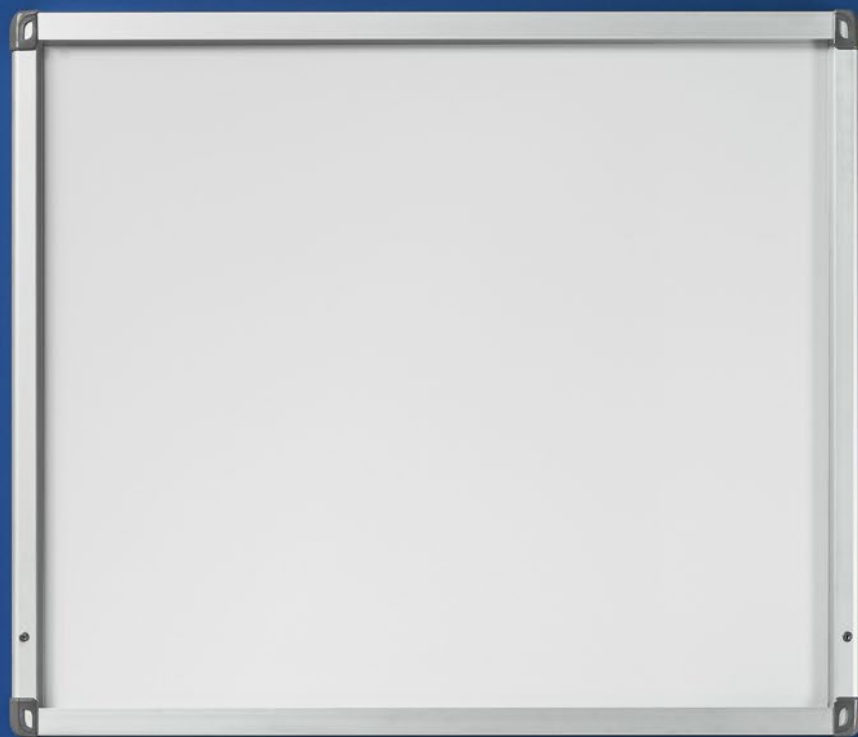

Vitrinas para exterior fabricadas con perfiles de aluminio anodizados plata mate y cantoneras redondeadas de plástico gris con detalle opcional de color (kit de 5 colores incluido). Puerta con apertura telescópica de cristal templado dotada de doble cerradura con llave. Superficie rotulable magnética para uso con imanes. Estancas a la lluvia por lo que permiten su ubicación a la intemperie.

Outdoor display cabinets made of matt silver anodized aluminium profiles and rounded grey plastic corner pieces with optional color detail. (5 colour kit included). Tempered glass door with telescopic opening equipped with a double key lock. Magnetic labeling surface for use with magnets. Waterproof allowing outdoor use.

Vitrines extérieures en profilés d'aluminium anodisé argent mat et coins arrondis en plastique gris avec détail de couleur en option. (Kit 5 couleurs inclus). Porte en verre trempé à ouverture télescopique équipée d'une double serrure à clé. Surface magnétique à utiliser avec des aimants. Imperméable et résistante à la pluie ce qui vous permet l'installer à l'extérieur.

Vitrines extérieures en profilés d'aluminium anodisé argent mat et coins arrondis en plastique gris avec détail de couleur en option. (Kit 5 couleurs inclus). Porte en verre trempé à ouverture télescopique équipée d'une double serrure à clé. Surface magnétique à utiliser avec des aimants. Imperméable et résistante à la pluie ce qui vous permet l'installer à l'extérieur.

Medidas / Sizes

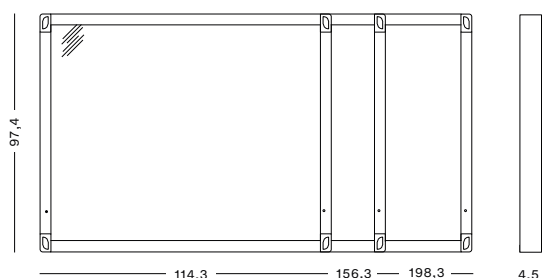

Especificaciones / Specifications



Marco de aluminio / Aluminium frame

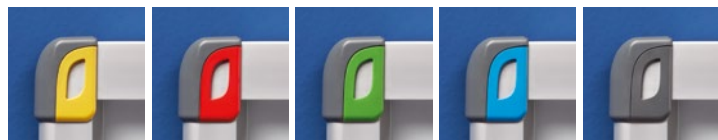

PARED / WALL	PIZARRA BLANCA / WHITEBOARD				↔ ←
REF	↕ ↔	⊠ ⊠	⚖	📄	4,5 cm
768/VE/11	97,4x114,3 cm 39x47.6 in	89,2x105 cm 35.1x41.3 in	18,5 Kg 40.78 Lb	15	1.7 in
768/VE/12	97,4x156,3 cm 39x64.2 in	89,2x147cm 35.1x57.8 in	25,5 Kg 56.21 Lb	21	
768/VE/13	97,4x198,3 cm 39.7x80.3 in	89,2x189 cm 35.1x74.4 in	31 Kg 68.38 Lb	27	

* Piezas de colores incluidas
Included color pieces
Pièces de couleur incluses
Pezzi colorati inclusi



Partitions

Ten Limit General - Ten Limit General	120
Ten Limit Acoustic Screen - Ten Limit Pantalla Acústica	122
Ten Limit Board - Ten Limit Pizarra	124
Ten Limit Acrylic Screen - Ten Limit Pantalla Acrílica	126
Antibacterial Ten Limit Screen - Ten Limit Pantalla Antibacteriana	128
Limit General - Limit General	130
Limit Acoustic Screen - Limit Pantalla Acústica	132
Limit Board - Limit Pizarra	134
Limit Acrylic Screen - Limit Pantalla Acrílica	136
Antibacterial Limit Screen - Limit Pantalla Antibacteriana	138
Ribbed Acrylic Screen - Separador de mesa Acanalado	140



Comunicar, exhibir, mostrar... debe hacerse de manera ordenada. En Planning Sisplamo queremos colaborar ofreciendo una gama de productos que no solo comuniquen o exhiban con claridad, nos hemos esforzado en lograr un producto que genere un espacio acorde a cada necesidad, un póster o anuncio, un menú en una cafetería, la delimitación de un espacio en un museo, o un portafolletos en una feria, son algunos de los complementos que ofrecemos en esta familia de productos. Pretendemos ofrecer una gama eficaz.

Communiquer, exposer, montrer ... doit se faire de manière ordonnée. Chez Planning Sisplamo nous voulons collaborer en offrant une gamme de produits qui communiquent ou affichent clairement. Nous nous sommes efforcés à réaliser un produit qui génère un espace en fonction de chaque besoin, une affiche ou une publicité, un menu dans une cafétéria, la délimitation d'un espace dans un musée, ou d'un porte-brochures lors d'une foire, sont quelques-uns des accessoires que nous proposons dans cette famille de produits. Il s'agit d'une gamme performante et efficace.

Communicate, exhibit, show ... should be done in an orderly manner. At Planning Sisplamo we want to collaborate by offering a range of products that not only communicate or display clearly, we have strived to achieve a product that generates an environment according to each necessity, a poster or advertisement, a menu in a restaurant, the cordoning off of an area in a museum, or a brochure holder at a fair, are some of the accessories we offer in this product family. We intend to offer an efficient range.

Comunicare, esporre, mostrare... deve essere fatto in modo ordinato. Noi di Planning Sisplamo vogliamo collaborare offrendo una gamma di prodotti che non solo comunichino o esponano in modo chiaro, ma ci siamo sforzati di realizzare un prodotto che generi uno spazio in base a ogni esigenza, un poster o una pubblicità, un menu in una caffetteria, la delimitazione di uno spazio in un museo o un portadepliant in una fiera, sono alcuni dei complementi che offriamo in questa famiglia di prodotti. Il nostro obiettivo è offrire una gamma efficace.

Ten Limit General

Ten Limit Screens, su estructura consta de un perfil de aluminio anodizado disponible en plata mate, acado en antracita y blanco, con pies Y2 de fundición de aluminio con ruedas. Cuenta con cuatro diferentes tipos de superficies para el interior del marco. PET reciclado con propiedades acusticas disponible en 18 colores, Superficie de pizarra blanca rotulable y magnética apta para uso de imanes en las dos caras, policarbonato de diversos acabados y transparencia, y por último tres 3 colores de melamina antibacteriana fácil de limpiar.

Ten Limit Screens, its structure consists of an anodized aluminum profile available in matt silver, anthracite and white, with cast aluminum Y2 feet with wheels. It has four different types of surfaces for the inside of the frame. Recycled PET with acoustic properties available in 18 colours, a signable and magnetic whiteboard surface suitable for the use of magnets on both sides, polycarbonate with various finishes and transparency, and finally three 3 colors of easy-to-clean antibacterial melamine.

Ten Limit Screens, sa structure est constituée d'un profil en aluminium anodisé disponible en argent mat, anthracite et blanc, avec pieds Y2 en fonte d'aluminium avec roulettes. Il a quatre types de surfaces différentes pour l'intérieur du cadre. PET recyclé aux propriétés acoustiques disponible en 18 couleurs, une surface de tableau blanc signable et magnétique adaptée à l'utilisation d'aimants des deux côtés, du polycarbonate avec différentes finitions et transparences, et enfin trois 3 couleurs de mélamine antibactérienne facile à nettoyer.

Ten Limit Screen, la sua struttura è costituita da un profilo in alluminio anodizzato disponibile in argento opaco, antracite e bianco, con piedi Y2 in fusione di alluminio con ruote. Ha quattro diversi tipi di superfici per l'interno del telaio. PET riciclato con proprietà acustiche disponibile in 18 colori, una superficie lavagna segnabile e magnetica adatta all'uso di magneti su entrambi i lati, policarbonato con varie finiture e trasparenze, e infine tre 3 colori di melamina antibatterica facile da pulire.



Ten Limit Screen General

Ten Limit Acoustic Screen [VIEW ON PAGE: 122](#)



Ten Limit Acrylic Screen [VIEW ON PAGE: 126](#)



Ten Limit Board [VIEW ON PAGE: 124](#)



Antibacterial Ten Limit Screen [VIEW ON PAGE: 128](#)



Ten Limit Acoustic Screen

Marco de aluminio / Aluminium frame Medidas / Sizes

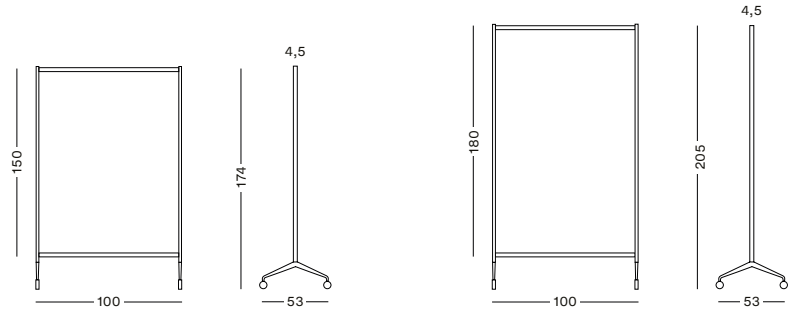

Especificaciones / Specifications

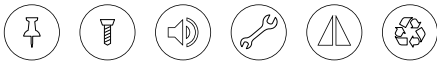

Colores / Colours

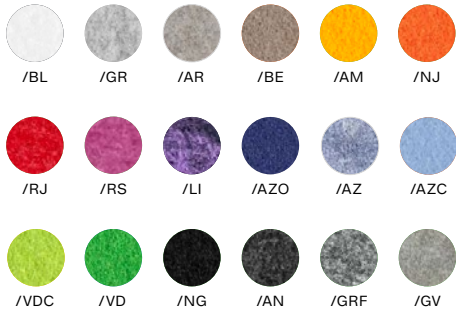

Marcos de color / Coloured frames



↗ ↖ ↗ ↖



- TL/150/FA ● TL/150/FA/AN ○ TL/150/FA/BL
- TL/180/FA ● TL/180/FA/AN ○ TL/180/FA/BL

- COLORES / COLOURS**
- /BL ● /AZO
 - /GR ● /AZ
 - /AR ● /AZC
 - /BE ● /VDC
 - /AM ● /VD
 - /NJ ● /NG
 - /RJ ● /AN
 - /RS ● /GRF
 - /LI ● /GV

↕ ↔ SCREEN
 150x100 cm
 59,05x39,3 in
 180x100 cm
 70,8x39,3 in

↕
 175 cm
 68.8 in
 205 cm
 80.7 in

⚖
 8 Kg
 17.6 Lb
 9 Kg
 19.8 Lb

4,5 cm 53 cm
 1.7 in 20.8 in



Ten Limit Board

Marco de aluminio / Aluminium frame

Medidas / Sizes

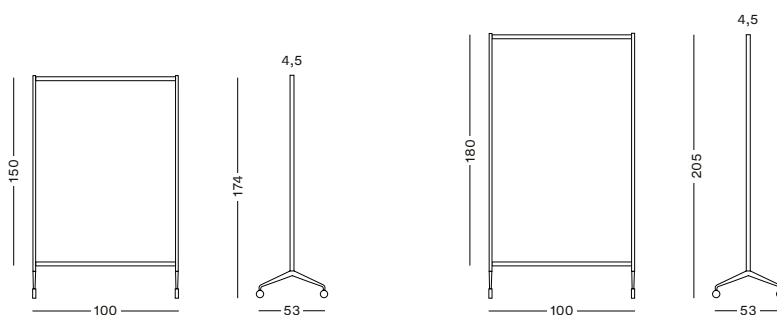

Especificaciones / Specifications



Marcos de color / Coloured frames



PIZARRA BLANCA / WHITEBOARD



- TL/150/PI ● TL/150/PI/AN ○ TL/150/PI/BL
- TL/180/PI ● TL/180/PI/AN ○ TL/180/PI/BL

↕ ↔ BOARD
 150x100 cm
 59,05x39,3 in

↕
 174 cm
 68.5 in

⚖️
 19 Kg
 41.9 Lb

4,5 cm
 1.7 in

53 cm
 20.8 in



Ten Limit Acrylic Screen

Medidas / Sizes

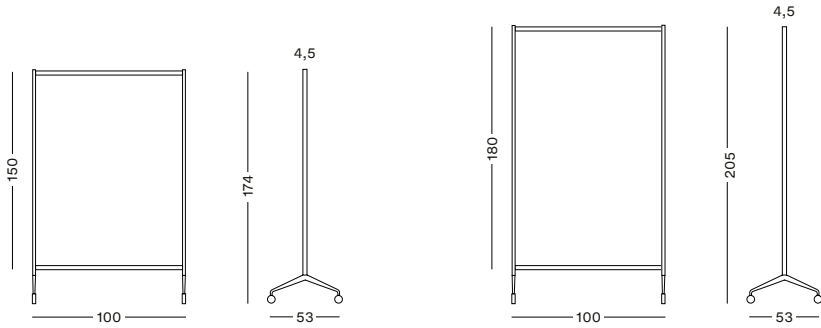

Especificaciones / Specifications



Marco de aluminio / Aluminium frame



Opciones / Options

RIBBED TRANSLUCENT

RIBBED SEMI TRANSPARENT

TRANSPARENT 100%



1

2

3

 MARCO PLATA / SILVER FRAME

→ ←

→ ←



1

TL/150/PX

2

TL/150/TR

3

TL/150/SAN

↕ ↔

150x100 cm
59,05x39,3 in

↕

174 cm
68.5 in

⚖

8 Kg
17.6 Lb

4,5 cm
1.7 in

53 cm
20.8 in

TL/180/PX

TL/180/TR

TL/180/SAN

180x100 cm
70,8x39,3 in

205 cm
80.7 in

9 Kg
19.8 Lb

 MARCO ANTRACITA / ANTHRACITE FRAME

→ ←

→ ←



1

TL/150/PX/AN

2

TL/150/TR/AN

3

TL/150/SAN/AN

↕ ↔

150x100 cm
59,05x39,3 in

↕

174 cm
68.5 in

⚖

8 Kg
17.6 Lb

4,5 cm
1.7 in

53 cm
20.8 in

TL/180/PX/AN

TL/180/TR/AN

TL/180/SAN/AN

180x100 cm
70,8x39,3 in

205 cm
80.7 in

9 Kg
19.8 Lb

 MARCO BLANCO / WHITE FRAME

→ ←

→ ←



1

TL/150/PX/BL

2

TL/150/TR/BL

3

TL/150/SAN/BL

↕ ↔

150x100 cm
59,05x39,3 in

↕

174 cm
68.5 in

⚖

8 Kg
17.6 Lb

4,5 cm
1.7 in

53 cm
20.8 in

TL/180/PX/BL

TL/180/TR/BL

TL/180/SAN/BL

180x100 cm
70,8x39,3 in

205 cm
80.7 in

9 Kg
19.8 Lb

Antibacterial Ten Limit Screen

Marco de aluminio / Aluminium frame

Medidas / Sizes

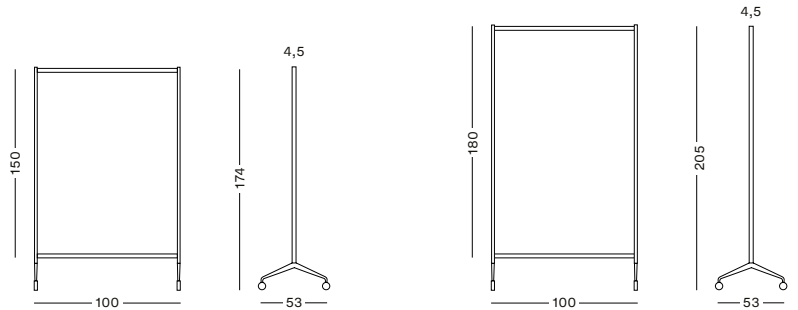

Especificaciones / Specifications



Opciones / Options

ANTIBACTERIAL GREY

ANTIBACTERIAL GRAPHITE

ANTIBACTERIAL WHITE

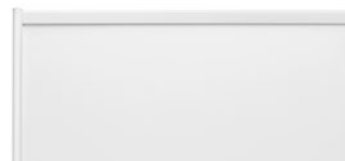
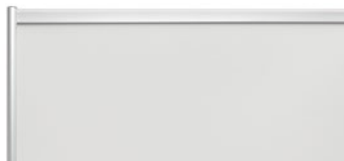

MARCO PLATA / SILVER FRAME

↔ ↔



TL/150/AB/GR

TL/180/AB/GR



TL/150/AB/GG

TL/180/AB/GG



TL/150/AB/BL

TL/180/AB/BL



150x100 cm
59,05x39,3 in

180x100 cm
70,8x39,3 in



174 cm
68.5 in

205 cm
80.7 in



10 Kg
22 Lb

12 Kg
26.4 Lb

4,5 cm
1.7 in

53 cm
20.8 in

MARCO ANTRACITA / ANTHRACITE FRAME

↔ ↔



TL/150/AB/AN/GR

TL/180/AB/AN/GR



TL/150/AB/AN/GG

TL/180/AB/AN/GG



TL/150/AB/AN/BL

TL/180/AB/AN/BL



150x100 cm
59,05x39,3 in

180x100 cm
70,8x39,3 in



174 cm
68.5 in

205 cm
80.7 in



10 Kg
22 Lb

12 Kg
26.4 Lb

4,5 cm
1.7 in

53 cm
20.8 in

MARCO BLANCO / WHITE FRAME

↔ ↔

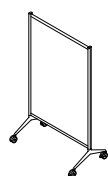

TL/150/AB/BL/GR

TL/180/AB/BL/GR



TL/150/AB/BL/GG

TL/180/AB/BL/GG



TL/150/AB/BL/BL

TL/180/AB/BL/BL



150x100 cm
59,05x39,3 in

180x100 cm
70,8x39,3 in



174 cm
68.5 in

205 cm
80.7 in



10 Kg
22 Lb

12 Kg
26.4 Lb

4,5 cm
1.7 in

53 cm
20.8 in



Limit General

Limit Screens, su struttura consta de un perfil de aluminio anodizado disponible en plata mate, lacado en gris antracita y blanco, con pies trapezoidales metálicos a juego. Cuenta con cuatro diferentes tipos de superficies para el interior del marco. PET reciclado con propiedades acusticas disponible en 18 colores, Superficie de pizarra blanca rotulable y magnética apta para uso de imanes en las dos caras, policarbonato de diversos acabados y transparencia, y por último tres 3 colores de melamina antibacteriana fácil de limpiar.

Limit Screens, its structure consists of an anodized aluminum profile available in matt silver, lacquered in anthracite gray and white, with matching metal trapezoidal feet. It has four different types of surfaces for the inside of the frame. Recycled PET with acoustic properties available in 18 colours, a magnetic and labelable whiteboard surface suitable for the use of magnets on both sides, polycarbonate with various finishes and transparency, and finally three 3 colors of easy-to-clean antibacterial melamine.

Limit Screens, sa structure est constituée d'un profilé en aluminium anodisé disponible en argent mat, laqué en gris anthracite et blanc, avec des pieds trapézoïdaux en métal assortis. Il a quatre types de surfaces différentes pour l'intérieur du cadre. PET recyclé aux propriétés acoustiques disponible en 18 couleurs, une surface de tableau blanc signable et magnétique adaptée à l'utilisation d'aimants des deux côtés, du polycarbonate avec différentes finitions et transparences, et enfin trois 3 couleurs de mélamine antibactérienne facile à nettoyer.

Limit Screens, la sua struttura è costituita da un profilo in alluminio anodizzato disponibile in argento opaco, laccato grigio antracite e bianco, con piedini trapezoidali in metallo in tinta. Ha quattro diversi tipi di superfici per l'interno del telaio. PET riciclato con proprietà acustiche disponibile in 18 colori, una superficie lavagna segnabile e magnetica adatta all'uso di magneti su entrambi i lati, policarbonato con varie finiture e trasparenze, e infine tre 3 colori di melamina antibatterica facile da pulire.



Limit Acoustic Screen [→ VIEW ON PAGE: 132](#)



Limit Acrylic Screen [→ VIEW ON PAGE: 136](#)



Limit Board [→ VIEW ON PAGE: 134](#)



Antibacterial Limit Screen [→ VIEW ON PAGE: 138](#)



Limit Acoustic Screen

Marcos de aluminio / Aluminium frames

Medidas / Sizes

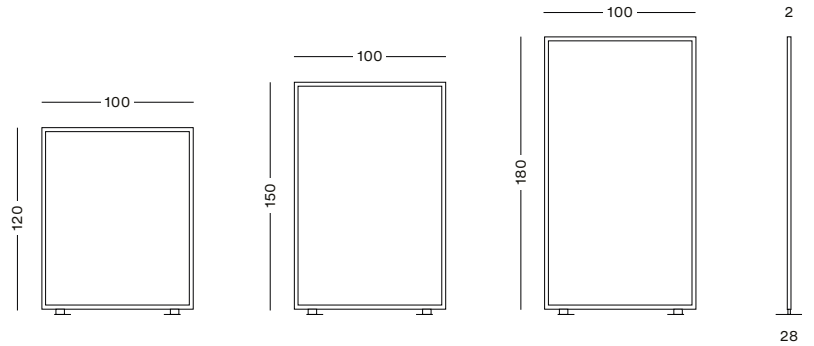

Especificaciones / Specifications



Colores / Colours



Marcos de color / Colored frames

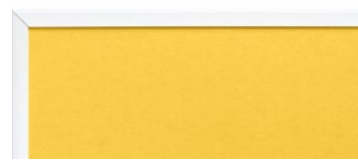
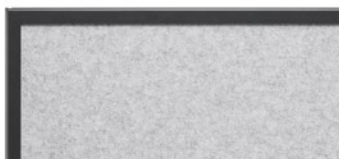
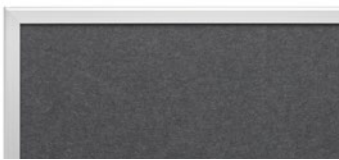

ACCESORIOS/ ACCESORIES

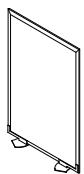

●	●	○	↕↔	👤	2 cm
300/1/FA	300/1/FA/AN	300/1/FA/BL	120x100 cm 47.2x39.3 in	10 Kg 22.04 Lb	0.8 in
300/2/FA	300/2/FA/AN	300/2/FA /BL	150x100 cm 59.05x39.3 in	12,4 Kg 27.33 Lb	
300/3/FA	300/3/FA/AN	300/3/FA /BL	180x100 cm 70.8x39.3 in	14,9 Kg 32.84 Lb	

REF	↕↔	⊙
300/K	2x5 cm 0.78x1.96 in	2
300/K/4	5x5 cm 1.96x1.96 in	4

Otros acabados / *Other finishes*

Acrylic Screen —————> VIEW ON PAGE: 136



Writeboard Screen —————> VIEW ON PAGE: 78

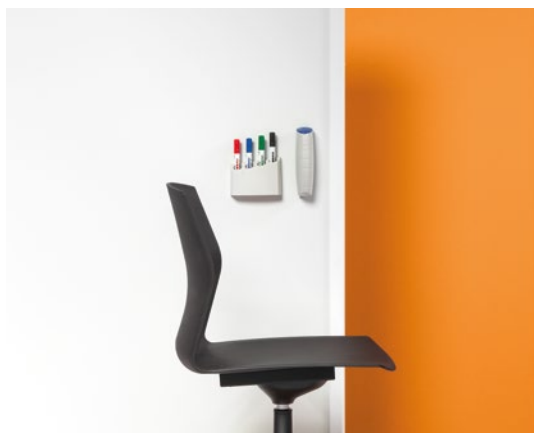

Antibacterial Screen —————> VIEW ON PAGE: 138

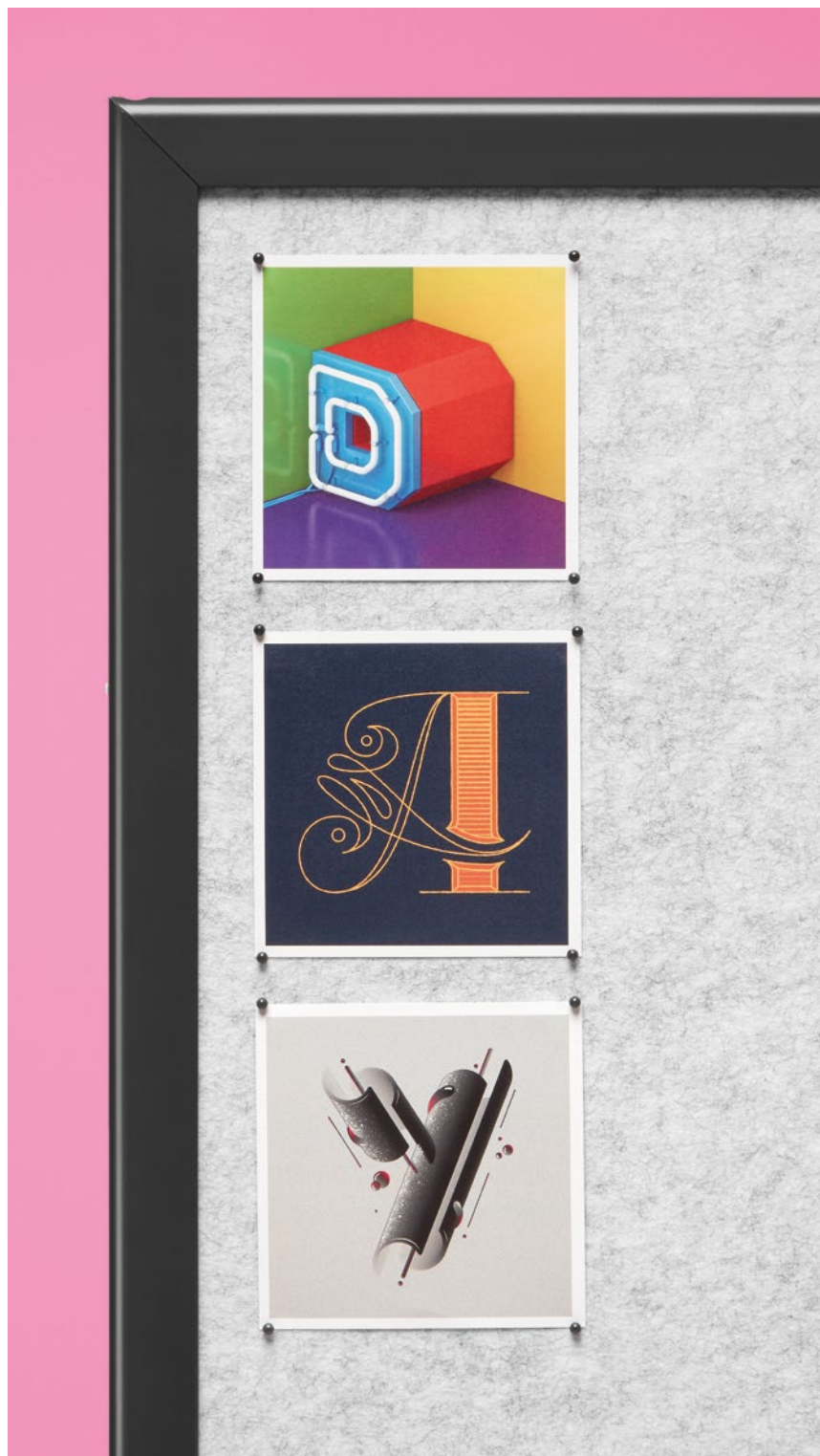

Limit Board

Marcos de aluminio / Aluminium frames

Medidas / Sizes

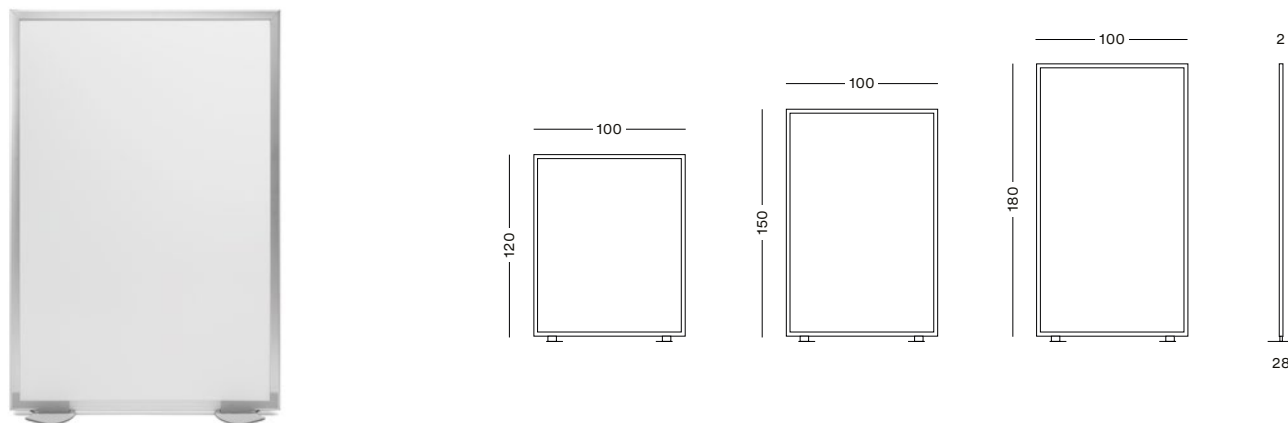

Marcos de aluminio / Aluminium frames



Marcos de color / Colored frames

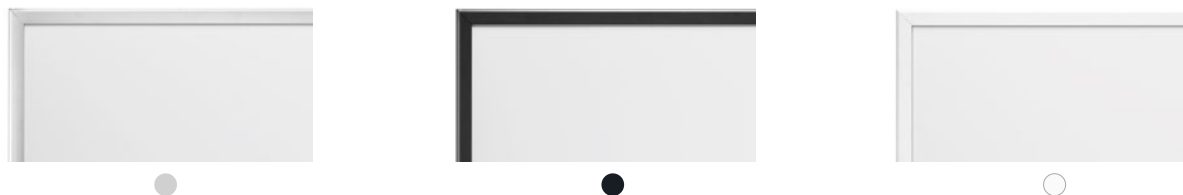

 PIZARRA BLANCA / WHITEBOARD



ACCESORIOS / ACCESSORIES



300/1/PI



300/1/PI/AN



300/1/PI/BL



120x100 cm
47.2x39.3 in



21 Kg
46,29 Lb

2 cm
0.78 in

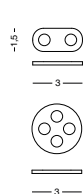

REF

300/K



2x5 cm
0.78x1.96 in



2

300/K/4

5x5 cm
1.96x1.96 in

4

300/2/PI

300/2/PI/AN

300/2/PI/BL

150x100 cm
59.05x39.3 in

26,1 Kg
57,54 Lb

300/3/PI

300/3/PI/AN

300/3/PI/BL

180x100 cm
70.8x39.3 in

31,3 Kg
69 Lb

Otros acabados / *Other finishes*

Acrylic Panel → VIEW ON PAGE: 136



Acoustic Panel → VIEW ON PAGE: 146

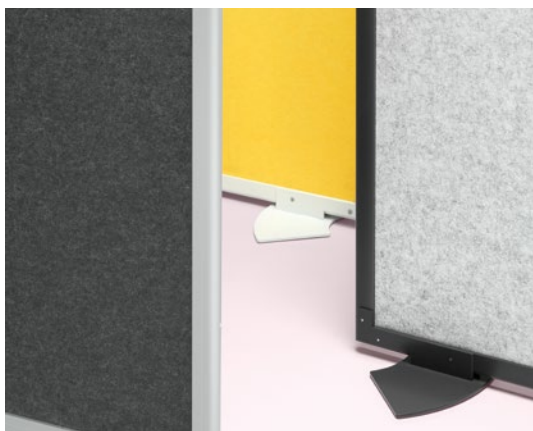

Antibacterial Panel → VIEW ON PAGE: 138

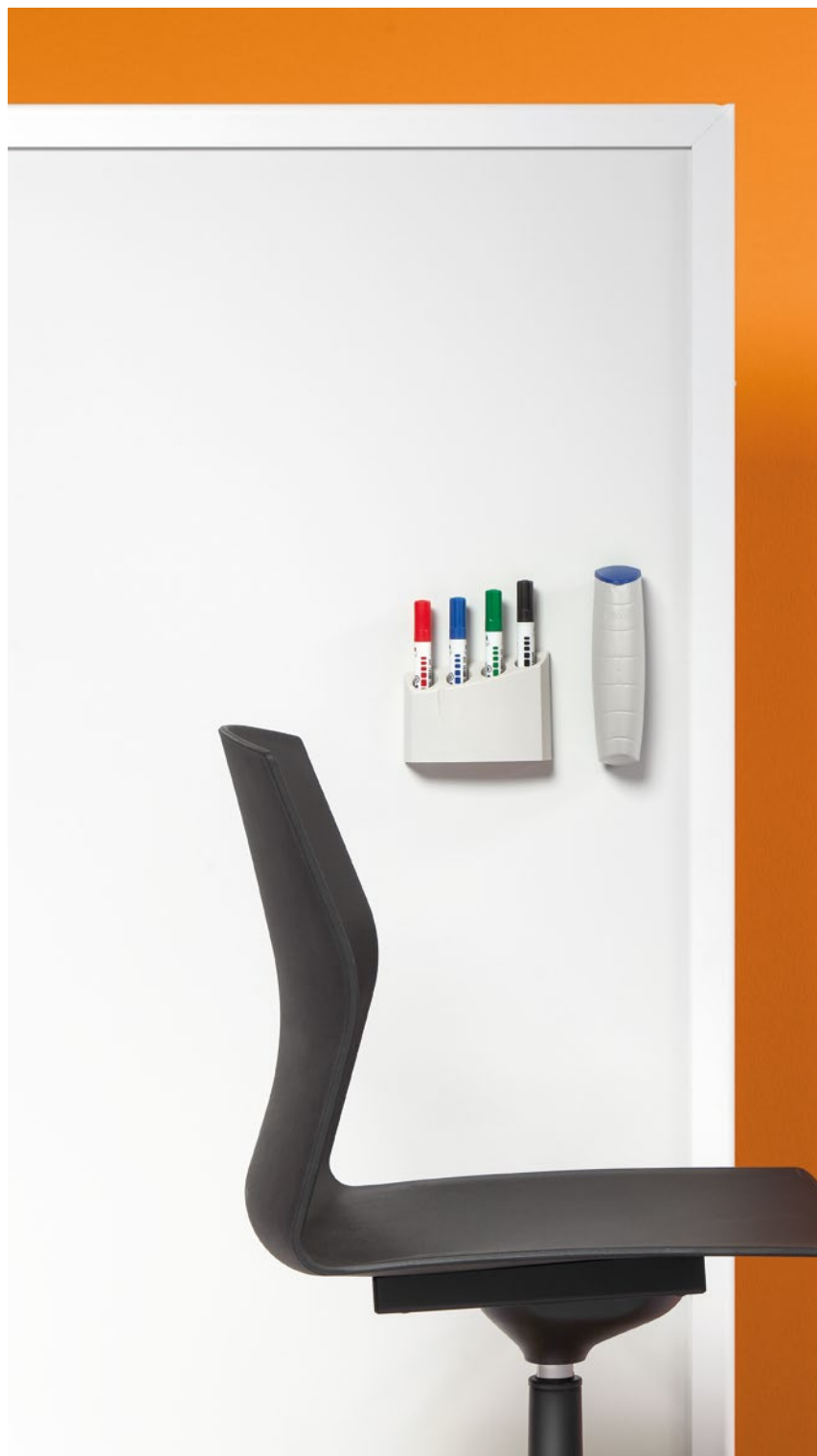

Limit Acrylic Screen

Medidas / Sizes

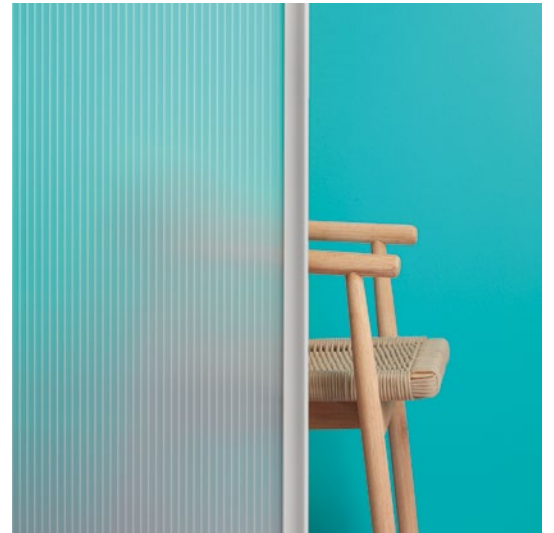
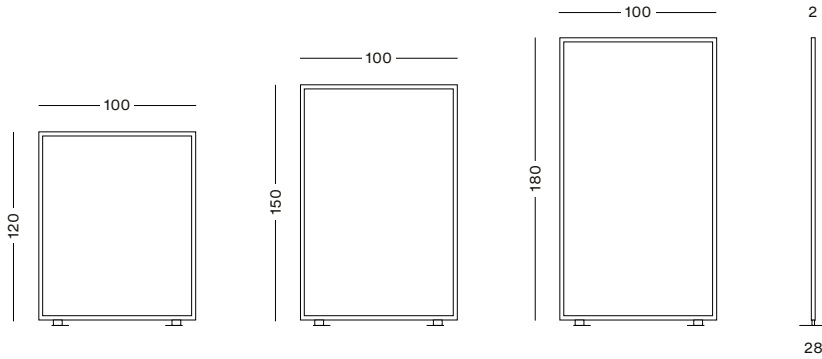

Especificaciones / Specifications



Marcos de aluminio / Aluminium frames

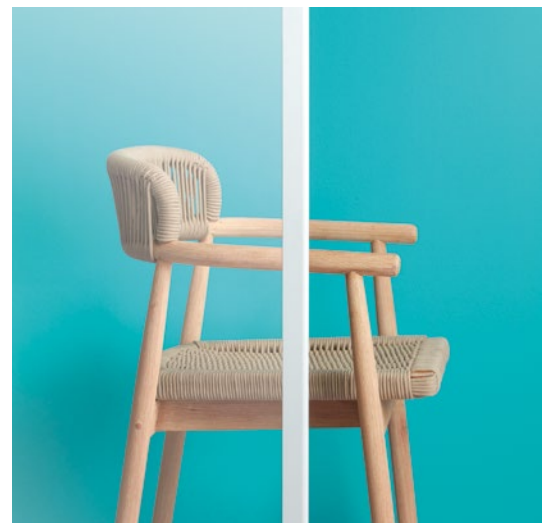
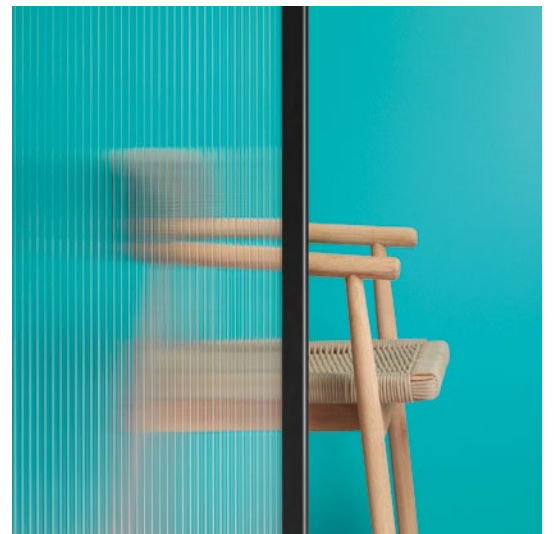
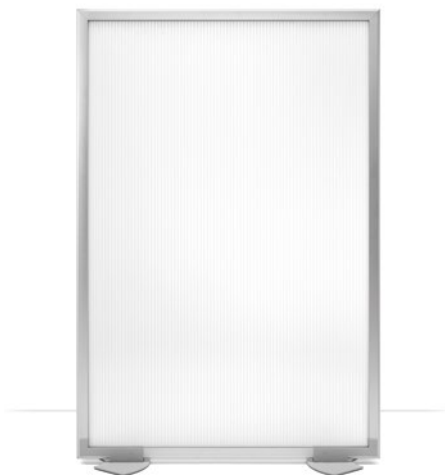

Opciones / Options

RIBBED TRANSLUCENT



1

RIBBED SEMI TRANSPARENT



2

TRANSPARENT 100%



3

MARCO PLATA / SILVER FRAME

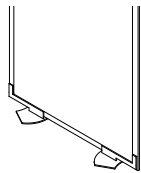

1	2	3	↕ ↔	↕	⚖	↗ ↖	↗ ↖
300/1/PX	300/1/TR	300/1/SAN	120x100 cm 47.2x39.3 in	122 cm 48 in	7 kg 15.4 Lb	2 cm 0.7 in	28 cm 11 in
300/2/PX	300/2/TR	300/2/SAN	150x100 cm 59.05x39.3 in	152 cm 59.8 in	8 kg 17.6 Lb		
300/3/PX	300/3/TR	300/3/SAN	180x100 cm 70.8x39.3 in	182 cm 71.6 in	9 kg 19.8 Lb		

MARCO ANTRACITA / ANTHRACITE FRAME

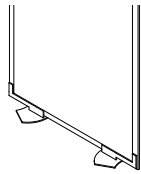

1	2	3	↕ ↔	↕	⚖	↗ ↖	↗ ↖
300/1/AN/PX	300/1/AN/TR	300/1/AN/SAN	120x100 cm 47.2x39.3 in	122 cm 48 in	7 kg 15.4 Lb	2 cm 0.7 in	28 cm 11 in
300/2/AN/PX	300/2/AN/TR	300/2/AN/SAN	150x100 cm 59.05x39.3 in	152 cm 59.8 in	8 kg 17.6 Lb		
300/3/AN/PX	300/3/AN/TR	300/3/AN/SAN	180x100 cm 70.8x39.3 in	182 cm 71.6 in	9 kg 19.8 Lb		

MARCO BLANCO / WHITE FRAME

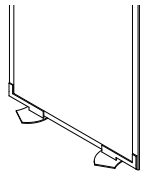

1	2	3	↕ ↔	↕	⚖	↗ ↖	↗ ↖
300/1/BL/PX	300/1/BL/TR	300/1/BL/SAN	120x100 cm 47.2x39.3 in	122 cm 48 in	7 kg 15.4 Lb	2 cm 0.7 in	28 cm 11 in
300/2/BL/PX	300/2/BL/TR	300/2/BL/SAN	150x100 cm 59.05x39.3 in	152 cm 59.8 in	8 kg 17.6 Lb		
300/3/BL/PX	300/3/BL/TR	300/3/BL/SAN	180x100 cm 70.8x39.3 in	182 cm 71.6 in	9 kg 19.8 Lb		

ACCESORIOS / ACCESORIES

REF	↕ ↔	⊙
300/K	2x5 cm 0.78x1.96 in	2
300/K/4	5x5 cm 1.96x1.96 in	4

Antibacterial Limit Screen

Marcos de aluminio / Aluminium frames

Medidas / Sizes

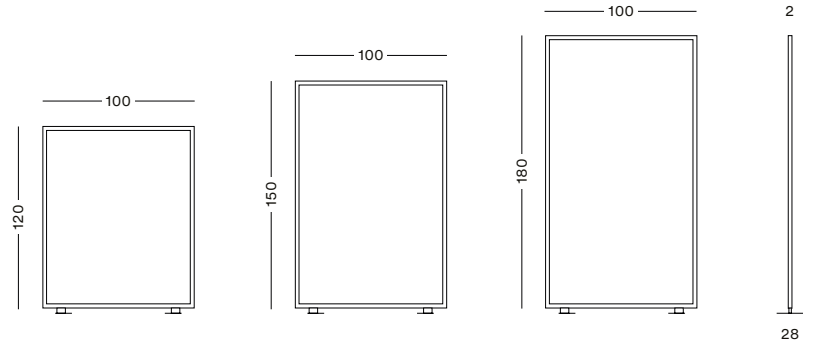

Especificaciones / Specifications



Opciones / Options

ANTIBACTERIAL GREY



ANTIBACTERIAL GRAPHITE



ANTIBACTERIAL WHITE

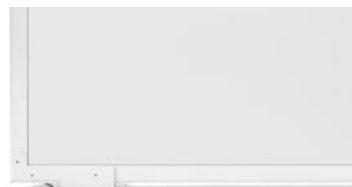

MARCO PLATA / SILVER FRAME

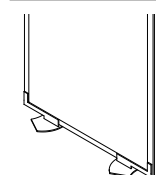

Color	Code	Dimensions (cm)	Dimensions (in)	Height (cm)	Weight (kg)	Height (cm)	Width (cm)
●	300/1/AB/GR	120x100	47.2x39.3	122	10	2	28
●	300/1/AB/GG	120x100	47.2x39.3	48	22	0.7	11
○	300/1/AB/BL	120x100	47.2x39.3	122	10	2	28
●	300/2/AB/GR	150x100	59.05x39.3	152	11	0.7	11
●	300/2/AB/GG	150x100	59.05x39.3	59.8	24.2	0.7	11
○	300/2/AB/BL	150x100	59.05x39.3	152	11	0.7	11
●	300/3/AB/GR	180x100	70.8x39.3	182	12	0.7	11
●	300/3/AB/GG	180x100	70.8x39.3	71.6	26.4	0.7	11
○	300/3/AB/BL	180x100	70.8x39.3	182	12	0.7	11

MARCO ANTRACITA / ANTHRACITE FRAME

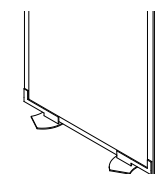

Color	Code	Dimensions (cm)	Dimensions (in)	Height (cm)	Weight (kg)	Height (cm)	Width (cm)
●	300/1/AB/GR	120x100	47.2x39.3	122	10	2	28
●	300/1/AB/GG	120x100	47.2x39.3	48	22	0.7	11
○	300/1/AB/BL	120x100	47.2x39.3	122	10	2	28
●	300/2/AB/GR	150x100	59.05x39.3	152	11	0.7	11
●	300/2/AB/GG	150x100	59.05x39.3	59.8	24.2	0.7	11
○	300/2/AB/BL	150x100	59.05x39.3	152	11	0.7	11
●	300/3/AB/GR	180x100	70.8x39.3	182	12	0.7	11
●	300/3/AB/GG	180x100	70.8x39.3	71.6	26.4	0.7	11
○	300/3/AB/BL	180x100	70.8x39.3	182	12	0.7	11

MARCO BLANCO / WHITE FRAME

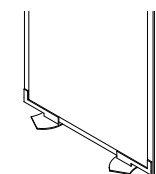

Color	Code	Dimensions (cm)	Dimensions (in)	Height (cm)	Weight (kg)	Height (cm)	Width (cm)
●	300/1/AB/GR	120x100	47.2x39.3	122	10	2	28
●	300/1/AB/GG	120x100	47.2x39.3	48	22	0.7	11
○	300/1/AB/BL	120x100	47.2x39.3	122	10	2	28
●	300/2/AB/GR	150x100	59.05x39.3	152	11	0.7	11
●	300/2/AB/GG	150x100	59.05x39.3	59.8	24.2	0.7	11
○	300/2/AB/BL	150x100	59.05x39.3	152	11	0.7	11
●	300/3/AB/GR	180x100	70.8x39.3	182	12	0.7	11
●	300/3/AB/GG	180x100	70.8x39.3	71.6	26.4	0.7	11
○	300/3/AB/BL	180x100	70.8x39.3	182	12	0.7	11

ACCESORIOS / ACCESSORIES

Image	REF	Dimensions (cm)	Quantity
	300/K	2x5	2
	300/K/4	5x5	4

Ribbed Acrylic Screen



Separador para divisorias en mesas fabricado en policarbonato acanalado en varios acabados de transparencia. Enmarcado con perfil de aluminio anodizado plata mate. Se sujeta al sobre de la mesa con unas pinzas metálicas graduables hasta 3,5cm de grosor. Ideal para oficinas y puestos de trabajo y disponible en 6 medidas. Limpiar con paño seco y un detergente neutro.

Desk Panel dividers made from ribbed polycarbonate in various transparency finishes. Framed with matt silver anodized aluminium profile. It is attached to the tabletop with adjustable metal clips up to 3.5cm in thick. Ideal for offices and workstations and available in 6 sizes. Clean with a dry cloth and a neutral detergent.

Panneau séparateur de table en polycarbonate ondulé disponible dans différentes finitions de transparence. Profil en aluminium anodisé argent mat. Il est fixé au dessus de la table avec des clips métalliques réglables jusqu'à 3,5 cm d'épaisseur. Idéal pour les bureaux et les postes de travail. Disponible en 6 tailles. Nettoyer avec un chiffon sec et un détergent neutre.

Divisorio per divisorii da tavolo realizzato in policarbonato millerighe in varie finiture di trasparenza. Incorniciato con profilo in alluminio anodizzato argento opaco. È fissato al piano del tavolo con clip metalliche regolabili fino a 3,5 cm di spessore. Ideale per uffici e luoghi di lavoro e disponibile in 6 misure. Pulire con un panno asciutto e un detergente neutro.

Medidas / Sizes

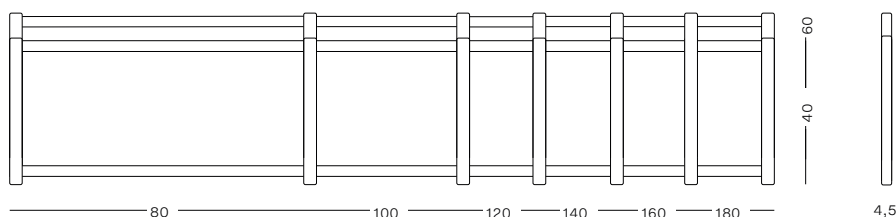

Opciones / Options

TEXTURIZAD TRANSLÚCIDO
RIBBED TRANSLUCENT

TEXTURIZADO SEMI TRANSPARENTE
RIBBED SEMI TRANSPARENT

100% TRANSPARENTE
TRANSPARENT 100%



1



2



3

→ ←

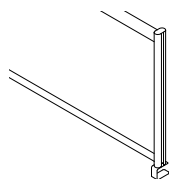

1

SEP/PX/40/80

SEP/PX/40/100

SEP/PX/40/120

SEP/PX/40/140

SEP/PX/40/160

SEP/PX/40/180

2

SEP/PX/40/80/TR

SEP/PX/40/100/TR

SEP/PX/40/120/TR

SEP/PX/40/140/TR

SEP/PX/40/160/TR

SEP/PX/40/180/TR

3

SEP/SAN/40/80

SEP/SAN/40/100

SEP/SAN/40/120

SEP/SAN/40/140

SEP/SAN/40/160

SEP/SAN/40/180



40x80 cm

15.7x31.4 in

40x100 cm

15.7x39.3 in

40x120 cm

15.7x47.2 in

40x140 cm

15.7x55.1 in

40x160 cm

15.7x62.9 in

40x180 cm

15.7x70.8 in



4 Kg

8.8 Lb

4,5 Kg

9.9 Lb

5 Kg

11 Lb

5,5 Kg

12 Lb

6 Kg

13.2 Lb

6,5 Kg

14.3 Lb

4,5 cm
1.8 in

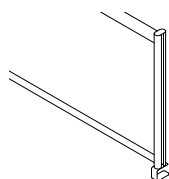

1

SEP/PX/60/80

SEP/PX/60/100

SEP/PX/60/120

SEP/PX/60/140

SEP/PX/60/160

SEP/PX/60/180

2

SEP/PX/60/80/TR

SEP/PX/60/100/TR

SEP/PX/60/120/TR

SEP/PX/60/140/TR

SEP/PX/60/160/TR

SEP/PX/60/180/TR

3

SEP/SAN/60/80

SEP/SAN/60/100

SEP/SAN/60/120

SEP/SAN/60/140

SEP/SAN/60/160

SEP/SAN/60/180



60x80 cm

23.6x31.4 in

60x100 cm

23.6x39.3 in

60x120 cm

23.6x47.2 in

60x140 cm

23.6x55.1 in

60x160 cm

23.6x62.9 in

60x180 cm

23.6x70.8 in



6 Kg

13.2 Lb

6,5 Kg

14.3 Lb

7 Kg

15.4 Lb

7,5 Kg

16.5 Lb

8 Kg

17.6 Lb

8,5Kg

18.7 Lb

Acoustic

PFA Acoustic Panel - PFA Paneles Acústicos	144
Screen Acoustic Panel - Pantallas Acústicas	148
PET Forms - Configurable PET	152
Suspended Panels - Paneles Suspendidos	154
Round Suspended Panels - Paneles Suspendidos Circulares	156
PET Onda - PET Onda	158
Star Panel - Panel Estrella	160
Circle Panel - Panel Circular	162
Accessories - Accesorios	164



El silencio es un bien preciado en las oficinas, restaurantes y espacios tanto públicos como privados. Somos conscientes que el sonido es necesario, pero minimizar su impacto en estos entornos caóticos, es una necesidad que desde Planning Sisplamo hemos decidido trabajar para conseguir un mejor ambiente que mantenga una armonía y reduzca la reverberación y por consiguiente un mejor bienestar entre los usuarios. La calma genera felicidad en los puestos de trabajo y relajación en esos espacios gastronómicos que tanto apreciamos y compartimos.

Le silence est un atout précieux dans les bureaux, les restaurants et les espaces publics ou privés. Nous sommes conscients que le son est nécessaire, mais pour minimiser son impact dans ces environnements chaotiques, Planning Sisplamo a décidé de travailler pour obtenir un meilleur environnement qui maintient l'harmonie et réduit la réverbération et donc un meilleur bien-être parmi les utilisateurs. . Le calme génère le bonheur au bureau et la détente dans ces espaces gastronomiques que nous apprécions et partageons tant.

Silence is a precious asset in offices, restaurants, and both public and private places. We are aware that sound is necessary, but to minimize its impact in these chaotic environments, it is a necessity. At Planning Sisplamo we have decided to work to achieve a better environment that maintains harmony and reduces reverberation and therefore better well-being among users. Calm generates happiness in the workplace and relaxation in those gastronomic places that we appreciate enjoy and share so much.

Il silenzio è un bene prezioso negli uffici, nei ristoranti e negli spazi pubblici e privati. Siamo consapevoli che il suono è necessario, ma minimizzare il suo impatto in questi ambienti caotici è una necessità su cui Planning Sisplamo ha deciso di lavorare per ottenere un ambiente migliore che mantenga l'armonia e riduca il riverbero, migliorando così il benessere degli utenti. La calma genera felicità nei luoghi di lavoro e relax in quegli spazi gastronomici che tanto apprezziamo e condividiamo.

PFA Acoustic Panel

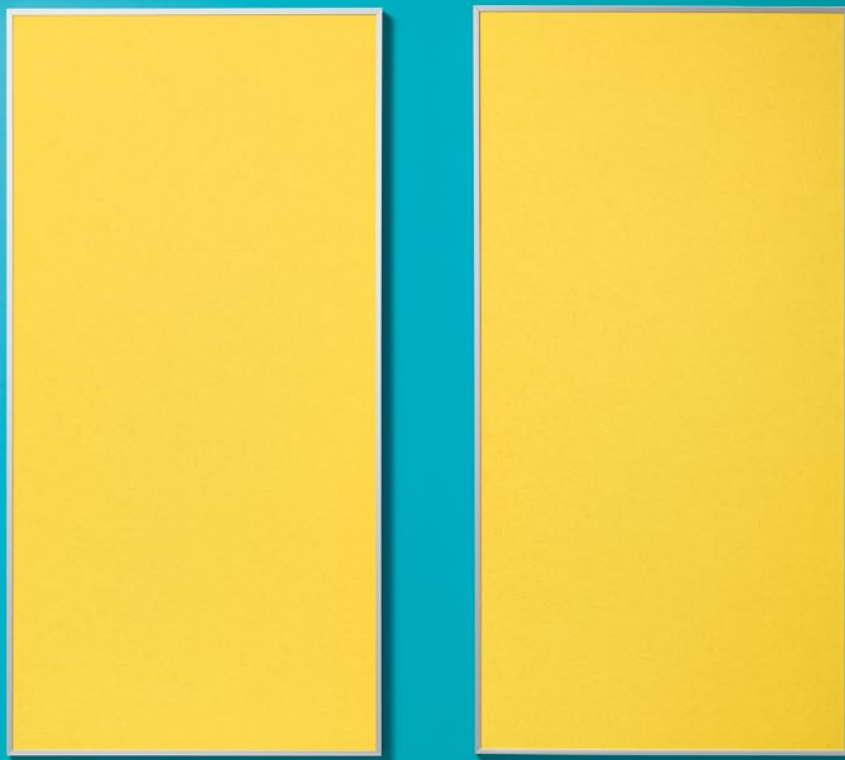

Panel fonoabsorbente enmarcado con perfil de aluminio Slim anodizado en color plata mate. Fabricado con alto porcentaje de material reciclado: 60% fibras de poliéster reciclado de botellas de plástico PET y 40% de nuevas fibras de poliéster. Propiedades acústicas: alpha m: 0,25. NRC: 0,30. Grosor de PET 0,9 mm. Disponible en 18 colores. Permite colocar notas y avisos mediante agujas o chinchetas.

Sound absorbing panel framed with anodized Slim aluminium profile in matt silver colour. Made with a high percentage of recycled material: 60% recycled polyester fibers from PET plastic bottles and 40% from new polyester fibers. Acoustic properties: alpha m: 0.25. NRC: 0.30. 0.9mm PET thickness. Available in 18 colours. It allows you to place notes and reminders using thumb tacks or pins.

Panneau acoustique phono-absorbant encadré d'un fin profil en aluminium anodisé de couleur argent mat. Fabriqué avec un pourcentage élevé de matériaux recyclés: 60% de fibres de polyester recyclées à partir de bouteilles en plastique PET et 40% de nouvelles fibres de polyester. Propriétés acoustiques: alpha m: 0,25. NRC: 0,30. Epaisseur du PET 0,9 mm. Disponible en 18 couleurs. Il permet de placer des notes et des avis à l'aide de punaises ou d'épingles.

Pannello fonoassorbente incorniciato da un profilo in alluminio anodizzato Slim di colore argento opaco. Realizzato con un'alta percentuale di materiale riciclato: 60% di fibre di poliestere riciclate da bottiglie di plastica PET e 40% di fibre di poliestere nuove. Proprietà acustiche: alfa m: 0,25. NRC: 0,30. Spessore del PET 0,9 mm. Disponibile in 18 colori. Permette di apporre note e promemoria utilizzando puntine o spille.

Medidas / Sizes

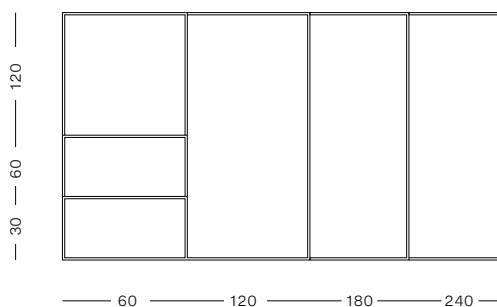

Especificaciones / Specifications



Colores / Colours

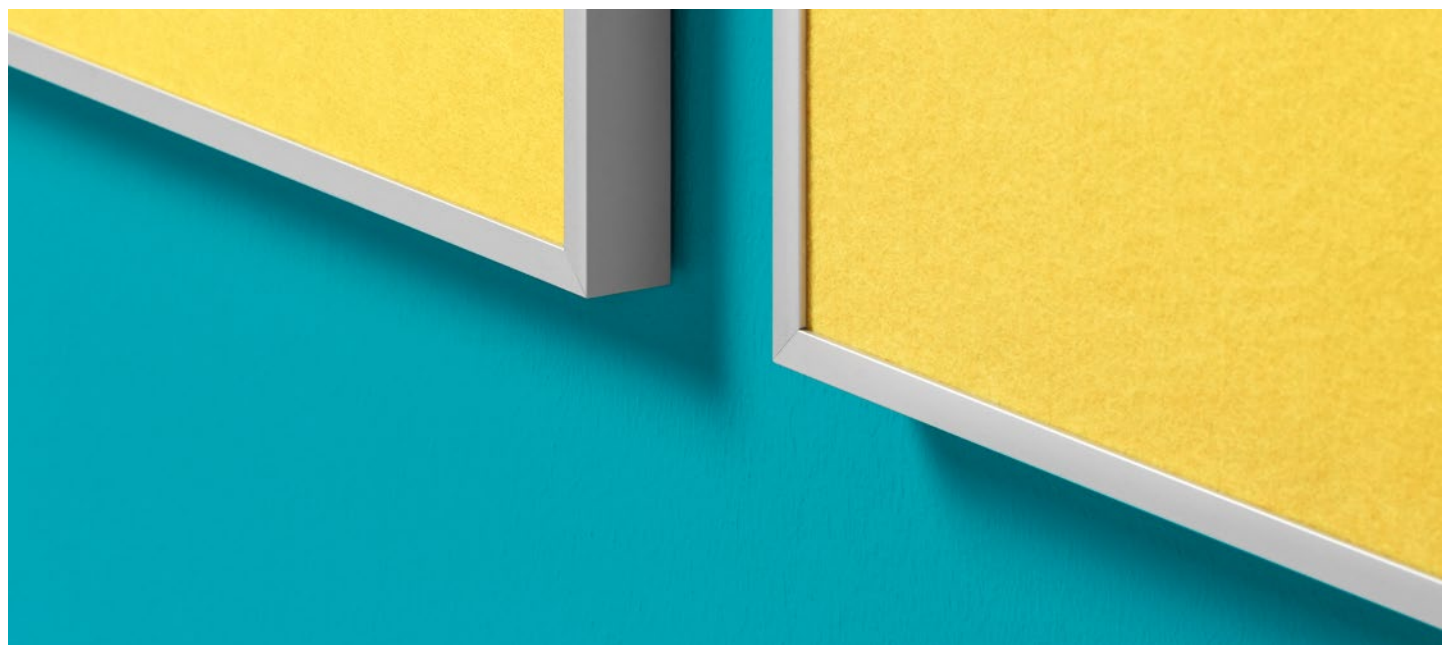

PFA Acoustic Panel

Marcos de aluminio / Aluminium frames

Sin marco / No frame

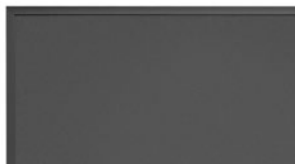
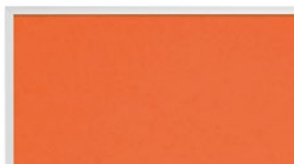

PARED / WALL

CON MARCO / WITH FRAME



PARED / WALL	CON MARCO / WITH FRAME			COLORES / COLOURS		↕ ↔	👤	ALPHA M	2,3 cm 0.9 in
	●	●	○	/BL	/AZO				
	PFA/1/PL	PFA/AN/1	PFA/BL/1	/BL	/AZO	30x60 cm 11.8x23.6 in	0,8 Kg 1.7 Lb	0,25	
	PFA/2/PL	PFA/AN/2	PFA/BL/2	/GR	/AZ	60x60 cm 23.6x23.6 in	1,4 Kg 3 Lb	0,25	
	PFA/3/PL	PFA/AN/3	PFA/BL/3	/AR	/AZC	60x120 cm 23.6x47.2 in	2,4 Kg 5.2 Lb	0,25	
	PFA/4/PL	PFA/AN/4	PFA/BL/4	/BE	/VDC	120x120 cm 47.2x47.2 in	4,2 Kg 9.2 Lb	0,25	
	PFA/5/PL	PFA/AN/5	PFA/BL/5	/AM	/VD	120x180 cm 47.2x70.8 in	6,7 Kg 14.2 Lb	0,25	
	PFA/6/PL	PFA/AN/6	PFA/BL/6	/NJ	/NG	120x240 cm 47.8x94.4 in	8,5 Kg 18.7 Lb	0,25	

PARED / WALL

SIN MARCO / WITHOUT FRAME



PARED / WALL	REF	COLORES / COLOURS		↕ ↔	👤	ALPHA M	0,9 cm 0.3 in
		/BL	/AZO				
	PFA/1	/BL	/AZO	30x60 cm 11.8x23.6 in	0,2 Kg 0.4 Lb	0,25	
	PFA/2	/GR	/AZ	60x60 cm 23.6x23.6 in	0,3 Kg 0.7 Lb	0,25	
	PFA/3	/AR	/AZC	60x120 cm 23.6x47.2 in	0,7 Kg 1.7 Lb	0,25	
	PFA/4	/BE	/VDC	120x120 cm 47.2x47.2 in	1,3 Kg 3 Lb	0,25	
	PFA/5	/AM	/VD	120x180 cm 47.2x70.8 in	1,9 Kg 4.2 Lb	0,25	
	PFA/6	/NJ	/NG	120x240 cm 47.8x94.4 in	2,7 Kg 6 Lb	0,25	

ACCESORIOS / ACCESSORIES



ACC/PFA/03
Kit de suspensión de 2m
Suspension kit 2m
Kit de suspension 2m
Kit sospensione 2m



ACC/PFA/04
Adhesivo de pared / Techo
Adhesive wall / Roof
Adhésif mur / Plafond
Adesivo da parete / soffitto

Soporte T / T Support



COLORES / COLOURS

- /GR
- /AN
- /BL



SOPORTE / SUPPORT

MEDIDAS / SIZES



●	●	○	↕ ↔	↕	7 Kg	53 cm
770/1	770/1/AN	770/1/BL	60x120 cm 39.3x47.2 in	174 cm 68,5 in	15.4 Lb	20.9 in
770/1	770/1/AN	770/1/BL	120x120 cm 47.2x47.2 in			
770/1	770/1/AN	770/1/BL	120x180 cm 47.2x70.8 in			

Soporte Y2 / Y2 Support



COLORES / COLOURS

- /GR
- /AN
- /BL



SOPORTE / SUPPORT

MEDIDAS / SIZES



●	●	○	↕ ↔	↕	53 cm
Y2/80/R	Y2/80/R/AN	Y2/80/R/BL	80x100 cm 31.5x39.3 in	173 cm 68.1 in	20.9 in
Y2/120/R	Y2/120/R/AN	Y2/120/R/BL	100x120 cm 39.3x47.2 in		
Y2/150/R	Y2/150/R/AN	Y2/150/R/BL	100x150 cm 39.3x60 in		
Y2/200/R	Y2/200/R/AN	Y2/200/R/BL	120x200 cm 47.2x78.7 in		
Y2/250/R	Y2/250/R/AN	Y2/250/R/BL	120x250 cm 47.2x96.7 in		

MÁS DETALLES SOBRE EL SOPORTE / MORE DETAILS ABOUT THE SUPPORT

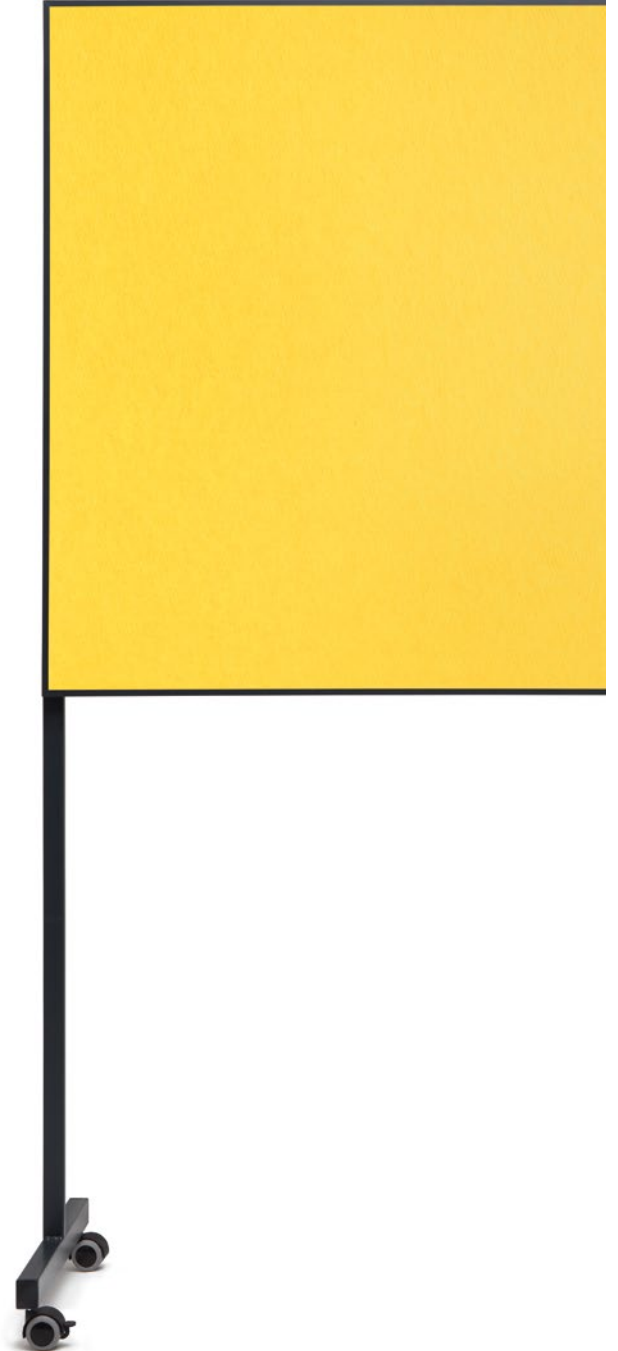
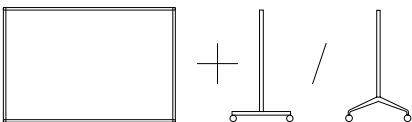

Screen Acoustic Panel



Separador fonoabsorbente para divisorias en mesas. Enmarcado con perfil de aluminio anodizado plata mate y panel con alto porcentaje de PET reciclado: 60% fibras de poliéster reciclado de botellas de plástico y 40% de nuevas fibras de poliéster. Propiedades acústicas: alpha m: 0,25. NRC: 0,30. Grosor de PET 0,9 mm. Disponible en 18 colores.

Sound absorbing panels for table dividers. Framed with a matt silver anodized aluminium profile these panels have a high percentage of recycled PET: 60% recycled polyester fibers from plastic bottles and 40% from new polyester fibers. Acoustic properties: alpha m: 0.25. NRC: 0.30. 0.9mm PET thickness. Available in 18 colours.

Panneau acoustique phono-absorbant pour séparer les tables. Composé d'un profil en aluminium anodisé argent mat et d'un panneau avec un pourcentage élevé de PET recyclé: 60% de fibres de polyester recyclées à partir de bouteilles en plastique et 40% de nouvelles fibres de polyester. Propriétés acoustiques: alpha m: 0,25. NRC: 0,30. Epaisseur du PET de 0,9 mm. Disponible en 18 couleurs.

Pannelli fonoassorbenti per divisori di tavoli. Incorniciati da un profilo in alluminio anodizzato argento opaco, questi pannelli hanno un'alta percentuale di PET riciclato: 60% di fibre di poliestere riciclate da bottiglie di plastica e 40% di fibre di poliestere nuove. Proprietà acustiche: alfa m: 0,25. NRC: 0,30. Spessore del PET 0,9 mm. Disponibile in 18 colori.

Medidas / Sizes

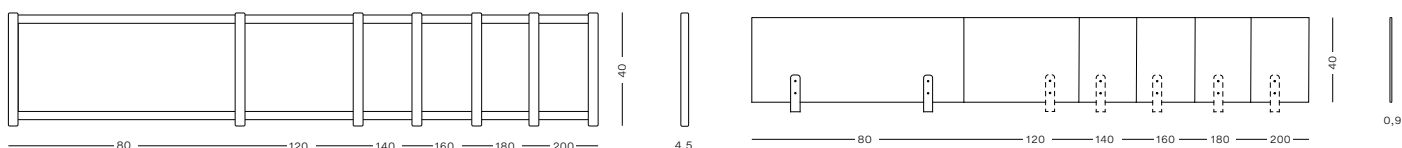

Especificaciones / Specifications



Colores / Colours

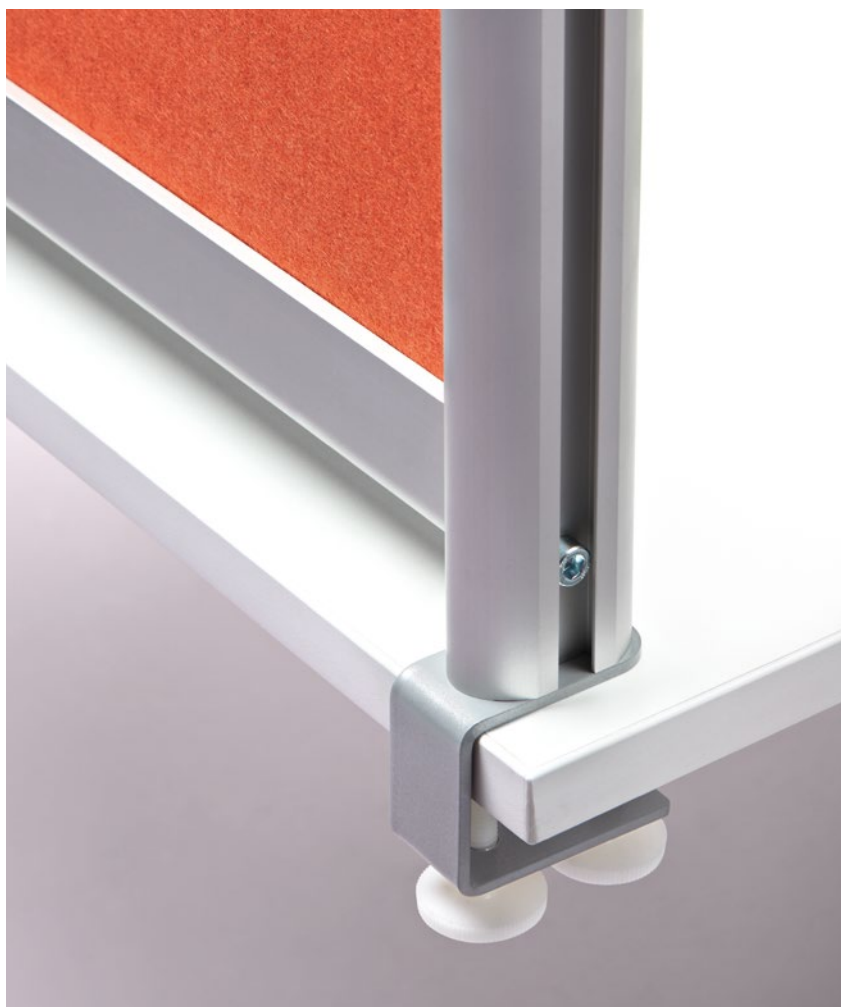
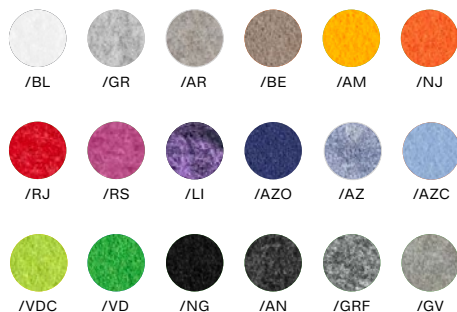

Screen Acoustic Panel

Marcos de aluminio / Aluminium frames



SCREEN CON MARCO / WITH FRAME

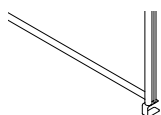

REF

SEP/FA/80
SEP/FA/120
SEP/FA/140
SEP/FA/160
SEP/FA/180
SEP/FA/200

COLORES / COLOURS

● /BL	● /AZO
● /GR	● /AZ
● /AR	● /AZC
● /BE	● /VDC
● /AM	● /VD
● /NJ	● /NG
● /RJ	● /AN
● /RS	● /GRF
● /LI	● /GV



40x80 cm
15.7x31.4 in
40x120 cm
15.7x47.2 in
40x140 cm
15.7x55.1 in
40x160 cm
15.7x62.9 in
40x180 cm
15.7x70.8 in
40x200 cm
15.7x78.7 in



2,7 Kg
5.5 Lb
3,9 Kg
8.5 Lb
4,5 Kg
9.9 Lb
5 Kg
11 Lb
6 Kg
13.2 Lb
6,5 Kg
14.3 Lb

ALPHA M

0,25
0,25
0,25
0,25
0,25
0,25
0,25
0,25



4,5 cm
1.7 in

Sin marco / No frame



SCREEN SIN MARCO / WITHOUT FRAME

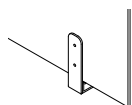

REF

SEP/FP/80
SEP/FP/120
SEP/FP/140
SEP/FP/160
SEP/FP/180
SEP/FP/200

COLORES / COLOURS

● /BL	● /AZO
● /GR	● /AZ
● /AR	● /AZC
● /BE	● /VDC
● /AM	● /VD
● /NJ	● /NG
● /RJ	● /AN
● /RS	● /GRF
● /LI	● /GV



40x80 cm
15.7x31.4 in
40x120 cm
15.7x47.2 in
40x140 cm
15.7x55.1 in
40x160 cm
15.7x62.9 in
40x180 cm
15.7x70.8 in
40x200 cm
15.7x78.7 in



0,7 Kg
1.6 Lb
0,9 Kg
1.9 Lb
1 Kg
2,3 Lb
1,2 Kg
2.6 Lb
1,3 Kg
3 Lb
1,5 Kg
3.3 Lb

ALPHA M

0,25
0,25
0,25
0,25
0,25
0,25
0,25
0,25



0,9 cm
0.3 in

Medidas pinzas / Grippers sizes

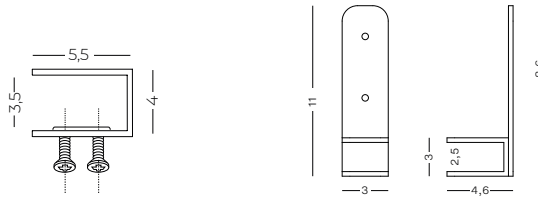

REF $\updownarrow \leftrightarrow$
 EP/PZ/3 11x3x4,6 cm KIT 2 CLAMPS
 15.7x31.4 in

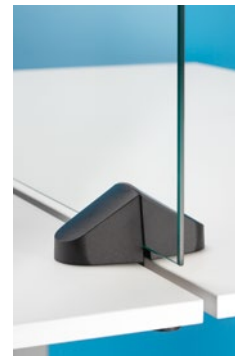

COMPLET $\rightarrow \leftarrow$

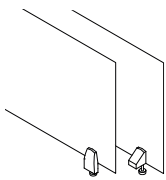

END TABLE
 EP/MPS1/60/91
 EP/MPS1/75/91

INTERMEDIATE TABLE
 EP/MPS2/60/91
 EP/MPS2/75/91

$\updownarrow \leftrightarrow$
 60x91 cm
 23.6x35.8 in
 75x91 cm
 29.5x35.8 in

\updownarrow
 9 Kg
 19.8 Lb
 9,5 Kg
 21 Lb

0.6 cm
 0.2 in

ONLY CLAMP $\rightarrow \leftarrow$



END TABLE
 EP/PZ/1

\updownarrow
 1,5 to 3,4 cm
 0.5 to 1.3 in

\updownarrow
 0,2 Kg
 0.4 Lb

2 to 2,8 cm
 0.78 to 1.1 in



INTERMEDIATE TABLE
 EP/PZ/2

\updownarrow
 1,5 to 3,5 cm
 0.5 to 1.4 in

\updownarrow
 0,2 Kg
 0.4 Lb

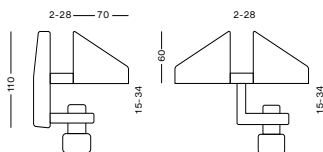

END TABLE

INTERMEDIATE TABLE



PET Forms



Piezas de PET configurables para pegar a la pared según necesidad. Panel con alto porcentaje de PET reciclado 60% de botellas de plástico PET y 40% de nuevas fibras de poliéster. Propiedades acústicas: alpha m: 0,25. NRC: 0,30. Grosor de PET 0,9 mm. Disponible en 18 colores. Permite colocar notas y avisos mediante chinchetas o agujas.

Configurable PET pieces for wall attachment as needed. Panel with a high percentage of recycled PET, 60% from PET plastic bottles, and 40% from new polyester fibers. Acoustic properties: alpha m: 0.25. NRC: 0.30. PET thickness 0.9 mm. Available in 18 colors. Allows for attaching notes and announcements with pushpins or needles.

Pièces de PET configurables pour fixer au mur selon les besoins. Panneau avec un pourcentage élevé de PET recyclé, soit 60% de bouteilles en plastique PET et 40% de nouvelles fibres de polyester. Propriétés acoustiques : alpha m : 0,25. NRC : 0,30. Épaisseur de PET de 0,9 mm. Disponible en 18 couleurs. Permet de fixer des notes et des annonces avec des punaises ou des aiguilles.

Pezzi di PET configurabili per attaccare al muro secondo necessità. Pannello con un alto percentuale di PET riciclato, il 60% da bottiglie di plastica PET e il 40% da nuove fibre di poliestere. Proprietà acustiche: alpha m: 0,25. NRC: 0,30. Spessore del PET 0,9 mm. Disponibile in 18 colori. Consente di attaccare note e avvisi con puntine o spilli.

Especificaciones / Specifications

Medidas / Sizes

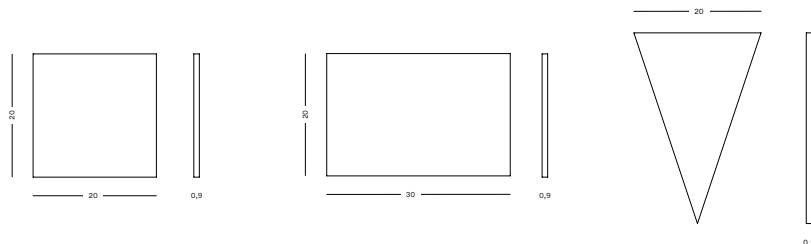

Colores / Colours

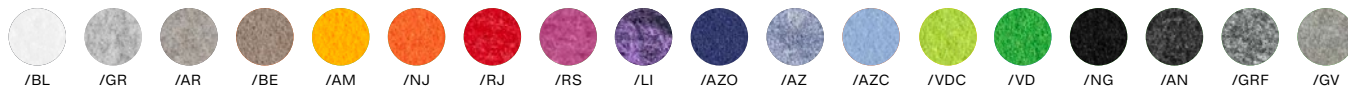

Data

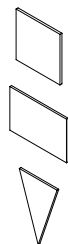

REF	COLORES / COLOURS	↕ ↔	🏠	↗ ↖
PET/CU/01	/BL /GR /AR /BE /AM /NJ /RJ /RS /LI /AZO /AZ /AZC /VDC /VD /NG /AN /GRF /GV	20x20 cm 7.87x7.87 in	0.09 Kg 0.198 Lb	0.9 cm 0.35 in
PET/RE/01	/RJ /RS /LI /AZO /AZ /AZC /VDC /VD /NG /AN /GRF /GV	20x30 cm 7.87x11.8 in	0.120 Kg 0.264 Lb	0.9 cm 0.35 in
PET/TR/01		30x20 cm 11.8x7.87 in	0.100 Kg 0.220 Lb	0.9 cm 0.35 in

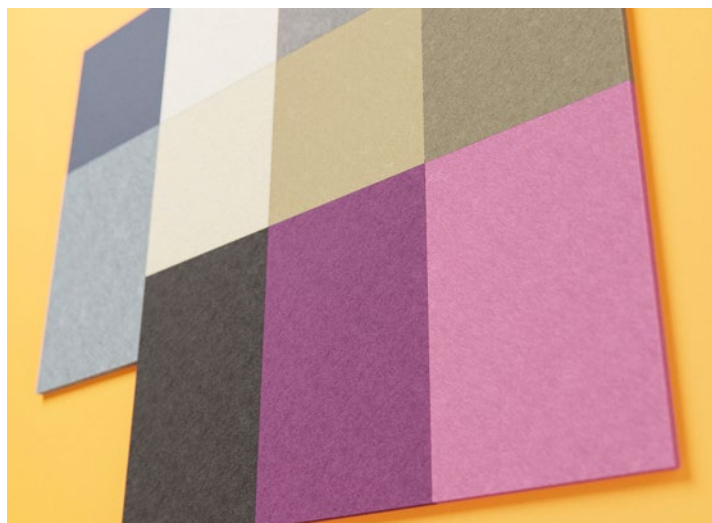

Suspended Panels



Paneles de PET reciclado para suspensión de techo. Panel con alto porcentaje de PET reciclado 60% de botellas de plástico PET y 40% de nuevas fibras de poliéster. Propiedades acústicas: alpha m: 0,25. NRC: 0,30. Grosor de PET 0,9 mm. Disponible en 18 colores.

Recycled PET panels for ceiling suspension. Panel with a high percentage of recycled PET, 60% from PET plastic bottles, and 40% from new polyester fibers. Acoustic properties: alpha m: 0.25. NRC: 0.30. PET thickness 0.9 mm. Available in 18 colors.

Panneaux en PET recyclé pour suspension au plafond. Panneau avec un pourcentage élevé de PET recyclé, soit 60% de bouteilles en plastique PET et 40% de nouvelles fibres de polyester. Propriétés acoustiques : alpha m : 0,25. NRC : 0,30. Épaisseur de PET de 0,9 mm. Disponible en 18 couleurs.

Pannelli in PET riciclato per sospensione a soffitto. Pannello con un alto percentuale di PET riciclato, il 60% da bottiglie di plastica PET e il 40% da nuove fibre di poliestere. Proprietà acustiche: alpha m: 0,25. NRC: 0,30. Spessore del PET 0,9 mm. Disponibile in 18 colori.

Especificaciones / Specifications



Medidas / Sizes

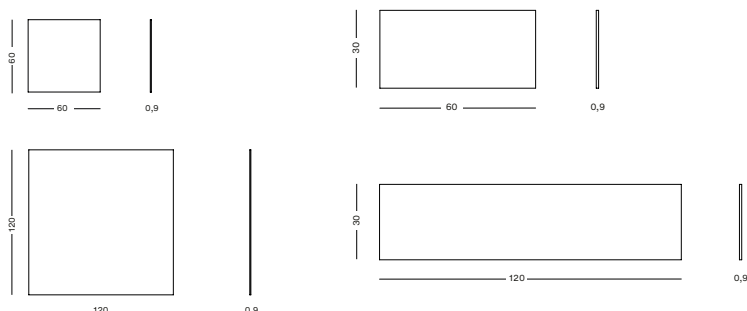

Colores / Colours

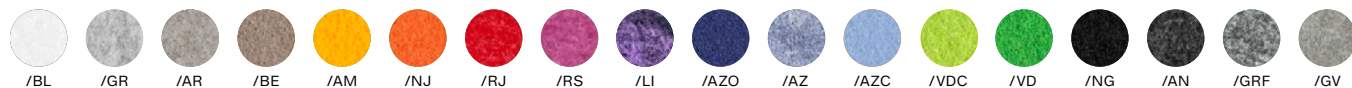

Data

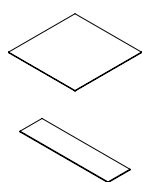

REF	COLORES / COLOURS												
PET/IS/01	/BL	/GR	/AR	/BE	/AM	/NJ							
PET/IS/02	/RJ	/RS	/LI	/AZO	/AZ	/AZC							
PET/SU/01	/VDC	/VD	/NG	/AN	/GRF	/GV							
PET/SU/02													

↕ ↔	⚖	↗ ↖
60x60 cm 23.6x23.6 in	0.712 Kg 1.569 Lb	0.9 cm 0.35 in
120x120 cm 47.2x47.2 in	2.85 Kg 6.283 Lb	0.9 cm 0.35 in
30x60 cm 11.8x23.6 in	0.356 Kg 0.784 Lb	0.9 cm 0.35 in
30x120 cm 11.8x47.2 in	0.712 Kg 1.569 Lb	0.9 cm 0.35 in



Round Suspended Panels



Panels de PET reciclado para suspensión de techo. Panel con alto porcentaje de PET reciclado 60% de botellas de plástico PET y 40% de nuevas fibras de poliéster. Propiedades acústicas: alpha m: 0,25. NRC: 0,30. Grosor de PET 0,9 mm. Disponible en 18 colores.

Recycled PET panels for ceiling suspension. Panel with a high percentage of recycled PET, 60% from PET plastic bottles, and 40% from new polyester fibers. Acoustic properties: alpha m: 0.25. NRC: 0.30. PET thickness 0.9 mm. Available in 18 colors.

Panneaux en PET recyclé pour suspension au plafond. Panneau avec un pourcentage élevé de PET recyclé, soit 60% de bouteilles en plastique PET et 40% de nouvelles fibres de polyester. Propriétés acoustiques : alpha m : 0,25. NRC : 0,30. Épaisseur de PET de 0,9 mm. Disponible en 18 couleurs.

Pannelli in PET riciclato per sospensione a soffitto. Pannello con un alto percentuale di PET riciclato, il 60% da bottiglie di plastica PET e il 40% da nuove fibre di poliestere. Proprietà acustiche: alpha m: 0,25. NRC: 0,30. Spessore del PET 0,9 mm. Disponibile in 18 colori.

Especificaciones / Specifications

Medidas / Sizes

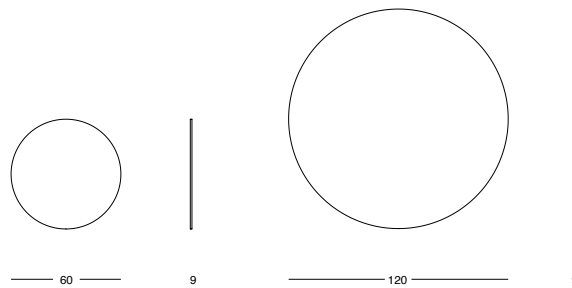

Colores / Colours



Data

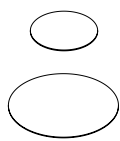

REF

PET/RD/01

PET/RD/02

COLORES / COLOURS

/BL

/GR

/AR

/BE

/AM

/NJ

/RJ

/RS

/LI

/AZO

/AZ

/AZC

/VDC

/VD

/NG

/AN

/GRF

/GV



Ø60 cm

Ø23.6 in

Ø120 cm

Ø47.2 in



0.600 Kg

1.322 Lb

2.42 Kg

5.335 Lb



0.9 cm

0.35 in

0.9 cm

0.35 in

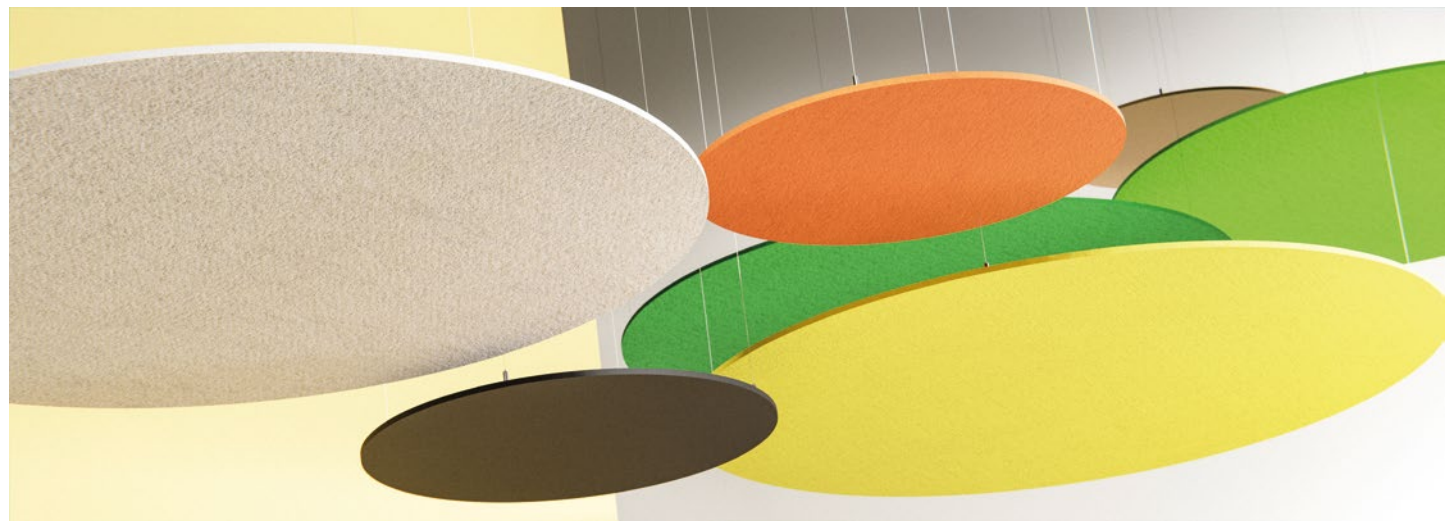

PET Onda



Paneles de PET reciclado para suspensión de techo. Panel con alto porcentaje de PET reciclado 60% de botellas de plástico PET y 40% de nuevas fibras de poliéster. Propiedades acústicas: alpha m: 0,25. NRC: 0,30. Grosor de PET 0,9 mm. Disponible en 18 colores.

Recycled PET panels for ceiling suspension. Panel with a high percentage of recycled PET, 60% from PET plastic bottles, and 40% from new polyester fibers. Acoustic properties: alpha m: 0.25. NRC: 0.30. PET thickness 0.9 mm. Available in 18 colors.

Panneaux en PET recyclé pour suspension au plafond. Panneau avec un pourcentage élevé de PET recyclé, soit 60% de bouteilles en plastique PET et 40% de nouvelles fibres de polyester. Propriétés acoustiques : alpha m : 0,25. NRC : 0,30. Épaisseur de PET de 0,9 mm. Disponible en 18 couleurs.

Pannelli in PET riciclato per sospensione a soffitto. Pannello con un alto percentuale di PET riciclato, il 60% da bottiglie di plastica PET e il 40% da nuove fibre di poliestere. Proprietà acustiche: alpha m: 0,25. NRC: 0,30. Spessore del PET 0,9 mm. Disponibile in 18 colori.

Especificaciones / Specifications

Medidas / Sizes

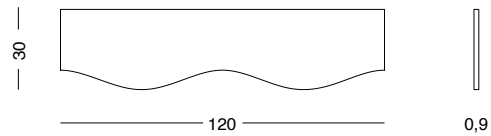

Colores / Colours



Data



REF

PET/ON/01

PET/ON/02

COLORES / COLOURS

/BL /GR /AR /BE /AM /NJ
 /RJ /RS /LI /AZO /AZ /AZC
 /VDC /VD /NG /AN /GRF /GV



30x60 cm
11.8x23.6 in

30x120 cm
11.8x47.2 in



0.034 Kg
0.076 Lb

0.690 Kg
1.521 Lb



0.9 cm
0.35 in

0.9 cm
0.35 in



Star Panel



Panel cuadrado termoformado con pliegues, fonoabsorbente fabricado en felt PET de 3mm. Material para pegar a pared y configurar la forma en cada espacio según necesidad. Disponible en 9 colores.

Square thermoformed panel with folds, sound-absorbing, made of 3mm PET felt. Material for wall attachment, allowing configuration to fit each space as needed. Available in 9 colors.

Panneau carré thermoformé avec plis, absorbant acoustique, fabriqué en feutre PET de 3 mm. Matériau à fixer au mur, permettant une configuration adaptée à chaque espace selon les besoins. Disponible en 9 couleurs.

Pannello quadrato termoformato con pieghe, fonoassorbente, realizzato in feltro PET da 3 mm. Materiale da attaccare al muro, permettendo la configurazione adatta a ogni spazio secondo le necessità. Disponibile in 9 colori.

Especificaciones / Specifications

Medidas / Sizes

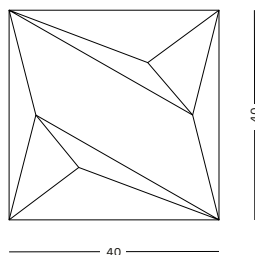
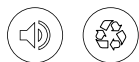

Colores / Colours



Data



REF
2300/01

COLORES / COLOURS

● /AN ● /GR ● /BE ● /AZC ● /NJ ● /AM
● /VD ● /VDM ● /VDC

↕ ↔
40x40 cm
15.7x15.7 in

⚖
0.150 Kg
0.330 Lb

✂
0.3 cm
0.11 in

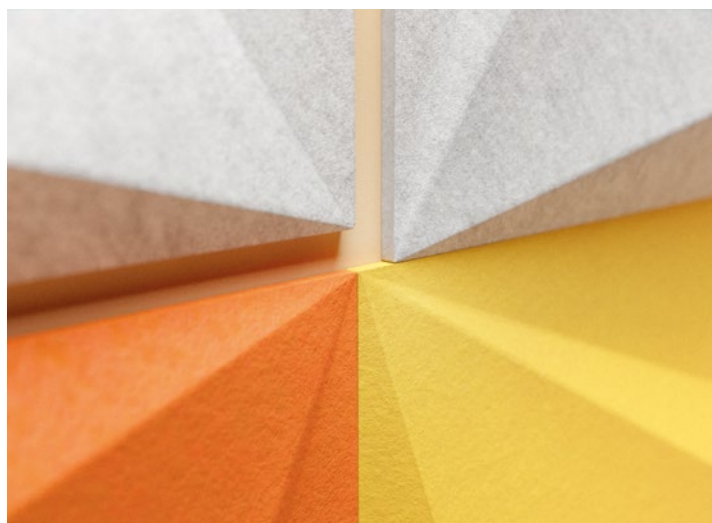

Circle Panel

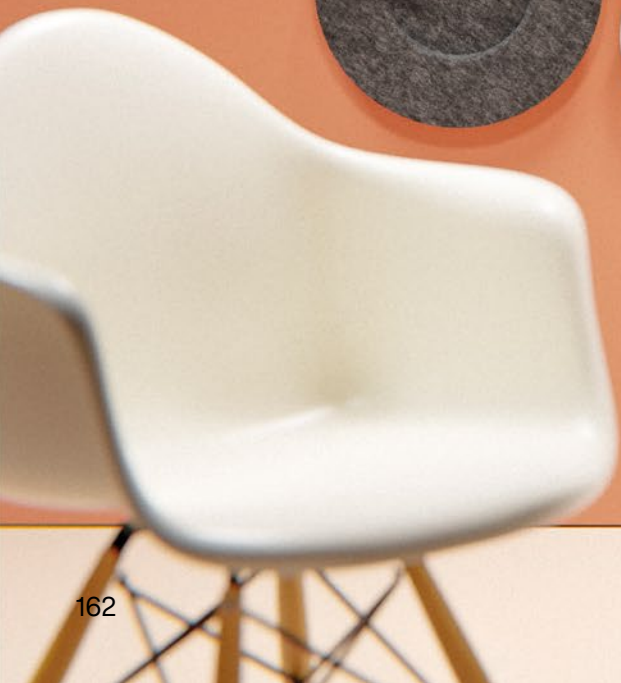

Panel redondo termoformado sobre base de plástico para dar rigidez. Material fonoabsorbente fabricado en felt PET de 3mm. Material para pegar a pared y configurar la forma en cada espacio según necesidad. Disponible en 9 colores.

Round thermoformed panel on a plastic base for added rigidity. Sound-absorbing material made of 3mm PET felt. Material for wall attachment, allowing configuration to fit each space as needed. Available in 9 colors.

Panneau rond thermoformé sur une base en plastique pour plus de rigidité. Matériau absorbant le son fabriqué en feutre PET de 3 mm. Matériau à fixer au mur, permettant une configuration adaptée à chaque espace selon les besoins. Disponible en 9 couleurs.

Pannello rotondo termoformato su una base di plastica per conferire rigidità. Materiale fonoassorbente realizzato in feltro PET da 3 mm. Materiale da attaccare al muro, permettendo la configurazione adatta a ogni spazio secondo le necessità. Disponibile in 9 colori.

Especificaciones / Specifications

Medidas / Sizes

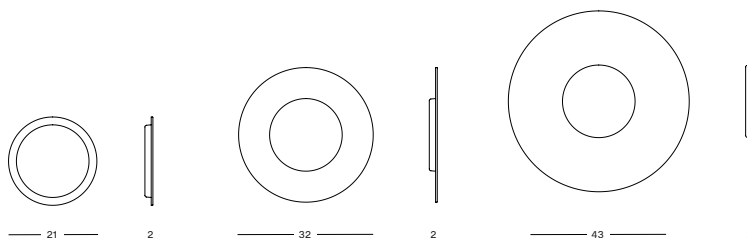
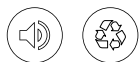

Colores / Colours

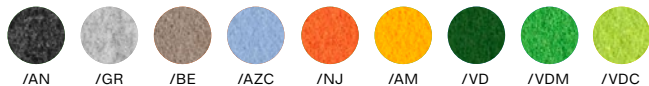

Data

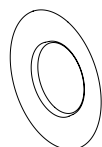

REF

2200/01

2200/02

2200/03

COLORES / COLOURS

● /AN ● /GR ● /BE ● /AZC ● /NJ ● /AM

● /VD ● /VDM ● /VDC



Ø21 cm
Ø8.26 in

Ø32 cm
Ø12.5 in

Ø43 cm
Ø16.9 in



0.076 Kg
0.167 Lb

0.115 Kg
0.253 Lb

0.155 Kg
0.341 Lb



0.4 cm
0.15 in

0.4 cm
0.15 in

0.4 cm
0.15 in



Accesorios

Kit de suspensión 2 m.
Suspension kit 2m.
Kit de suspensión 2 m.
Kit sospensione 2 m.

ACC/PFA/03



Pinza 1
Clamp 1
Pince 1
Pinza 1

EP/PZ/1



Pinza 2
Clamp 2
Pince 2
Pinza 2

EP/PZ/2



Tubo de cola (290 ml)
Glue bottle (290 ml)
Bouteille de colle (290 ml)
Tubo di colla (290 ml)

ACC/PFA/04



Kit 2 piezas sujección techo Pet 9 mm.
Kit 2 pieces ceiling fixing PET 9 mm.
Kit 2 pièces de fixation au plafond PET 9 mm.
Kit 2 pezzi fissaggio a soffitto PET 9 mm.

ACC/PFA/05



Colores

PET Felt

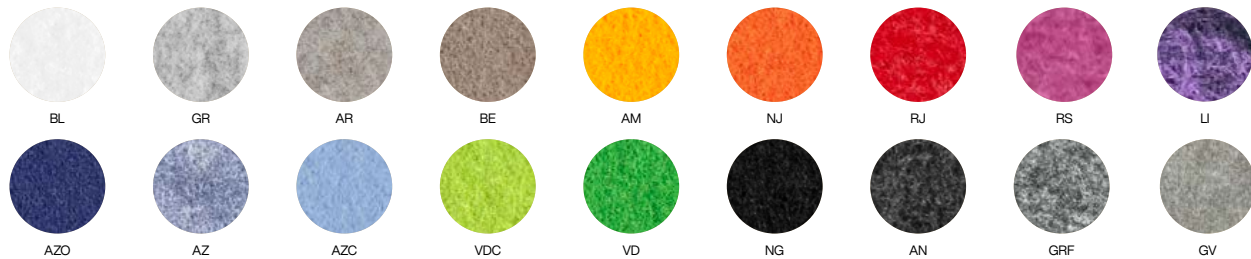

FELT colors

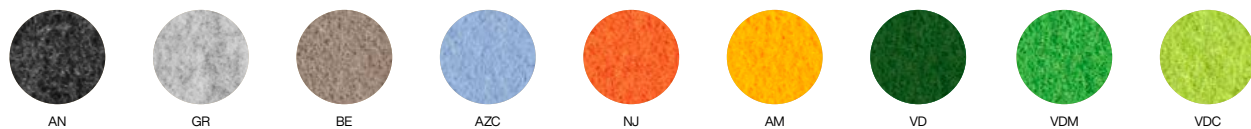



Display

Snap Frames - Expositor	168
Lecterns Snap Frames - Atril Expositor	172
Picture Hanging Rail - Riel cuelga Cuadros	176
Grid Panel - Panel Rejilla	178

Comunicar, exhibir, mostrar... debe hacerse de manera ordenada. En Planning Sisplamo queremos colaborar ofreciendo una gama de productos que no solo comuniquen o exhiban con claridad, nos hemos esforzado en lograr un producto que genere un espacio acorde a cada necesidad, un póster o anuncio, un menú en una cafetería, la delimitación de un espacio en un museo, o un portafolletos en una feria, son algunos de los complementos que ofrecemos en esta familia de productos. Pretendemos ofrecer una gama eficaz.

Communicate, exhibit, show ... should be done in an orderly manner. At Planning Sisplamo we want to collaborate by offering a range of products that not only communicate or display clearly, we have strived to achieve a product that generates an environment according to each necessity, a poster or advertisement, a menu in a restaurant, the cordoning off of an area in a museum, or a brochure holder at a fair, are some of the accessories we offer in this product family. We intend to offer an efficient range.

Communiquer, exposer, montrer ... doit se faire de manière ordonnée. Chez Planning Sisplamo nous voulons collaborer en offrant une gamme de produits qui communiquent ou affichent clairement. Nous nous sommes efforcés à réaliser un produit qui génère un espace en fonction de chaque besoin, une affiche ou une publicité, un menu dans une cafétéria, la délimitation d'un espace dans un musée, ou d'un porte-brochures lors d'une foire, sont quelques-uns des accessoires que nous proposons dans cette famille de produits. Il s'agit d'une gamme performante et efficace.

Comunicare, esporre, mostrare... deve essere fatto in modo ordinato. Noi di Planning Sisplamo vogliamo collaborare offrendo una gamma di prodotti che non solo comunichino o esponano in modo chiaro, ma ci siamo sforzati di realizzare un prodotto che generi uno spazio in base a ogni esigenza, un poster o una pubblicità, un menu in una caffetteria, la delimitazione di uno spazio in un museo o un portadepliant in una fiera, sono alcuni dei complementi che offriamo in questa famiglia di prodotti. Il nostro obiettivo è offrire una gamma efficace.

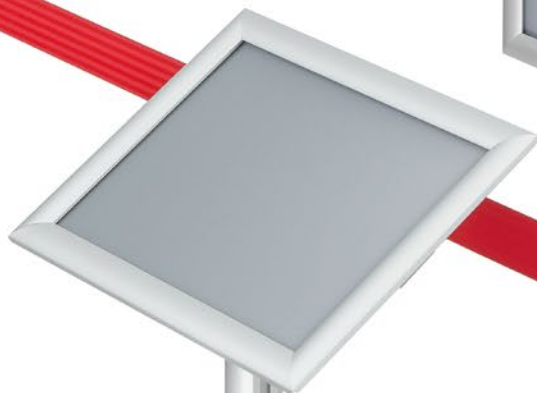

Snap Frames



Sistema de presentación de pósters, con marco abatible de aluminio anodizado en plata mate a inglete, que permite la sustitución del impreso de una manera rápida y cómoda. Disponible en opción mural y sobre soportes de aluminio con estante portafolletos u opción de soportes solo con estantes metálicos portafolletos.

Poster presentation system, with a folding frame made from matt silver anodized aluminium with a miter, which allows the substitution of the poster/notice in a quick and convenient way. Available in wall mounting option and on aluminium supports with brochure holder shelf or option of supports only with metallic brochure holder shelves.

Système de présentation d'affiches, cadre à bord rabatable en aluminium anodisé argent mat, qui permet la substitution du support de façon rapide et confortable. Disponible en version murale et sur supports en aluminium avec étagère porte-brochures ou en option supports uniquement avec étagères métalliques porte-brochures.

Sistema per la presentazione di poster, con telaio pieghevole in alluminio anodizzato argento opaco con mitra, che consente di sostituire il poster/avviso in modo rapido e pratico. Disponibile in opzione a parete e su supporti in alluminio con ripiano portadepliant o in opzione solo su supporti con ripiani portadepliant metallici.



Snap Frames

832



Medidas / Sizes

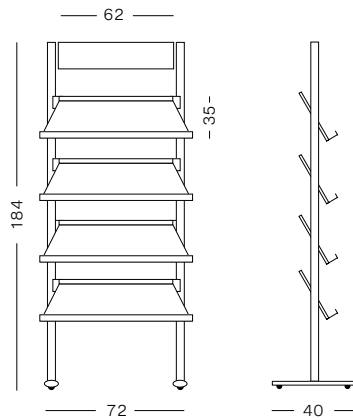

Data

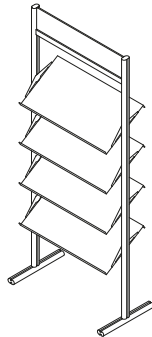

REF	↕ ↔	↔	⚖
832/4	184x72 cm 72.4x28.3 in	40 cm 15.7 in	22 Kg 48.5 Lb

2400



Medidas / Sizes

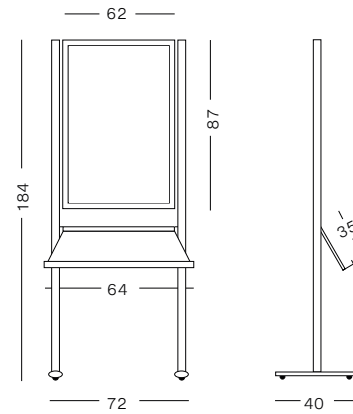

Data

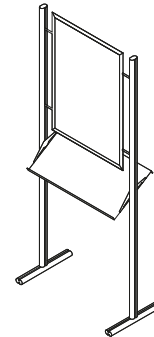

REF	↕ ↔	↔	⚖	📄
2400/IB	184x72 cm 72.4x28.3 in	40 cm 15.7 in	17 Kg 37.4 Lb	A1

850



Medidas / Sizes

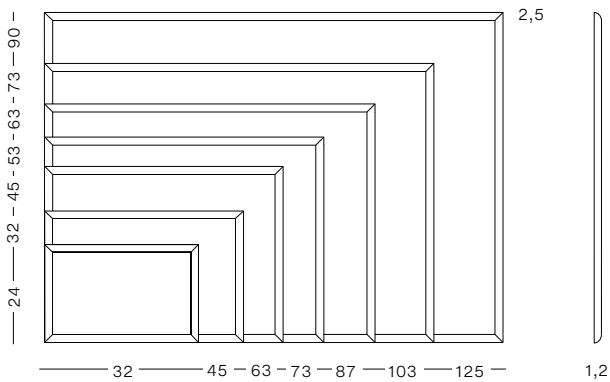

Data



REF	↕ ↔ INT.	↕ ↔ EXT.	⚖	📄	1,2 cm 0.4 in
850//M0	82x117 cm 32.2x46.06 in	89,5x124,3 cm 35.2x49 in	4 Kg 8.8 Lb	A0	
850//M1	59,4x84 cm 23.3x33 in	62,4x87,1 cm 24.5x34.2 in	2 Kg 4.4 Lb	A1	
850//M2	42x59,4 cm 16.5x23.3 in	45x62,4 cm 17.7x24.4 in	1,5 Kg 3.3 Lb	A2	
850//M3	70x100 cm 27.6x39.4 in	73x103 cm 28.7x40.5 in	3 Kg 6.6 Lb	70x100	
850//M4	50x70 cm 19.7x27.6 in	53x73 cm 20.8x28.7 in	1,7 Kg 3.7 Lb	50x70	
850//M5	42x29,7 cm 16.5x11.6 in	32,7x45 cm 12.8x17.7 in	0,7 Kg 1.5 Lb	A3	
850//M6	21x29,7 cm 8.2x11.6 in	24x32,7 cm 9.4x12.8 in	0,5 Kg 1.1 Lb	A4	



Lecterns Snap Frames



Gama de atriles expositores fijos o graduables en altura, fabricados en aluminio con marco abatible para exponer toda clase de documentos o información, catálogos, menús... El portapóster superior Din A4 y Din A3 permite adaptarse al soporte en posición vertical y horizontal y la versión graduable permite variar la inclinación de 0° a 90°.

Range of fixed or height-adjustable display stands, made from aluminium with a folding frame to display all kinds of documents or information, brochures, menus... The upper Din A4 and Din A3 poster holder allows you to change to either vertical or horizontal positions and the adjustable version allows the inclination to vary from 0° to 90°.

Gamme de présentoirs fixes ou réglables en hauteur, en aluminium avec un cadre à bord rabattable pour afficher toutes sortes de documents ou d'informations, catalogues, menus... Le porte-affiche supérieur Din A4 et Din A3 permet de s'adapter au support en position verticale et horizontale et la version réglable permet une inclinaison de 0° à 90°.

Gamma di espositori fissi o regolabili in altezza, realizzati in alluminio con telaio pieghevole per esporre tutti i tipi di documenti o informazioni, brochure, menus... Il porta poster superiore Din A4 e Din A3 consente di passare alla posizione verticale o orizzontale, mentre la versione regolabile permette di variare l'inclinazione da 0° a 90°.

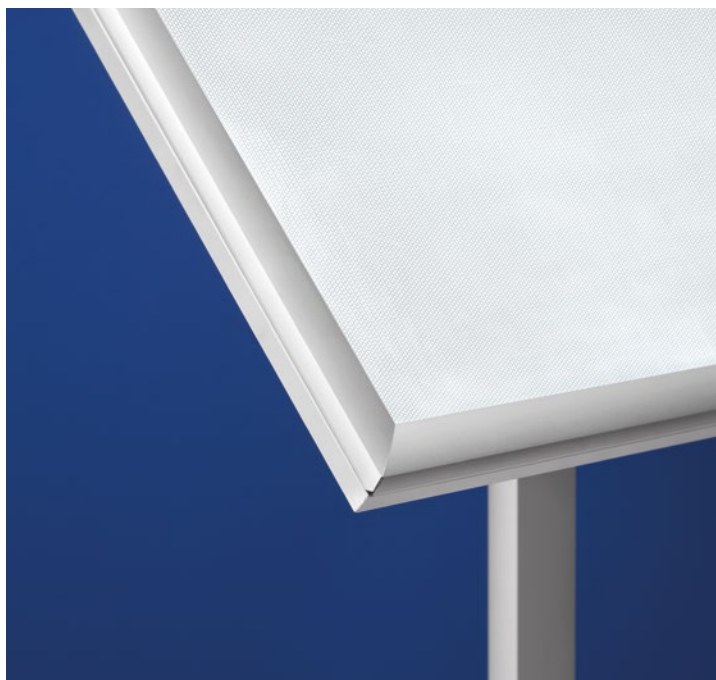
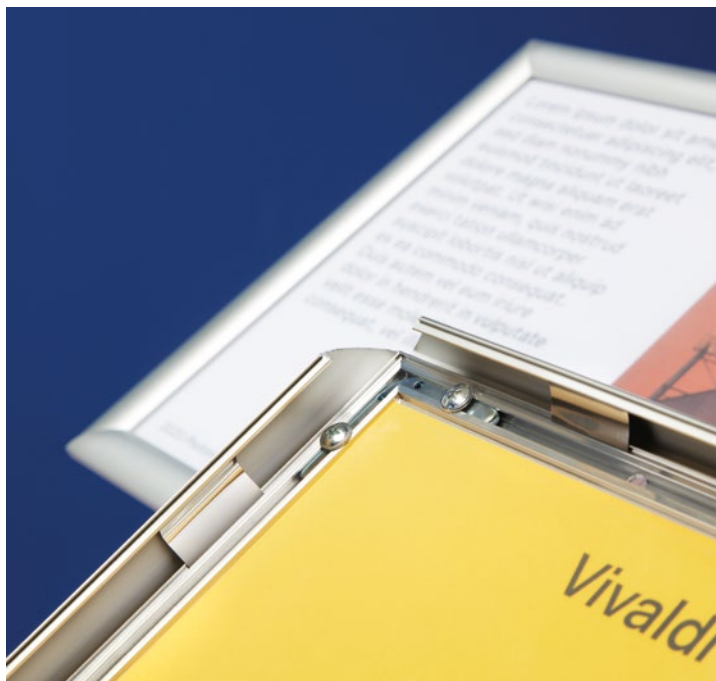

Lecterns Snap Frames

821



Medidas / Sizes

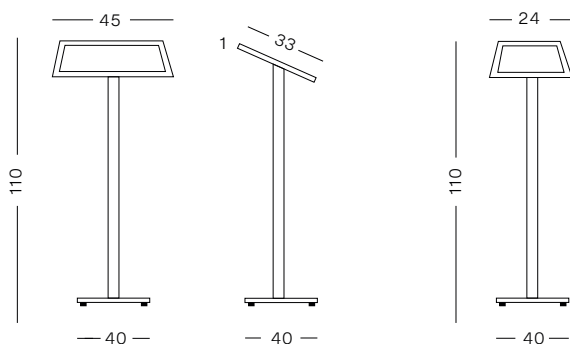

Data

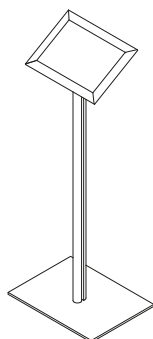
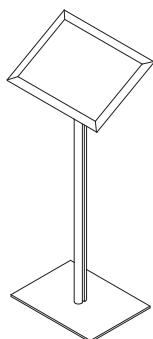

REF	↕ ↔	↔	□	📏	📄
821/A3	110x30 cm 43.3x11.8 in	40 cm 15.7 in	29,7x42 cm 11.6x16.5 in	6,7 Kg 14.7 Lb	A3
821/A4	110x30 cm 43.3x11.8 in	40 cm 15.7 in	21x29,7cm 8.2x11.6 in	5,1 Kg 11.2 Lb	A4

822



Medidas / Sizes

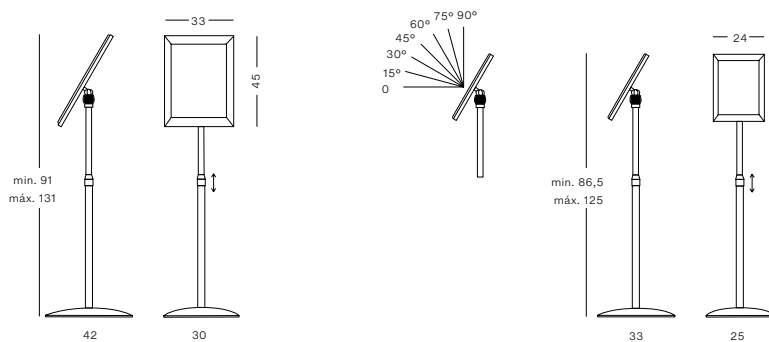

Data

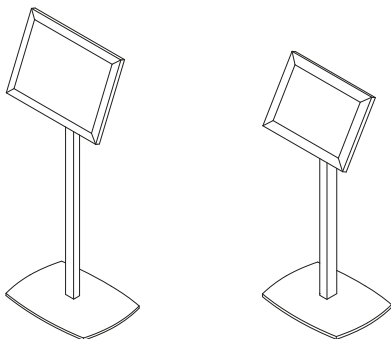

REF	↕ MAX. ~ MIN.	↔	IN	EXT		
822/A3	131 ~ 91 cm 51.5 ~ 35.8 in	42x30 cm 16.5x11.8 in	29,7x42 cm 11.6x16.5 in	33x45 cm 13x17.7 in	6,4 Kg 14.1 Lb	A3
822/A4	125 ~ 86,5 cm 49.2 ~ 34 in	33x24 cm 12.9x9.4 in	21x29,7cm 8.2x11.6 in	24x33 cm 9.4x13 in	6,3 Kg 13.8 Lb	A4

Picture Hanging Rail



Rail de aluminio mural anodizado en color plata mate, para colgar pósters y/o cuadros. Permite cambiarlos sin tener que atornillarlos en la pared y desplazarlos longitudinalmente. Ideales para salas, galerías de arte, exposiciones itinerantes, recepciones, etc. El kit de 200 cm. incluye un juego de 2 cables de nylon y ganchos de sujeción.

Anodized aluminium wall rail in matt silver colour, to hang posters and / or paintings. It allows them to be changed without having to screw them into the wall and move them longitudinally. Ideal for halls, art galleries, traveling exhibitions, receptions, etc. The 200 cm kit includes a set of 2 nylon cables and tie clips.

Rail mural en aluminium anodisé de couleur argent mat, pour accrocher des affiches et / ou des peintures. Il permet de les changer sans avoir à les fixer au mur ou les déplacer longitudinalement. Idéal pour les salles, galeries d'art, expositions itinérantes, réceptions, etc. Le kit de 200 cm. comprend un ensemble de 2 câbles en nylon et des pinces.

Binario da parete in alluminio anodizzato di colore argento opaco, per appendere poster e/o quadri. Permette di cambiarli senza doverli avvitare alla parete e spostarli longitudinalmente. Ideale per sale, gallerie d'arte, mostre itineranti, ricevimenti, ecc. Il kit da 200 cm. Include un set di 2 cavi di nylon e fermagli.

Medidas / Sizes

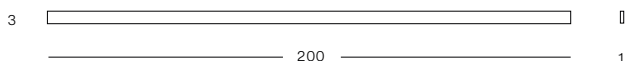

Opciones / Options

REF	↕ ↔	↗ ↖	⚖	
CC/150	3x200 cm 1.1x78.7 in	1 cm 0.3 in	0,3 Kg 0.6 Lb	RAIL + 2 CABLES
CC/1	150 cm 59 in		0,04 Kg 0.08 Lb	JUEGO CABLES.

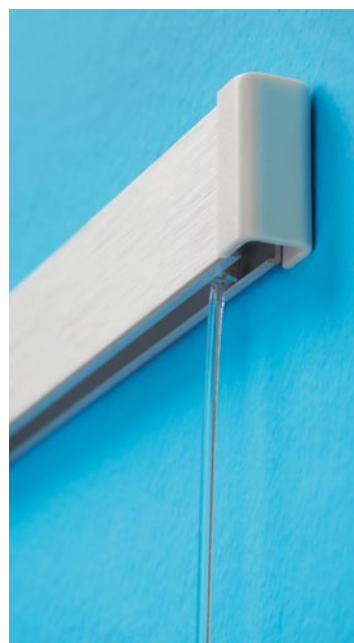
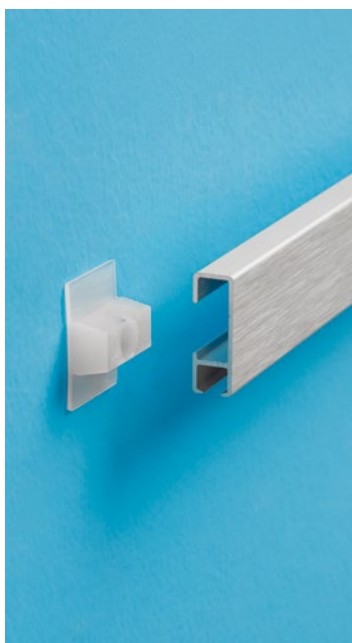

Grid Panel

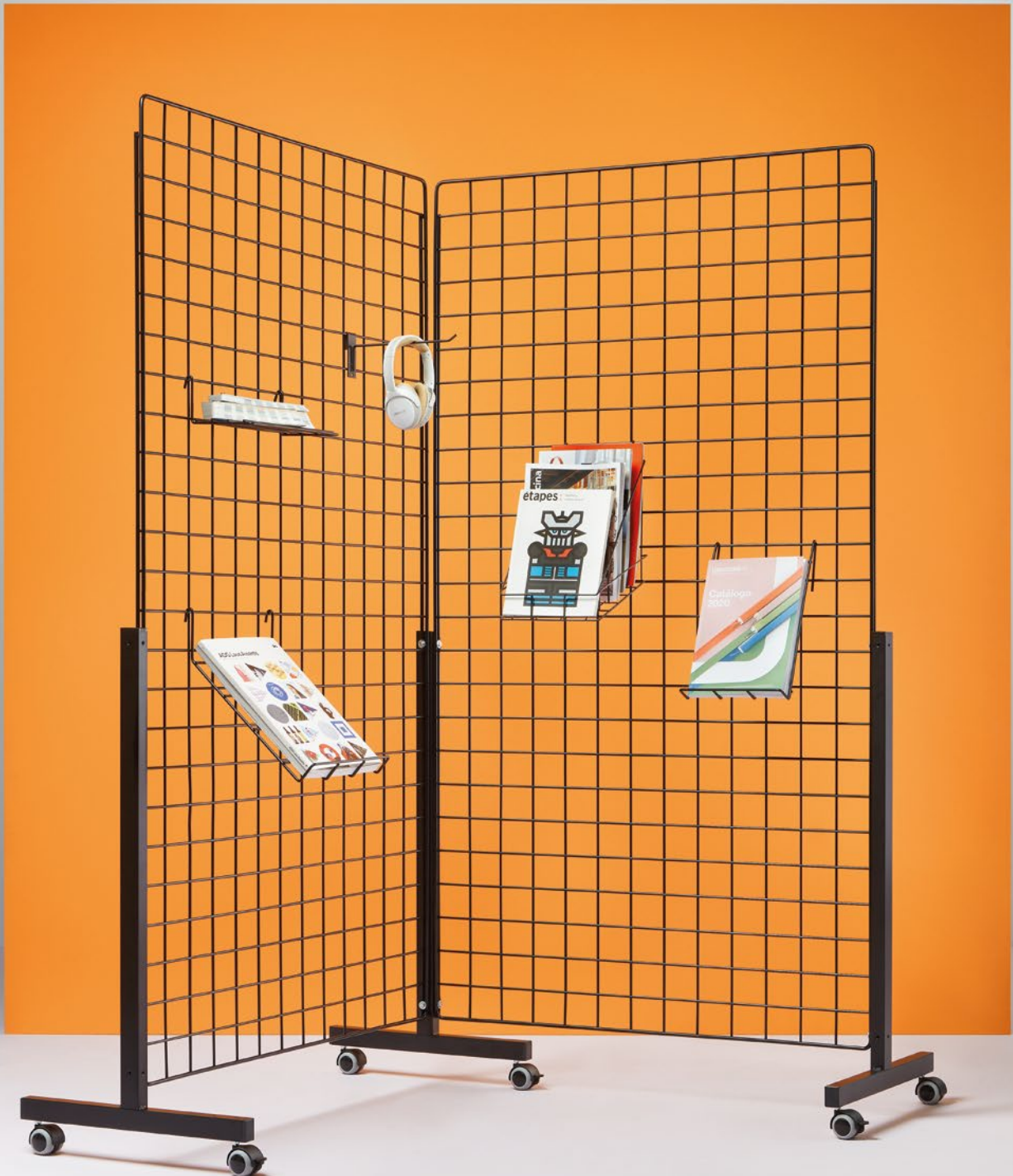

Paneles rejilla metálicos pintados epoxi en color negro, fabricados con varilla de hierro de 0,5 cm. formando una malla de 7x7 cm. Puede colgarse a la pared o montarse con pies forma "T" con ruedas. Sobre el panel podemos situar una extensa gama de accesorios fabricados con la misma varilla metálica. Ideales para comercios, exposiciones...

Black epoxy painted metal grill panels, made of 0.5 cm iron rod forming a 7x7 cm mesh. It can be hung on the wall or mounted with "T" feet with castors. On the panel we can place an extensive range of accessories made with the same metal rod. Ideal for shops, exhibitions...

Grille d'exposition métalliques peintes epoxy noir, fabriquées avec des tiges en fer de 0,5 cm. de grosseur formant une maille de 7x7 cm. Il peut être accroché au mur ou monté avec des pieds en «T» à roulettes. Sur la grille, nous pouvons placer une vaste gamme d'accessoires fabriqués avec la même tige métallique. Idéal pour les boutiques, expositions...

Pannelli grigliati in metallo verniciato con vernice epossidica nera, realizzati con tondino di ferro da 0,5 cm. che formano una maglia di 7x7 cm. Può essere appeso a parete o montato con piedini a "T" con rotelle. Sul pannello è possibile collocare un'ampia gamma di accessori realizzati con lo stesso tondino metallico. Ideale per negozi, mostre...

Medidas / Sizes

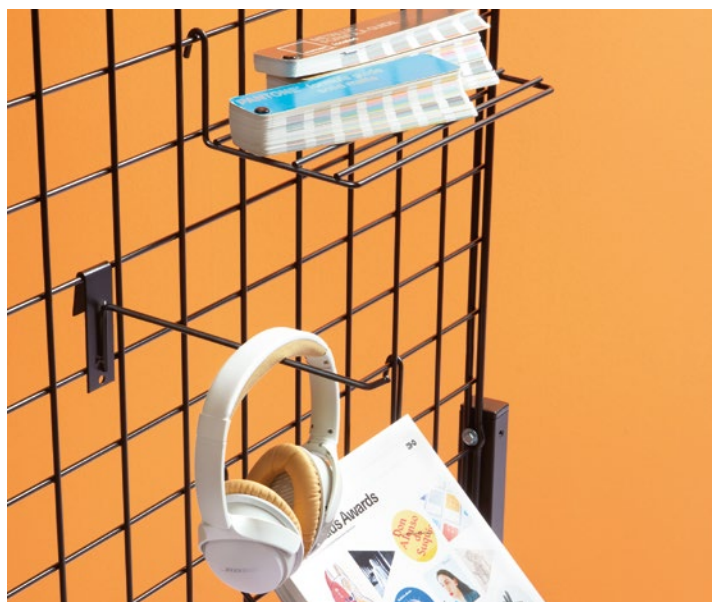
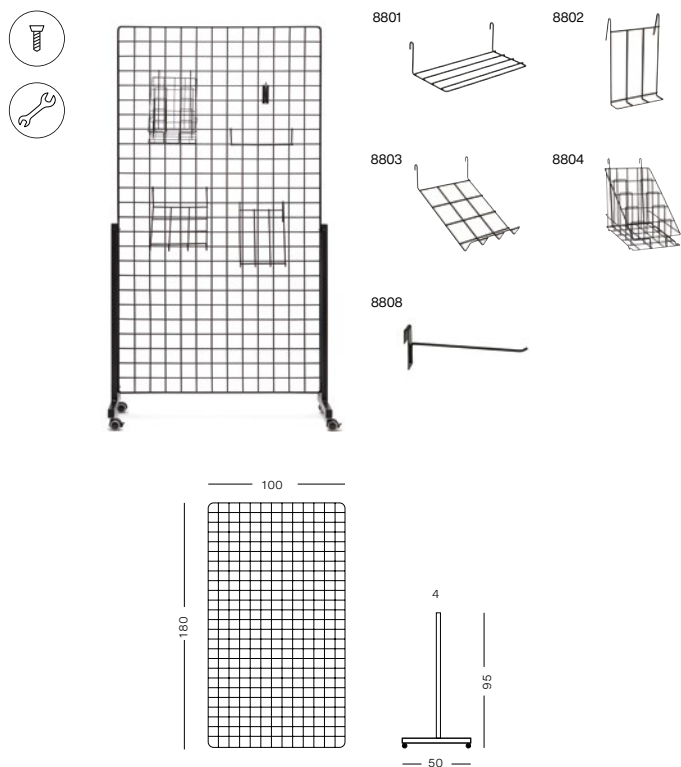

Opciones / Options

REF	↕ ↔	↗ ↖	👤	
880	180x100 cm 70.8x39.3 in	0,5 cm 0.1 in	10 Kg 22 Lb	PANEL REJILLA GRID
881	95x50 cm 37.4x19.6 in	4 cm 1.5 in	4 Kg 8.8 Lb	SOPORTE (1ud.) SUPPORT (1 UNIT)

ACCESORIOS / ACCESSORIES

REF	↕ ↔	↗ ↖	👤	
8801	9,5x30 cm 3.7x11.8 in	14 cm 5.5 in	0,3 Kg 0.6 Lb	ESTANTE SHELF
8802	35x22 cm 13.7x8.6 in	5 cm 1.9 in	0,3 Kg 0.6 Lb	ESTANTE VERTICAL VERTICAL SHELF
8803	5x27 cm 1.9x10.6 in	38 cm 14.9 in	0,4 Kg 0.8 Lb	ESTANTE INCLINADO INCL. SHELF
8804	29,5x22 cm 11.6x8,6 in	24 cm 9.4 in	0,5 Kg 1.1 Lb	PORTAREVISTAS MAGAZINE RACK
8808	9,5x3 cm 3.7x1.1 in	27 cm 10.6 in	0,1 Kg 0.2 Lb	GANCHO HOOK



Contract

Basic Waste Bins - Papeleras Basic	182
Self-Extinguishing Bin - Papeleras Ignífugas	184
Cubic Bin - Papelera Cuadrada	186
Recycling Stations - Contenedores de Reciclaje	188
Inox Pedal Bin - Papeleras Inox con Pedal	192
Outdoor Ashtray - Ceniceros de Exterior	194
Umbrella Stand - Paragüero	198
Planters - Jardineras	200
Fire Extinguisher Holder - Porta Extintor	202
Eco 2 Coat Stand - Perchero Eco 2	204
Eco 4 Coat Stand - Perchero Eco 4	208
Mobile Coat Stand - Perchero Móvil	212
Sign System - Sistema de Señalización	214



En ocasiones usamos como accesorio todo aquello que sobra, que no es primordial o necesario. Nosotros hemos decidido que nuestros accesorios sean no tan solo necesarios sino esenciales, funcionales y estéticos. Basta ya de accesorios escondidos o relegados en lugares poco transitados. La revolución del accesorio ha llegado, elementos que más allá de su funcionalidad consiguen armonizar los espacios para los que han sido creados.

Parfois, nous utilisons comme accessoire tout ce qui reste, ce qui n'est ni essentiel ni nécessaire. Nous avons décidé que nos accessoires sont non seulement nécessaires mais aussi essentiels, fonctionnels et esthétiques. Assez des accessoires cachés ou relégués dans des endroits peu fréquentés. La révolution des accessoires est arrivée, des éléments qui au-delà de leur fonctionnalité parviennent à harmoniser les espaces pour lesquels ils ont été créés.

Sometimes we don't realize the importance of accessories, they are not essential or necessary. At Planning Siplamo we believe that accessories are not only necessary but essential, functional and aesthetic. Enough already of accessories hidden or relegated in places with little traffic. The accessory revolution has arrived, elements that beyond their functionality manage to harmonize the places for which they have been created.

A volte usiamo come accessorio tutto ciò che non è essenziale o necessario. Abbiamo deciso che i nostri accessori non sono solo necessari ma essenziali, funzionali ed estetici. Basta con gli accessori nascosti o relegati in luoghi poco frequentati. È arrivata la rivoluzione degli accessori, elementi che oltre alla loro funzionalità riescono ad armonizzare gli spazi per i quali sono stati creati.

Basic Waste Bins



Gama de papeleras metálicas lisas pintadas epoxi, provistas de aro inferior de PVC antideslizante. Disponibles en 12, 16 y 27 litros, en color blanco, negro o gris. Ideal para puestos de trabajo en oficinas, mostradores o uso doméstico.

Range of smooth metal waste bins painted epoxy, provided with a non-slip PVC bottom ring. Available in 12, 16 and 27 liters and in white, black or grey. Ideal for office workstations, countertops, or home use.

Gamme de corbeilles métalliques peintes avec de la peinture époxy, munies d'un anneau inférieur en PVC antidérapant. Disponible en 12, 16 et 27 litres, en blanc, noir ou gris. Idéal pour les postes de travail de bureau, les comptoirs ou la maison.

Gamma di cestini metallici lisci verniciati con vernice epossidica, dotati di un anello di fondo in PVC antiscivolo. Disponibili in 12, 16 e 27 litri e nei colori bianco, nero o grigio. Ideali per postazioni di lavoro in ufficio, piani di lavoro o per uso domestico.

Medidas / Sizes

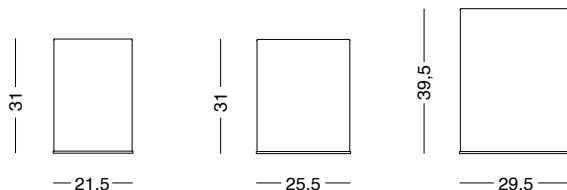

Opciones / Options



Colores / Colours



	●	●	○	↕	∅	⚖	💧
6001/PL	6001/NG	6001/BL	31 cm 12.2 in	21,5 cm 8.4 in	1,1 Kg 2.4 Lb	12 L 3.1 gal	
6002/PL	6002/NG	6002/BL	31 cm 12.2 in	25,5 cm 10 in	1,3 Kg 2.8 Lb	16 L 4.2 gal	
6003/PL	6003/NG	6003/BL	39,5 cm 64.1 in	29,5 cm 11.6 in	2,3 Kg 5 Lb	27 L 7.1 gal	



Self-Extinguishing Bins



Papelera metálica lisa ignífuga pintada epoxi, provistas de aro inferior de PVC antideslizante. Por la forma del cabezal, el posible fuego generado en el interior se auto extingue rápidamente. Disponible standard en color gris. Ideal para puestos de trabajo en oficinas, mostradores o uso doméstico.

Smooth, fire-retardant metal waste bin painted in epoxy, provided with a non-slip PVC bottom ring. Due to the shape of the head, the possible fire generated inside is quickly self-extinguished. Available standard in grey. Ideal for office workstations, countertops, or home use.

Corbeille métallique, ignifuge peinte avec de la peinture époxy, munie d'un anneau inférieur en PVC antidérapant. Grâce à la forme de son couvercle, l'incendie généré à l'intérieur est rapidement auto-éteint. Disponible en gris. Idéal pour les postes de travail, de bureau ou la maison.

Cestino metallico liscio e ignifugo, verniciato in resina epossidica, dotato di un anello di fondo in PVC antiscivolo. Grazie alla forma della testa, l'eventuale incendio generato all'interno si autoestingue rapidamente. Disponibile di serie in grigio. Ideali per postazioni di lavoro in ufficio, piani di lavoro o per uso domestico.

Medidas / Sizes

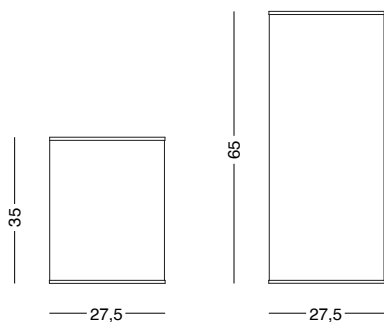

Colores / Colours



Opciones / Options



REF	Height	Width	Weight	Capacity
6022/GR	35 cm 13.7 in	27,5 cm 10.8 in	2 Kg 4.4 Lb	21 L 5.5 gal
6023/GR	65 cm 25.5 in	27,5 cm 10.8 in	3 Kg 6.6 Lb	39 L 10.3 gal

Especificaciones / Specifications

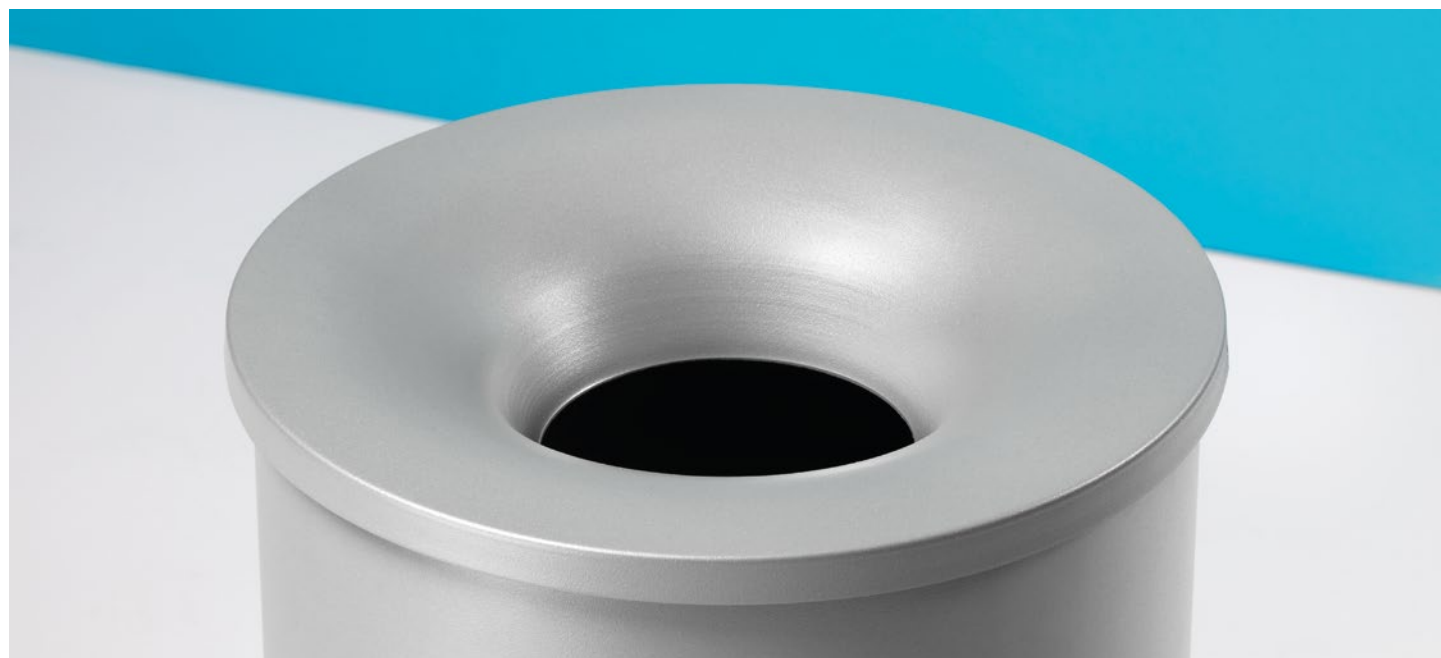

Cubic Bins



Papelera fabricada en chapa metálica pintada epoxi en color blanco con base cuadrada de 30 x 30 cm. Disponible en 3 tamaños para poder adaptar en diferentes espacios según necesidad. 40, 60 y 80 cm. de altura. Color estándar blanco RAL 9003 y posibilidad de elegir el vinilo para el residuo necesario.

Litter bin made with white epoxy painted sheet metal with a 30 x 30 cm square base. Available in 3 sizes to adapt to different areas/uses according to needs. 40, 60 and 80 cm. tall. White standard colour, RAL 9003, and the possibility of choosing the vinyl for the required residues/wastes.

Corbeille métallique peinte avec de la peinture époxy et une base carré de 30 x 30 cm. Disponible en 3 hauteurs pour pouvoir s'adapter dans différents espaces selon les besoins. 40, 60 et 80 cm. Couleur standard blanc RAL 9003 et possibilité de choisir le pictogramme pour le résidu souhaité.

Cestino in lamiera verniciata con vernice epossidica bianca con base quadrata di 30 x 30 cm. Disponibile in 3 misure che consentono di adattarlo a diverse aree/utilizzi a seconda delle esigenze. 40, 60 e 80 cm. Alto. Colore standard bianco RAL 9003 e possibilità di scegliere il vinile per i residui/rifiuti desiderati.

Medidas / Sizes

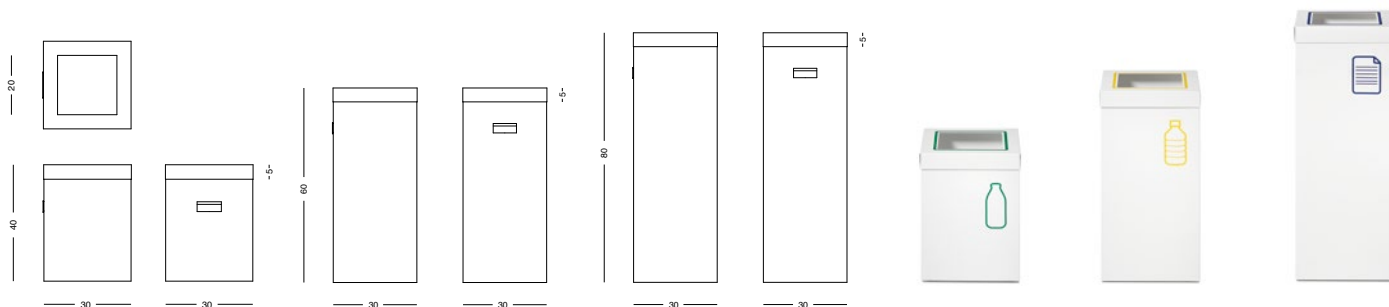

Opciones / Options

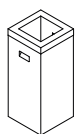

REF	↕ ↔	↔	⚖	💧
6056/1	40x30 cm 15.7x11.8 in	30 cm 11.8 in	3,5 Kg 7.7 Lb	36 L 9.5 gal
6056/2	60x30 cm 23.6x11.8 in	30 cm 11.8 in	5,1 Kg 11.2 Lb	54 L 14.2 gal
6056/2U *Paraguero con bandeja recogeaguas Umbrella stand with drip tray.	60x30 cm 23.6x11.8 in	30 cm 11.8 in	5,1 Kg 11.2 Lb	54 L 14.2 gal
6056/3	80x30 cm 31.4x11.8 in	30 cm 11.8 in	6,6 Kg 14.5 Lb	72 L 19 gal



Recycling Station



Contenedor de reciclaje metálico pintado epoxi blanco o antracita disponible para varios residuos, papelerera con tapa abatible con aros interiores para la sujeción de las bolsas de plástico. Tapa superior con vinilos de colores para la diferenciación de los residuos. Color standard blanco o antracita. Ideal para espacios públicos de gran tráfico de personas.

Metal recycling container, epoxy-painted in white or anthracite, available for various waste types. Trash bin with a hinged lid and inner rings for securing plastic bags. Top lid with colored vinyl for waste differentiation. Standard colors in white or anthracite. Ideal for high-traffic public spaces.

Conteneur de recyclage métallique, peint en époxy blanc ou anthracite, disponible pour différents types de déchets. Poubelle avec couvercle basculant et anneaux intérieurs pour maintenir les sacs en plastique. Couvercle supérieur avec vinyles colorés pour différencier les déchets. Couleurs standard en blanc ou anthracite. Idéal pour les espaces publics à fort trafic de personnes.

Contentore di riciclaggio metallico, verniciato in resina epossidica bianca o antracite, disponibile per vari tipi di rifiuti. Cestino con coperchio ribaltabile e anelli interni per fissare sacchetti di plastica. Coperchio superiore con vinili colorati per differenziare i rifiuti. Colori standard in bianco o antracite. Ideale per spazi pubblici ad alto traffico di persone.



Recycling Station

Opciones / Options



6055/1/BL



6055/1/AN



70x27 cm
27.5x10.6 in



35 cm
13.7 in



8.3 Kg
18.2 Lb



40 L
10 gal

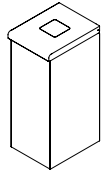

6055/2/BL



6055/2/AN



70x50 cm
27.5x19.6 in



35 cm
13.7 in



16.06 Kg
35.4 Lb



80 L
21 gal

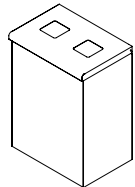

6055/3/BL



6055/3/AN



70x75 cm
27.5x29.5 in



35 cm
13.7 in



24 Kg
52.9 Lb



120 L
31 gal

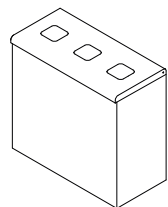

Opciones / Options

↕ ↔
↔
👤
💧

6055/4/BL

6055/4/AN

70x100 cm
27.5x39.3 in

35 cm
13.7 in

32.12 Kg
70.8 Lb

160 L
42 gal

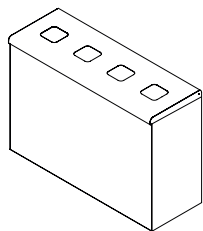

↕ ↔
↔
👤
💧

6055/5/BL

6055/5/AN

70x120 cm
27.5x47.2 in

35 cm
13.7 in

40.15 Kg
88.5 Lb

200 L
52 gal

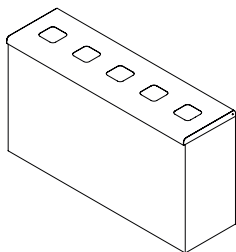

Medidas / Sizes

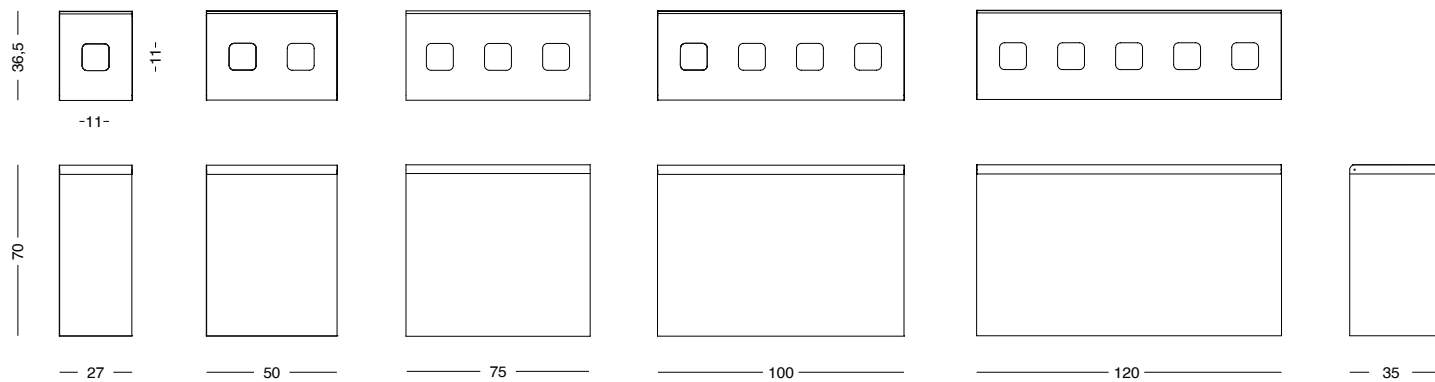

Inox Pedal Bins



Gama de papeleras metálicas con apertura de pedal. Incorporan cubeta de plástico negro con asa y están disponibles en 5, 12, 20 y 30 litros. Fabricadas en acero inoxidable. Ideales para baños tanto para uso en oficinas como doméstico.

Range of metal bins with foot pedal opening. They incorporate a black plastic tray with a handle and are available in 5, 12, 20 and 30 liters. Made of stainless steel. Ideal for bathrooms for both office and domestic use.

Gamme de corbeilles métalliques avec ouverture à pédale. Contient un bac en plastique noir avec poignée et sont disponibles en 5, 12, 20 et 30 litres. Fabriqué en acier inoxydable. Idéal pour les salles de bain du bureau ou domestique.

Gamma di contenitori in metallo con apertura a pedale. Incorporano un vassoio in plastica nera con maniglia e sono disponibili in 5, 12, 20 e 30 litri. Realizzati in acciaio inox. Ideali per i bagni, sia in ufficio che in casa.

Medidas / Sizes

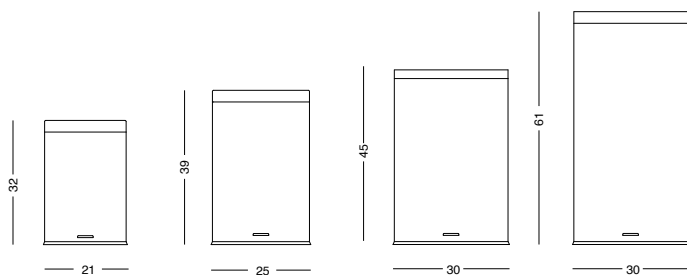

Opciones / Options

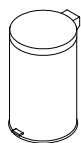

REF	Height	Width	Weight	Capacity
6050/I	32 cm 12.6 in	21 cm 8.3 in	1,2 Kg 2.6 Lb	5 L 1.3 gal
6051/I	39 cm 15.4 in	25 cm 9.8 in	1,9 Kg 4.1 Lb	12 L 3.1 gal
6052/I	45 cm 17.7 in	30 cm 11.8 in	2,7 Kg 5.9 Lb	20 L 5.2 gal
6053/I	61 cm 24 in	30 cm 11.8 in	3,5 Kg 7.7 Lb	30 L 7.9 gal



Outdoor Ashtray



Gama de ceniceros de exterior. Disponibles en 3 modelos a suelo o a pared todos ellos provistos con cerradura de seguridad. Ideal para situar en las entradas de espacios públicos y privados donde no está permitido fumar en el interior. Aptos para intemperie.

Range of outdoor ashtrays. Available in 3 versions floor or wall mounted, all of them provided with a security lock. Ideal for placing at the entrances of public and private places where smoking is not allowed inside. Suitable for outdoors use.

Gamme de cendriers d'extérieur. Disponible 3 modèles différents. Soir muraux ou au sol, tous équipés d'une serrure de sécurité. Idéal pour placer aux entrées des espaces publics et privés. Résistant aux intempéries.

Gamma di posacenere da esterno. Disponibile in 3 versioni da terra o da parete, tutte dotate di serratura di sicurezza. Ideali per essere collocati all'ingresso di luoghi pubblici e privati dove non è consentito fumare all'interno. Adatti alle intemperie.



Outdoor Ashtray

BL/MO/0050



Size

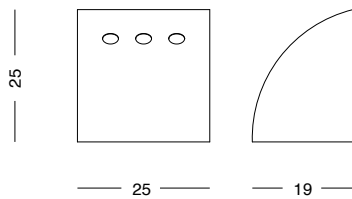

Data

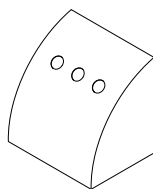

REF	↕↔	↔	⚖	💧
BL/MO/0050	25x25 cm 9.84x9.84 in	19 cm 7.48 in	2,1 Kg 4.6 Lb	1,4 L 3 gal

BL/MO/0051



Size

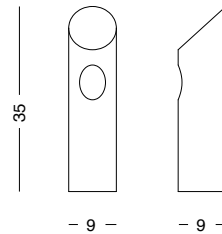

Data

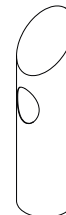

REF	↕	∅	⚖	💧
BL/MO/0051	35 cm 13.8 in	9 cm 3.54 in	1,5 Kg 3.3 Lb	0,6 L 1.3 gal

BL/MO/0052



Size

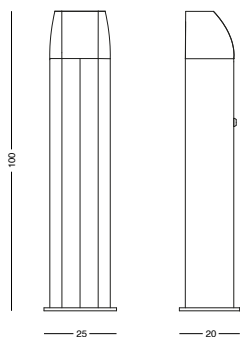

Data

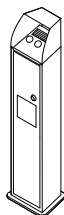

REF	↕ ↔	↔	👤	💧
BL/MO/0052	100x25 cm 39.3x9.8 in	20 cm 7.8 in	13 Kg 28.6 Lb	4,4 L 1.1 gal
	Ashtray capacity			1,2 L 0.3 gal
	Waste paper capacity			4,3 L 1.1 gal



Paragüero



Paragüero de construcción metálica de gran capacidad para paraguas largos y plegables. Contiene dos espacios según el tamaño. Dispone de cubeta inox o cataforesis resistente al agua. Disponible en blanco y antracita.

Large-capacity metal umbrella stand for both long and foldable umbrellas. Features two compartments based on size. Equipped with a stainless steel or water-resistant cataforesis tray. Available in white and anthracite

Porte-parapluie métallique grande capacité pour parapluies longs et pliables. Doté de deux compartiments en fonction de la taille. Équipé d'un bac en acier inoxydable ou d'une cuve cataforesis résistante à l'eau. Disponible en blanc et anthracite.

Portaombrelli in metallo di grande capacità per ombrelli lunghi e pieghevoli. Dispone di due scomparti in base alle dimensioni. Dotato di vassoio in acciaio inossidabile o trattato con cataforesi resistente all'acqua. Disponibile in bianco e antracite.

Especificaciones / Specifications

Medidas / Sizes

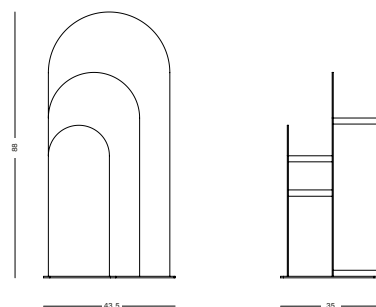

Colores / Colours



Data

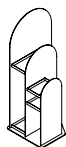

REF
6070/02

COLORES / COLOURS
○ /BL ● /AN



88x43.5 cm
34.6x17.1 in



35 cm
13.7 in



12 Kg
26.4 Lb

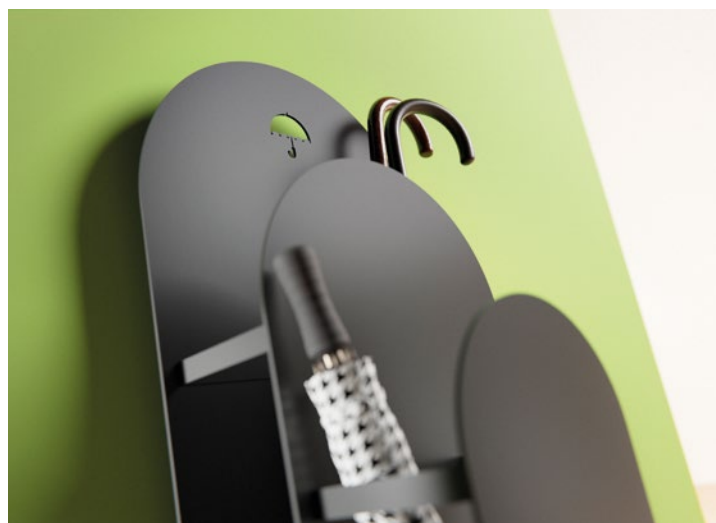

Jardineras



Colección de jardineras fabricadas en chapa galvanizada resistentes al agua. Disponible en 2 tamaños y 2 alturas, son ideales para ubicar en zonas de interior.

Collection of garden planters made of galvanized sheet metal, water-resistant. Available in 2 sizes and 2 heights, they are ideal for placement in indoor areas.

Collection de jardinières fabriquées en tôle galvanisée résistant à l'eau. Disponibles en 2 tailles et 2 hauteurs, elles sont idéales pour être placées dans des zones intérieures

Collezione di fioriere da giardino realizzate in lamiera zincata resistente all'acqua. Disponibili in 2 dimensioni e 2 altezze, sono ideali per essere posizionate in zone interne.

Especificaciones / Specifications

Medidas / Sizes

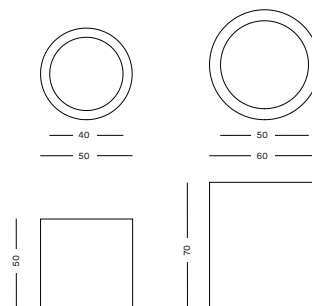

Colores / Colours



Data



REF
6400/01

COLORES / COLOURS
○ /BL ● /AN



50x Ø50 cm
19.6x Ø19.6 in



14 Kg
30.8 Lb



0.15 cm
0.08 in

6400/02

70x Ø60 cm
27.5x Ø23.6 in

22 Kg
48.5 Lb

0.15 cm
0.08 in



Porta Extintor



Porta extintor metálico provisto de ruedas para colocar de manera cómoda un extintor. Puede colocarse sujeto a la pared o colocado con ruedas al suelo. Disponible en 2 colores, blanco y antracita.

Metal fire extinguisher holder with wheels for convenient placement of a fire extinguisher. Can be wall-mounted or placed on the floor with wheels. Available in 2 colors, white and anthracite.

Support métallique pour extincteur avec roues pour un placement pratique. Peut être fixé au mur ou placé sur le sol avec des roues. Disponible en 2 couleurs, blanc et anthracite.

Sostegno metallico per estintore con ruote per un posizionamento comodo. Può essere montato a parete o posizionato a terra con le ruote. Disponibile in 2 colori, bianco e antracite.

Especificaciones / Specifications

Medidas / Sizes

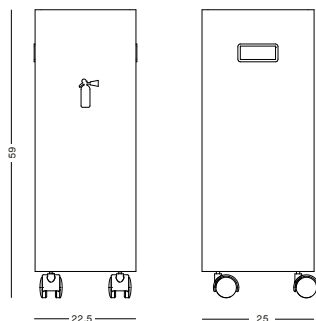

Colores / Colours

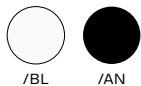

Data

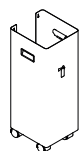

REF
6300/01

COLORES / COLOURS
○ /BL ● /AN



59x22.5 cm
23.2x8.85 in



5.3 Kg
11.6 Lb



25 cm
9.84 in



Eco 2 Coat Stand



Perchero/paragüero metálico de tubo redondo de ø 4 cm. y de gran ligereza y estabilidad gracias a su base. 4 ganchos dobles en su parte superior pintados en colores antracita y blanco. Ideal para espacios de trabajo y el habitat. Disponibles en versión mural de 1, 3, 4 o 6 perchas

Metal coat rack / umbrella stand made of ø 4 cm round tubular steel lightweight giving stability thanks to its base. 4 double hooks on the upper part painted in anthracite and white colours. Ideal for workplaces and home. Also available in wall mounted version with 1, 3, 4 or 6 hangers.

Porte-manteau / porte-parapluie métallique en tube rond ø 4 cm. et d'une grande légèreté et stabilité grâce à sa base. 4 patères doubles sur la partie supérieure peints en anthracite ou blanc. Idéal pour les espaces de travail et l'habitat. Disponible en version murale avec 1, 3, 4 ou 6 patères.

Appendiabiti / portaombrelli in metallo realizzato in tubo tondo ø 4 cm leggero e stabile grazie alla sua base. 4 ganci doppi sulla parte superiore verniciati nei colori antracite e bianco. Ideale per luoghi di lavoro e abitazioni. Disponibile in versione da parete con 1, 3, 4 o 6 ganci.



Eco 2 Coat Stand

EC/02

EC/12

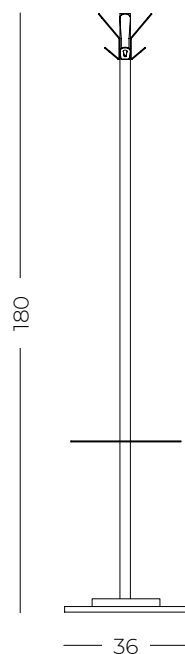
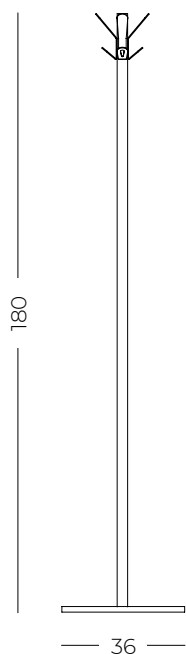



Especificaciones / Specifications







Colores / Colours



Data

					
EC/02/BL	EC/02/AN	180 cm 70.8 in	36 cm 14.1 in	8	9 Kg 19.8 Lb

Data

					
EC/12/BL	EC/12/AN	180 cm 70.8 in	36 cm 14.1 in	8	11,3 Kg 24.9 Lb

EC/P

EC/02/M

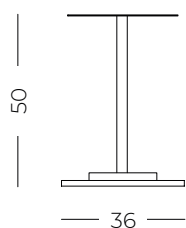





Especificaciones / Specifications



Colores / Colours



Data





				
EC/P/BL	EC/P/AN	50 cm 17.7 in	36 cm 14.1 in	6 Kg 13.2 Lb

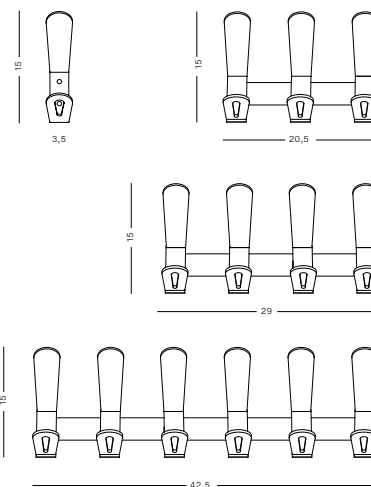

Medidas / Sizes



Data

				
EC/02/M1/BL	EC/02/M1/AN	15x3,5 cm 5.9x15.3 in	1	0,1 Kg 0.2 Lb
EC/02/M3/BL	EC/02/M3/AN	15x20,5 cm 5.9x8 in	3	0,5 Kg 1.1 Lb
EC/02/M4/BL	EC/02/M4/AN	15x29 cm 5.9x11.4 in	4	0,7 Kg 1.5 Lb
EC/02/M6/BL	EC/02/M6/AN	15x42,5 cm 5.9x16.7 in	6	1 Kg 2.2 Lb

Eco 4 Coat Stand



Perchero/paragüero metálico de tubo redondo de \varnothing 3 cm. y de gran ligereza y estabilidad gracias a su base. 5 perchas dobles en su parte superior pintados en colores antracita y blanco. Ideal para espacios de trabajo y el hábitat. Disponibles en versión mural de 3, 4 o 6 perchas.

Metal coat rack / umbrella stand made of \varnothing 3 cm round tube. This lightweight and stability is thanks to its base. 5 upper double hangers painted in anthracite and white. Ideal for workplaces and home. Also available in a wall mounted version with 3, 4 or 6 hangers.

Porte-manteau / porte-parapluie métallique en tube rond \varnothing 3 cm. et d'une grande légèreté et stabilité grâce à sa base. 5 patères doubles sur la partie supérieure peintes en anthracite ou blanc. Idéal pour les espaces de travail et l'habitat. Disponible en version murale avec 3, 4 ou 6 patères.

Appendiabiti / portaombrelli in metallo realizzato in tubo tondo \varnothing 3 cm. La leggerezza e la stabilità sono dovute alla sua base. 5 appendini doppi superiori verniciati nei colori antracite e bianco. Ideale per i luoghi di lavoro e per la casa. Disponibile in versione da parete con 3, 4 o 6 appendini.



Eco 4 Coat Stand

EC/04

EC/14

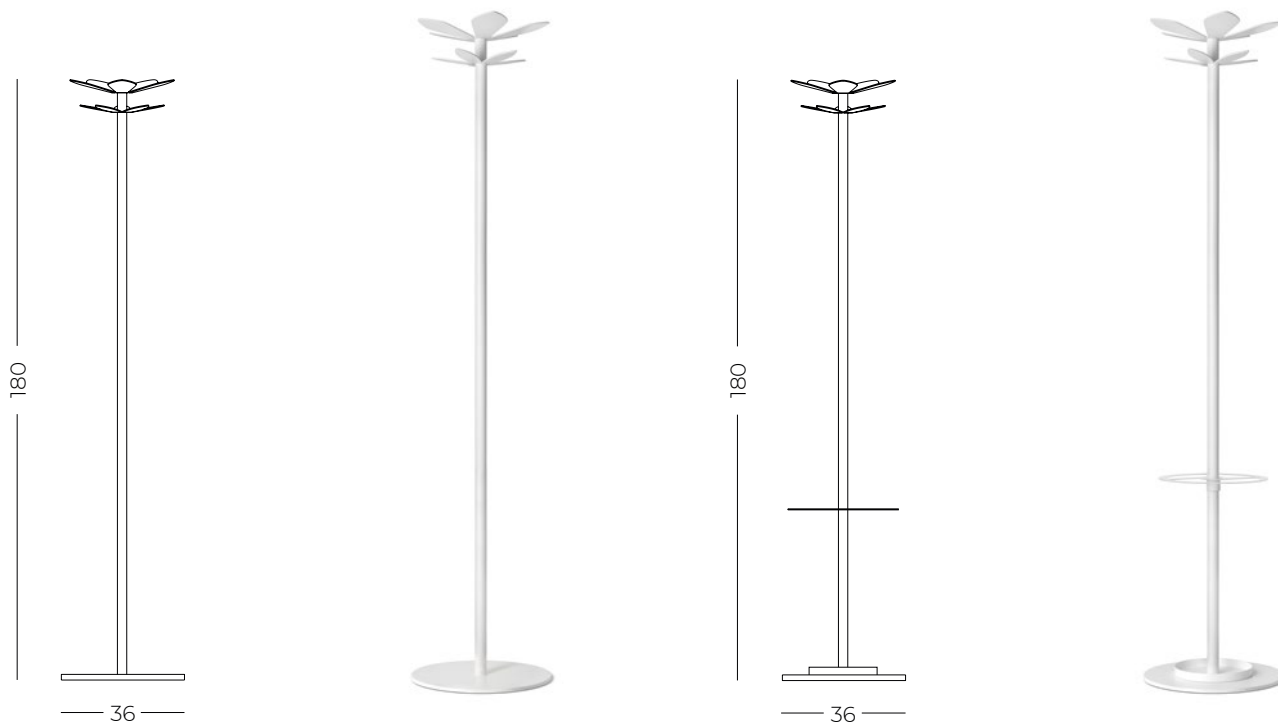

Especificaciones / Specifications







Colores / Colours



Data

					
EC/04/BL	EC/04/AN	180 cm 70.8 in	36 cm 14.1 in	10	9 Kg 19.8 Lb

Data

					
EC/14/BL	EC/14/AN	180 cm 70.8 in	36 cm 14.1 in	10	11,3 Kg 24.9 Lb

EC/P

EC/04/M

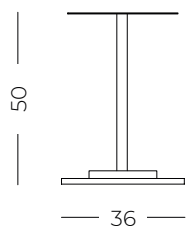





Especificaciones / Specifications



Colores / Colours



Data





				
EC/P/BL	EC/P/AN	50 cm 19.7 in	36 cm 14.1 in	6 Kg 13.2 Lb

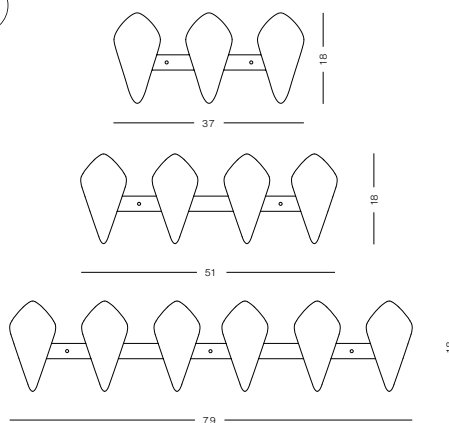

Medidas / Sizes



Data

				
EC/04/M3/BL	EC/04/M3/AN	18x37 cm 7x14.5 in	3	0,7 Kg 1.5 Lb
EC/04/M4/BL	EC/04/M4/AN	18x51 cm 7x20 in	4	1 Kg 2.2 Lb
EC/04/M6/BL	EC/04/M6/AN	18x79 cm 7x31.1 in	6	1,5 Kg 3.3 Lb

Mobile Coat Stand



Perchero metálico pintado epoxi blanco bastidor con ruedas de estructura demontable para transporte o almacenaje. La parte inferior incorpora un estante para colocar bolsos, maletas, cascos... Ideal en oficinas, aulas, guardarropas...

White epoxy painted metal coat stand with removable frame with castors for transport or storage. The lower part incorporates a shelf to place bags, suitcases, helmets... Ideal in offices, classrooms...

Porte-manteau métallique peint en peinture époxy blanche avec châssis amovible et roulettes pour le transport ou le stockage. La partie inférieure intègre une étagère pour ranger sacs, valises, casques... Idéal dans les bureaux, salles de classe, vestiaires...

Appendiabiti in metallo verniciato con vernice epossidica bianca, con struttura smontabile dotata di rotelle per il trasporto o lo stoccaggio. La parte inferiore incorpora un ripiano per riporre borse, valigie, caschi... Ideale in uffici, aule...

Medidas / Sizes

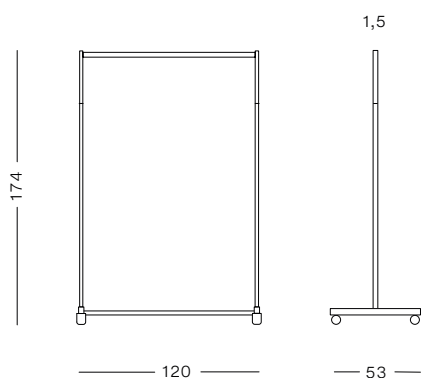

Especificaciones / Specifications



Data

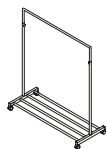

REF	↕ ↔	↔	⚖
TS/BUR/R	174x120 cm 68.5x47.2 in	53 cm 20.8 in	5 Kg 11 Lb



Signage System

GgHh

GgHhIj

GgHhIjKkLl

GgHhIjKkLlMm

GgHhIjKkLlMmNnÑñ

Consectetur adipiscing elit

1 Lorem ipsum dolor sit amet

2 Lorem ipsum dolor sit amet

3 Lorem ipsum dolor sit amet

4 Lorem ipsum dolor sit amet

Aa

AaBbCcDd

Zz

OoPpQq

Rr

Sistema de señalización de perfil curvo para pictogramas y rótulos para fijación en techo o pared. Está fabricado con perfil de aluminio anodizado en color plata mate. El soporte permite la incorporación del papel (pictograma o texto). Mediante una ventosa especial se levanta el plástico protector para intercambiar la información. Ideal para señalización de interiores. Disponible en diferentes largos y 6 alturas distintas.

Curved profile signaling system for pictograms and labels for fixing to the ceiling or wall. It is made of anodized aluminium profile in matt silver colour. The support allows the incorporation of the paper (pictogram or text). By means of a special suction cup the protective plastic is lifted to exchange the information. Ideal for indoor signage. Available in different lengths and 6 different heights.

Système de signalétique avec profil courbe pour pictogrammes et étiquettes à fixer au plafond ou au mur. Profilé en aluminium anodisé de couleur argent mat. Le support permet l'incorporation du pictogramme ou du papier texte. Grâce à une ventouse spéciale incluse, le plastique de protection est soulevé pour échanger les informations. Idéal pour la signalisation intérieure. Disponible en différentes longueurs et 6 hauteurs différentes.

Sistema di segnalazione a profilo curvo per pittogrammi ed etichette da fissare a soffitto o a parete. È realizzato con un profilo in alluminio anodizzato di colore argento opaco. Il supporto permette di incorporare il pittogramma o la carta di testo. Grazie a una speciale ventosa, la plastica protettiva viene sollevata per scambiare le informazioni. Ideale per la segnaletica interna. Disponibile in diverse lunghezze e 6 altezze.



Signage System

793/M (wall)

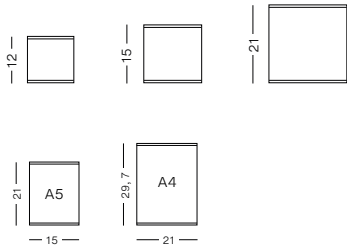

793/P (double sided flag)

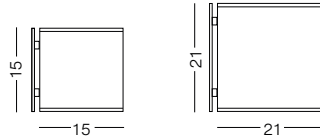

Opciones / Options

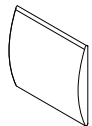

REF	↕ ↔	↗ ↖	⚖
793/M/12	12x12 cm 4.7x4.7 in	1 cm 0.3 in	0,2 Kg 0.4 Lb
793/M/15	15x15 cm 5.9x5.9 in	1,2 cm 0.4 in	0,2 Kg 0.4 Lb
793/M/21	21x21 cm 8.2x8.2 in	1,4 cm 0.5 in	0,4 Kg 0.8 Lb
793/M/A5	21x15 cm 8.2x5.9 in	1,2 cm 0.4 in	0,4 Kg 0.8 Lb
793/M/A4	29,7x21 cm 11.6x8.2 in	1,4 cm 0.5 in	0,6 Kg 1.4 Lb

Opciones / Options



REF	↕ ↔	↗ ↖	⚖
793/P/15	15x15 cm 5.9x5.9 in	2,4 cm 0.9 in	1,3 Kg 2.8 Lb
793/P/21	21x21 cm 8.2x8.2 in	2,8 cm 1.1 in	1,9 Kg 4.1 Lb



799/SB (desk)



799/P (double sided flag)

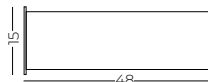
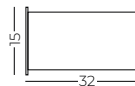
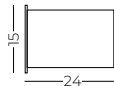
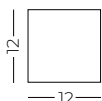
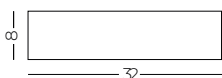
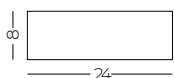
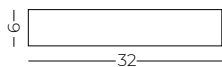
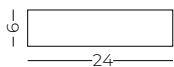

Opciones / Options

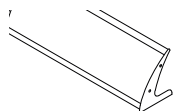

REF	↕ ↔	↗ ↖	⚖
799/6/24/SB	6x24 cm 2.3x9.4 in	0,8 cm 0.3 in	0,2 Kg 0.4 Lb
799/6/32/SB	6x32 cm 2.3x12.5 in	0,8 cm 0.3 in	0,2 Kg 0.4 Lb
799/8/24/SB	8x24 cm 3.1x9.4 in	1 cm 0.3 in	0,3 Kg 0.6 Lb
799/8/32/SB	8x32 cm 3.1x12.5 in	1 cm 0.3 in	0,3 Kg 0.6 Lb
799/12/12/SB	12x12 cm 4.7x4.7 in	1 cm 0.3 in	0,5 Kg 1.1 Lb

Opciones / Options

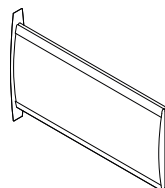

REF	↕ ↔	↗ ↖	⚖
799/15/24/P	15x24 cm 5.9x9.4 in	2,4 cm 0.9 in	1,2 Kg 2.6 Lb
799/15/32/P	15x32 cm 5.9x12.5 in	2,4 cm 0.9 in	1,4 Kg 3 Lb
799/15/48/P	15x48 cm 5.9x18.8 in	2,4 cm 0.9 in	2 Kg 4.4 Lb

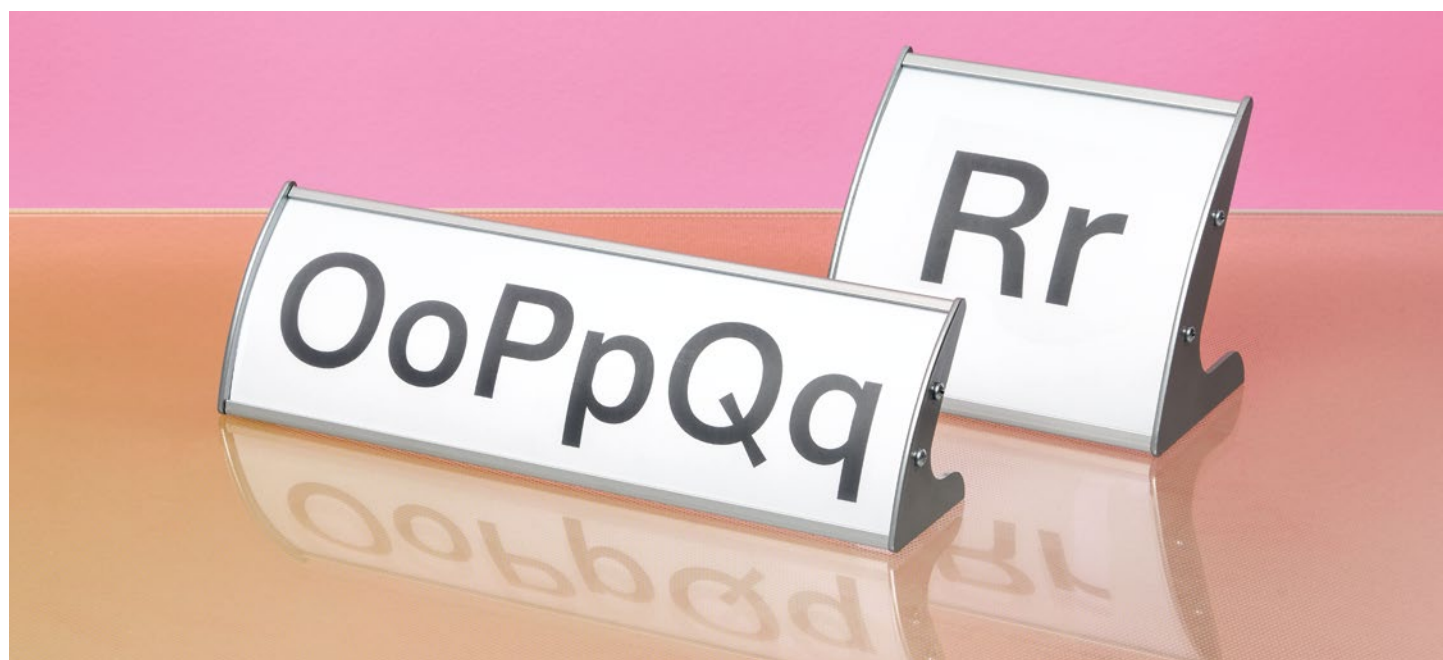

Signage System

799/S (suspended)

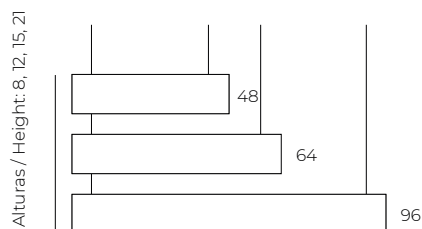

Opciones / Options

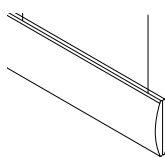

REF			
799/8/48/S	8x48 cm 3.1x18.8 in	2 cm 0.7 in	0,68 Kg 1.4 Lb
799/8/64/S	8x64 cm 3.1x25.1 in	2 cm 0.7 in	0,88 Kg 1.9 Lb
799/8/96/S	8x96 cm 3.1x37.7 in	2 cm 0.7 in	1,36 Kg 3 Lb
799/12/48/S	12x48 cm 4.7x18.8 in	2 cm 0.7 in	1,25 Kg 2.7 Lb
799/12/64/S	12x64 cm 4.7x25.1 in	2 cm 0.7 in	1,56 Kg 3.4 Lb
799/12/96/S	12x96 cm 4.7x37.7 in	2 cm 0.7 in	2,45 Kg 5.4 Lb
799/15/48/S	15x48 cm 5.9x18.8 in	2,4 cm 0.9 in	1,6 Kg 3.5 Lb
799/15/64/S	15x64 cm 5.9x25.1 in	2,4 cm 0.9 in	2,1 Kg 4.6 Lb
799/15/96/S	15x96 cm 5.9x37.7 in	2,4 cm 0.9 in	3,2 Kg 7 Lb
799/21/48/S	21x48 cm 8.2x18.8 in	2,4 cm 0.9 in	2,1 Kg 4.6 Lb
799/21/64/S	21x64 cm 8.2x25.1 in	2,4 cm 0.9 in	2,6 Kg 5.7 Lb
799/21/96/S	21x96 cm 8.2x37.7 in	2,4 cm 0.9 in	4,1 Kg 9 Lb

799/M (wall)

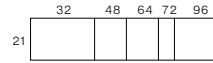
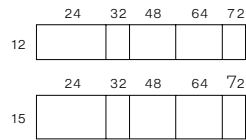
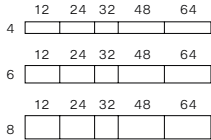

Opciones / Options

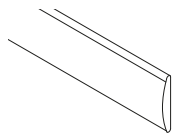

REF	↕ ↔	↗ ↖	⊖	REF	↕ ↔	↗ ↖	⊖
799/4/12/M	4x12 cm 1.5x4.7 in	0,8 cm 0.3 in	0,04 Kg 0.1 Lb	799/15/72/M	15x72 cm 5,9x28.3 in	1,2 cm 0.4 in	1,5 Kg 3.3 Lb
799/4/24/M	4x24 cm 1.5x9.4 in	0,8 cm 0.3 in	0,08 Kg 0.2 Lb	799/21/32/M	21x32 cm 8.2x12.5 in	1,2 cm 0.4 in	0,6 Kg 1.3 Lb
799/4/32/M	4x32 cm 1.5x12.5 in	0,8 cm 0.3 in	0,11 Kg 0.2 Lb	799/21/48/M	21x48 cm 8.2x18.8 in	1,2 cm 0.4 in	1 Kg 2.2 Lb
799/4/48/M	4x48 cm 1.5x18.8 in	0,8 cm 0.3 in	0,2 Kg 0.4 Lb	799/21/64/M	21x64 cm 8.2x25.1 in	1,2 cm 0.4 in	1,3 Kg 2.9 Lb
799/4/64/M	4x64 cm 1.5x25.1 in	0,8 cm 0.3 in	0,2 Kg 0.5 Lb	799/21/72/M	21x72 cm 8.2x28.3 in	1,2 cm 0.4 in	1,6 Kg 3.5 Lb
799/6/12/M	6x12 cm 2.3x4.7 in	0,8 cm 0.3 in	0,06 Kg 0.1 Lb	799/21/96/M	21x96 cm 8.2x37.7 in	1,2 cm 0.4 in	1,5 Kg 3.3 Lb
799/6/24/M	6x24 cm 2.3x9.4 in	0,8 cm 0.3 in	0,1 Kg 0.3 Lb				
799/6/32/M	6x32 cm 2.3x12.5 in	0,8 cm 0.3 in	0,18 Kg 0.4 Lb				
799/6/48/M	6x48 cm 2.3x18.8 in	0,8 cm 0.3 in	0,27 Kg 0.6 Lb				
799/6/64/M	6x64 cm 2.3x25.1 in	0,8 cm 0.3 in	0,3 Kg 0.6 Lb				
799/8/12/M	8x12 cm 3.1x4.7 in	1 cm 0.3 in	0,08 Kg 0.17 Lb				
799/8/24/M	8x24 cm 3.1x9.4 in	1 cm 0.3 in	0,17 Kg 0.8 Lb				
799/8/32/M	8x32 cm 3.1x12.5 in	1 cm 0.3 in	0,2 Kg 0.4 Lb				
799/8/48/M	8x48 cm 3.1x18.8 in	1 cm 0.3 in	0,34 Kg 0.7 Lb				
799/8/64/M	8x64 cm 3.1x25.1 in	1 cm 0.3 in	0,4 Kg 0.9 Lb				
799/8/96/M	8x96 cm 3.1x37.7 in	1 cm 0.3 in	0,66 Kg 1 Lb				
799/12/24/M	12x24 cm 4.7x9.4 in	1 cm 0.3 in	0,3 Kg 0.6 Lb				
799/12/32/M	12x32 cm 4.7x12.5 in	1 cm 0.3 in	0,4 Kg 0.8 Lb				
799/12/48/M	12x48 cm 4.7x18.8 in	1 cm 0.3 in	0,6 Kg 1.3 Lb				
799/12/64/M	12x64 cm 4.7x25.1 in	1 cm 0.3 in	0,7 Kg 1.5 Lb				
799/12/72/M	12x72 cm 4.7x28.3 in	1 cm 0.3 in	1,2 Kg 2.6 Lb				
799/15/24/M	15x24 cm 5.9x9.4 in	1,2 cm 0.4 in	0,4 Kg 0.8 Lb				
799/15/32/M	15x32 cm 5.9x12.5 in	1,2 cm 0.4 in	0,5 Kg 1.1 Lb				
799/15/48/M	15x48 cm 5.9x18.8 in	1,2 cm 0.4 in	0,8 Kg 1.7 Lb				
799/15/64/M	15x64 cm 5.9x25.1 in	1,2 cm 0.4 in	1 Kg 2.2 Lb				

Annex

Iconos

Rotulable
Inscribable
Inscriptable
Graffiabile



No rotulable
Not Inscriptable
Non-inscriptable
Non graffiabile



Escritura con tiza
Chalk writing
Ecriture à la craie
Scrittura con gesso



Trazo digital
Digital use
Trait digital
Uso digitale



Blocs de papel
Paper blocs
Blocs du papier
Blocchi di carta



Personalizable
Customizable
Personalisé
Personalizzabile



Magnético
Magnetic
Magnétique
Magnetico



No magnético
Not magnetic
Non-magnétique
Non magnetico



Pinchable
Suitable for pins
Aptes aux punaises
Adatto per i perni



Adhesivo
Adhesive
Adhésif
Adesivo



Doble cara
Double sided
Double face
Doppio lato



Herrajes incluidos
Fitting included
Ferrures inclus
Raccordi inclusi



Puerta abatible vertical
Vert. swing door
Portes battante vertical
Porta a battente verticale



Puerta abatible horizontal
Hor. swing door
Portes battante horizontal
Porta a battente orizzontale



Incluye ruedas
Castors included
Avec roulettes
Include ruote



Nivelador
Leveller
Niveleur
Livellatrice



Ajustable en altura
Adjustable height
Régable en hauteur
Altezza regolabile



Volteable
Flip - flop
Volteable
Flippable



Puerta corredera
Sliding doors
Portes coulissantes
Porte scorrevoli



Incluye cerradura
Lock included
Serrure incluse
Include serratura



Sistema de seguridad
Security system
Serrure de sécurité
Sistema di sicurezza



Resistente al agua
Water resistant
Resistant à l'eau
Impermeabile



No inflamable
Not flammable
Non-inflammable
Non infiammabile



Kit de iluminación
Light kit
Kit lumière
Kit di illuminazione



Antibacteriano
Antibacterial
Antibactérien
Antibatterico



Incluye herramientas
Tools included
Visserie inclus
Include strumenti



Ajustable en altura de base
Adjustable base
Socles ajustables
Altezza della base regolabile



Acústico
Acoustic
Acoustique
Acustico



Colores

Writeboards

Marcos y Soportes



Glass Board

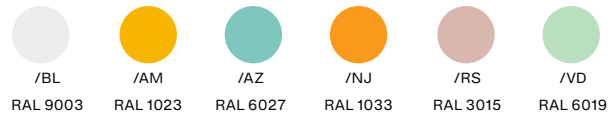

Pinboards

Pinboards Textiles



Chameleon Pinboards



Chameleon Glass



Partitions

Antibacteriales



Contract

Papeleras



Colores

Acoustic

PFA Panel



FELT colors





**Planning
Sisplamo**

Headquarters

Polígono Industrial Pla d'en Coll
Camí de la Font Freda 17, Nave 4
08110 Montcada i Reixac
Barcelona, Spain

T. +34 935 616 595
comercial@planningsisplamo.com
www.planningsisplamo.com

follow us
[@planningsisplamo_ps](https://www.instagram.com/planningsisplamo_ps)

Credits

Concept and Art Direction
The Office of Samuel Lopez

Photography
Befree Studio

Attrezzo
Kave Home
Akaba
JG Group
Emmegi by Frezza



**We love
our planet.**

Printed with
100% recycled
paper

